



Transport Guide

Business parcel express, Business parcel, Pick-up parcel, Home delivery parcel plus and Business groupage and Business partloads.

Valid from February 1, 2025



We find new ways for you and your customers

This Transport Guide describes our parcel and groupage services for the private and business markets, including terms and conditions, zone table and price lists.

We hope our Transport Guide will be of use to you!

Part 1 Parcels, pp. 4-20

Part 2 Groupage loads and partloads, pp. 21-39

Part 3 Zonetables and prices, pp. 40-180



Bring and the environment

As a Bring customer, you are already making a good environmental choice today. We also have a structured and targeted plan to become even better in the future.

Posten Bring has set industry-leading climate goals

As a major Nordic transport and logistics player, we know that we are part of the challenge and therefore a part of the solution. We want to take leadership in our industry and have set ambitious climate goals.

Posten Bring has already reduced CO2 emissions by 62% from 2012 to 2024, and now we have increased our ambition. By 2030, all our vehicles will be electric or powered by biogas.

Our goals in 2030

Posten Bring will be a driving force in the transition to a low-emission society. This means that we will have ambitious goals and a realistic plan to achieve them.

In 2021, Posten Bring was the first logistics player in Norway to set science-based targets in line with the Paris Agreement. Already in 2023, we revised these goals and now have industry-leading climate goals approved by the Science Based Targets initiative:

- Reduce absolute emissions from our own vehicles and buildings by 85% compared to 2022
- Reduce absolute emissions from all goods and services by 30% compared to 2022
- Reduce 90-95% of emissions from the entire business to achieve net zero by 2040

Our Action Plan to reach them

Posten Bring has been electrifying our vans for many years and has over 2000 electric vehicles. By combining these, over 50% of Norway’s population is served by electric vans. Going forward, we aim to electrify van distribution in the 60 most populous municipalities. This means we will reach 70% of Norway’s population with electric vans. Our goal is to electrify all owned and leased vans by the end of 2027.

We have started the electrification journey for heavier vehicles and have around 200 electric trucks and biogas trucks in operation, with more on order. We have also established a national charging network for heavy vehicles, with over 200 fast chargers from Narvik in the north to Kristiansand in the south. In some places, our

charging network is also offered to our partners. Our goal is to establish corridors between the largest cities with vehicles using fossil-free energy sources by the end of 2026. All our trucks will be electric or use biogas by 2030.

The most important measure to reduce emissions from our operations is to avoid distances driven. Therefore, Posten Bring continuously works to optimize our routes, increase consolidation and load factor, and modernize terminal structures with co-location. We use trains where possible and convert heavy vehicles connected to trains to offer intermodal solutions with only fossil-free energy sources.

Increased electrification requires more energy. Therefore, we are installing solar panels at our terminals, and this has been established at 18 of our terminals in the Nordics. Our goal is to install solar panels at half of our terminals by the end of 2026.

Posten Bring was the first logistics player to issue green bonds. These are favourable loans that must be used for emission-reducing measures.

From 2021 to 2024, Posten Bring has issued 4.5 billion. Detailed information about Posten Bring’s emissions and our emission-reducing measures can be read in our annual report.



Part 1 Parcels

OUR SERVICES

- 1.1 Services p. 5-6
- 1.2 Additional services pp. 6-8
- 1.3 Additional information on services pp. 8-9
- 1.4 Posting, collection and delivery pp. 9-11

CONDITIONS FOR TRANSPORT

- 1.5 Terms and conditions pp. 11-13

LIABILITY AND INSURANCE

- 1.6 Liability of the customer and Bring pp. 13-16
- 1.7 Transport conditions pp. 16-19
- 1.8 Claims and compensation pp. 19-20



1.1 Our services

Our customers have many different needs. This is why we offer a range of services to meet every need for logistics services – from A to Z.

1.1.1 E-services

Transport with Bring entails access to a number of e-services. In addition to integration directly with our IT-system, we offer our customers Mybring, an online selfservice solution that gives you full control of your deliveries with Bring, wherever you are located. With a single sign-on, you can easily generate customised reports and order parcel, freight and courier shipments. Now also with GPS coordinates for all services.

Mybring is available 24 hours a day, and is free of charge for Bring customers. Our IT-solutions comply with all the standards and requirements set out in the common system for the identification of freight of 1 July 2000 issued by the Norstella Foundation and EAN Norway. The solution communicates with most EDI-system suppliers. Consignments that do not fulfil the requirements may be rejected, delayed or subject to an additional charge.

Error messages or errors in EDI-messages are corrected by Bring. Invoicing for errors will be charged to the freight payer in accordance with the applicable prices.

1.1.2 Business parcel

Parcels up to 35 kg actual weight from business to business requires a staffed business place to receive the parcel. Delivery is between 08:00-16:00. Parcels can be dropped off at Post in Shop or parcel locker, for pricing, see section 3.4.4. For collection, you as a customer can create a fixed collection agreement or order an ad-hoc pick-up, see section 3.4.5.

By default, your recipients will have several options; the parcel can be left at the delivery address if the recipient is not at the office when the driver arrives, or the parcel can be redirected. The receiver is in such case offered to redirect the parcel to a local pickup point or a parcel locker. The recipient can then pick up the parcel when it suits within the pickup deadline. These additional services are particularly suitable for small and medium-sized businesses that may not have staffed reception when the package arrives. Both additional services are free.

Note! You as the sender can reserve the right for the recipient to not have this option.



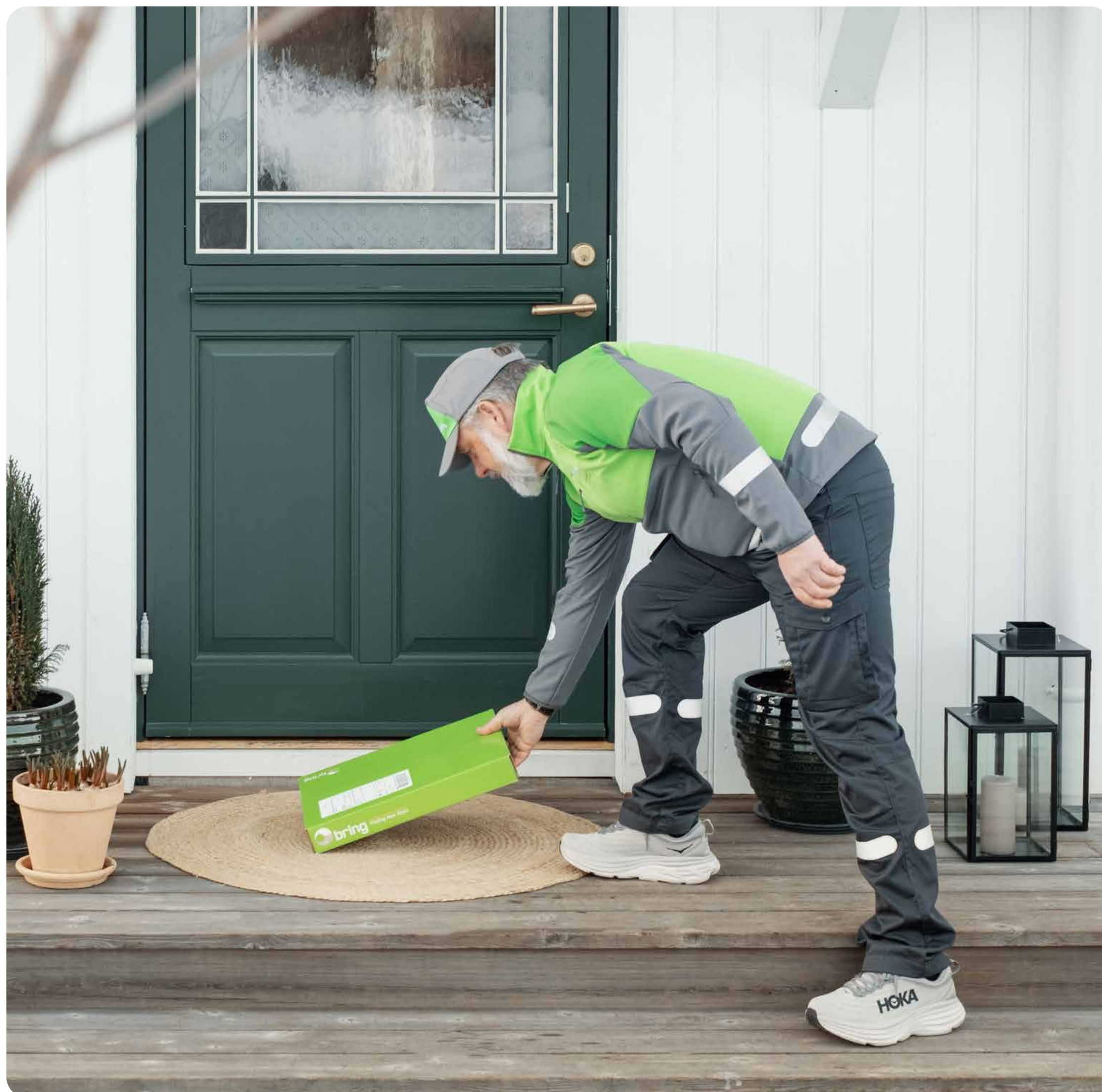

1.1.3 Business parcel express

Our offer when express delivery of parcels of up to 35 kg actual weight is important. For more information, see section 1.4.2.

1.1.4 Pick-up parcel

Parcels of up to 35 kg actual weight as an agreement-based service for businesses that target private customers (online stores, etc.). Bring is committed to reducing greenhouse gas emissions from transport operations, utilising rail instead of transportation by road, and also compensating for the remaining emission.

1.1.5 Parcels delivered home

Parcels of up to 35 kg actual weight as an agreement-based service for business customers with private customers as their target group. The parcel is delivered to the recipient's home during daytime hours between 08:00-17:00, or evening hours between 17:00-21:00, based on street address and postcode. Your customer will receive notification that the parcel is on its way, with the expected delivery date.

For parcels delivered in the evening, the customer can track the parcel and a smaller delivery window will be notified. The recipient can change the delivery date, or authorise Posten and Bring to leave the parcel at the recipient's risk if no one is present upon the time of delivery. We deliver with GPS coordinates for tracking on Mybring.

1.2 Additional Parcel Services

Bring offers additional services that add value for customers. Some of these services are presented below. Other additional services are shown in the price lists and at bring.no.

1.2.1 Optional pick-up point

The recipient can choose from which pick-up point to collect the parcel. This additional service can be used for the Pick-up parcel and Business parcel express services. The service is well suited for online shopping.

1.2.2 Cash on delivery (Pick-up parcel)

The additional service guarantees that the parcel is only delivered if the amount has been paid. Suitable when you have agreed that the customer will pay for the item you are sending.

If you wish to change or delete the COD-amount while the parcel is underway, you can place the order in Mybring and pay a surcharge. The service can also be used for Business Parcel Bulk, and single parcels for the Faroe Islands and Greenland. See section 3.4.2 Surcharges.

1.2.3 Simplified delivery

This is a service whereby the sender can ask Bring to leave the goods at the recipient's premises or, by ordering e-notification, the recipient can order simplified delivery without the recipient being

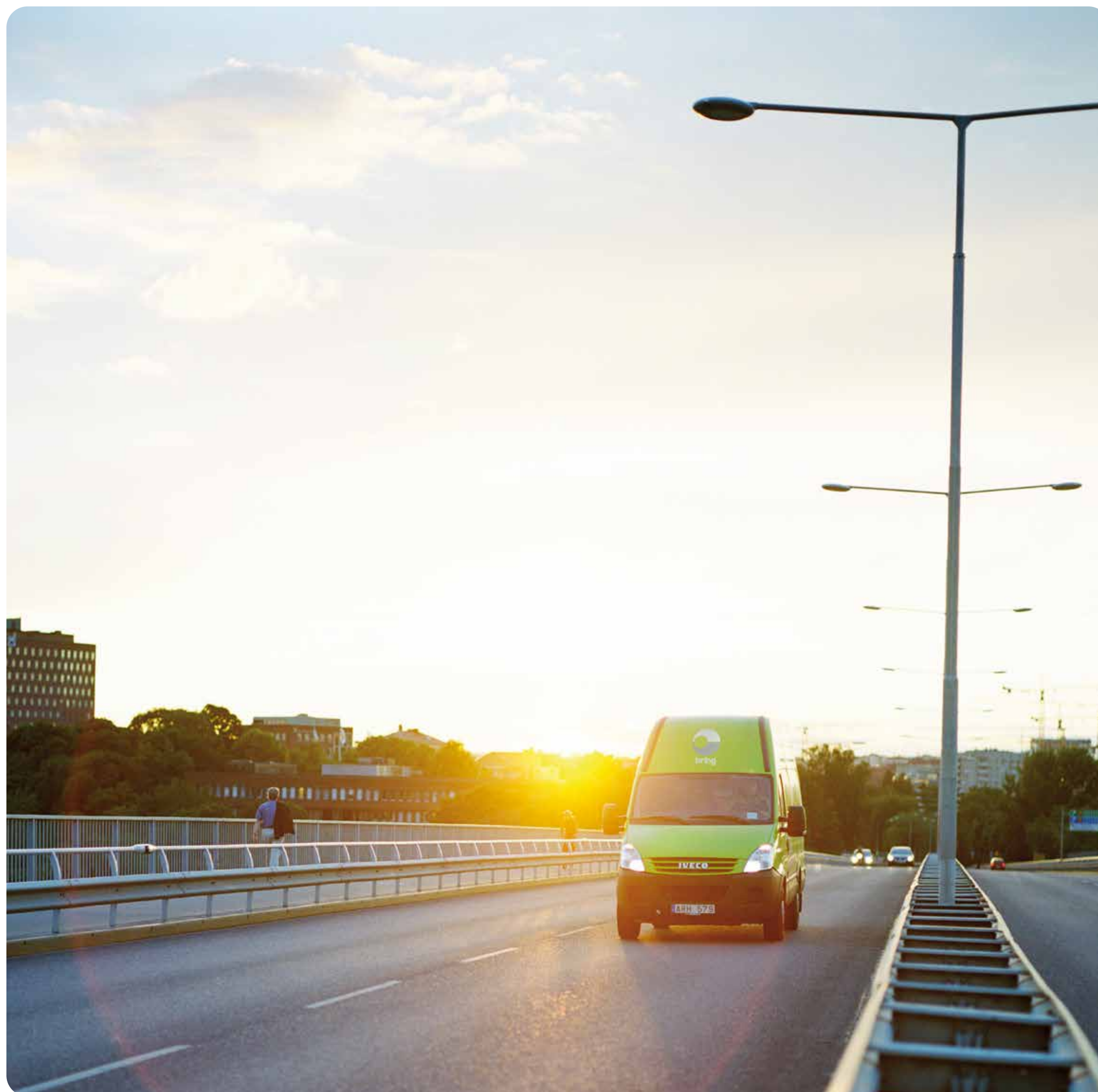

present to accept the delivery. The service must be ordered via EDI-message. As agreed with the sender or recipient, the driver leaves the goods at street level and the driver registers that the goods have been delivered, thereby ensuring the traceability of the consignment. This service entails that the customer accepts the associated risk with regard to liability and waives the right to compensation in the event of damage and loss.

Simplified delivery is not recommended in large cities or for apartment blocks unless Bring can deliver the goods in an enclosed entrance or similar. It must be possible to leave the parcel so as not to infringe the applicable fire regulations. The value of the goods should also be taken into consideration.

This service is not appropriate for readily marketable goods that can easily be removed.

1.2.4 Proof of identity services

If you want the recipient to present proof of identity on delivery, you can order this via EDI. Your recipient will receive a notification that your business wants them to present proof of identity. This additional service can be used for all parcel services.

Delivery against ID:

Proof of identity is checked on delivery. A person other than the recipient may collect the parcel, but must provide proof of identity for the parcel to be

issued to them. Can be used for all parcel services. For prices, see section 3.4.1 Additional services

Personal delivery:

Only the specified recipient may collect the parcel – by presenting proof of identity. A power of attorney cannot be used. Can be used for Business parcel express, Home delivery parcel plus and Pick-up parcel.

1.2.5 Projects

We offer transport and logistics solutions adapted to a project that is limited in time or volume. Priced according to agreement.

1.2.6 Deployment of expertise

In cooperation with our customers, we analyse possible areas in which we can improve the customer's logistics efficiency through extended cooperation.

Bring currently offers dedicated personnel with training and experience in the logistics area who, together with our customers, can analyse and identify measures to improve the customer's logistics efficiency. Examples of the areas covered are delivery follow-up and handling, transport planning and execution, coordination with the customer's warehouse, procurement and sales department, and coordination and arrangement of all forms of incoming and outgoing transport, regardless of form of transport and destination.

1.2.7 Insurance

It is possible to take out goods insurance for parcels. For parcels, this takes place via EDI-message. For more details, see bring.no

1.2.8 Notification

Ordered via EDI. The service entails that we agree the time of delivery with the recipient. Priced separately.

1.3 Additional Information Services

1.3.1 Additional Flex service

Flex or Redirect

Replacement offers our customers the flexibility of sending consignments to companies, by providing the recipient the option of having the parcel delivered, even if no one is present at the destination when the driver arrives. Documentation of handover is available via the Mybring portal or a link & code sent by e-mail.

Rerouting means that the shipment is delivered to the local Post-i store or parcel box, and can be picked up by the recipient there.

Ordering Flex or Rerouting

No additional integrations are required. The service can be ordered in the Posten app in

Norway (the Bring app in SE/DK), on the tracking page and in the recipient portal in Mybring. The sender can book the flex service 0041 through their regular booking, e.g. Mybring or through another TM - provider. When booking transport an e-notification is included, and the recipient is given two options:

Reinstatement: The consignment is left outside the target destination even if the recipient is not available to receive the consignment.

Or **Redirection:** The package is redirected to the local pick up point in store or parcel locker. These services are free of charge, reduces the environmental impact of Co2 emissions and also cost reductions.

Conditions for reinstatement

- The supplier is free from liability for any damage to the consignment or any loss related to this after the consignment has been delivered.
- Authorisation to leave the package at the target destination has to comply with the applicable fire regulations.
- After handing over the shipment, the recipient is responsible for the consignment.
- A receipt will be sent by SMS upon delivery.
- This service is available for Business Parcel, Groupage, Business Parcel, Business Parcel Bulk, Business pallet, delivered between 08:00 and 21:00, that usually requires a



signature from the recipient upon delivery.

- This service is not recommended in larger cities or apartment buildings without secured gates.
- Not suitable for consignments that require identification, payment, or are temperature-sensitive (e.g., pharmaceuticals).
- The sender can block the ability to choose Flex.
- Please note that the responsibility of informing the recipient about terms and conditions of the services solely relies on the customer (sender).

1.3.2 Collection deadline

The collection deadline for parcels from a post office in Norway is 7 days. Parcels that are not collected within the deadline are returned. A reminder is sent to the recipient after 3 days. Using text message, push- or email notifications, a reminder is sent on day 3 and day 6 after arrival at Post in Shops, parcel box or post office.

Parcels that arrive at post offices or Post in Shops between 1 and 17 July will not be returned before 1 August. During the period from 23 to 31 December parcels will not be returned. The first day of return is the third business day after New Year.

1.3.3 Consignments that are returned

Consignments that are unable to be delivered to the recipient will be returned at the customer's expense.

1.3.4 Delivery precision and calculation of delivery time

We have an indicative delivery time for our services, unless otherwise stated as a condition for the individual service. The delivery time runs from the registration of the consignment's arrival at our sender terminal until it is delivered to/made available to the recipient. The promised delivery time for Business parcel express can be found at Mybring.no in the booking screen.

For other services, the delivery time is solely measured as the number of days. Bring currently offers a time guarantee for Business parcel express.

Assumptions:

- Correct labelling and packaging of the goods, and correct EDI-messages received and accepted by Bring before we receive the consignment.
- The consignment must be registered at the delivery terminal within the delivery deadline for the relevant service and terminal. Delivery can take place from Monday to Friday, normally between 08:00-16:00.

Exceptions:

- Weekends and public holidays, as well as holiday periods, and in the event of force majeure situations, such as floods, landslides, snowfalls or other reduced accessibility of roads or railways.





1.3.5 Goods not carried by Bring

Unless otherwise agreed, parcels may not contain precious metals, valuables, weapons, ammunition, live animals, larvae, insects or similar, remnants, removal goods, unpackaged goods, customs passport consignments or cigarettes/ tobacco products.

1.4 Posting, collection and delivery

Bring can collect all consignments from the sender and deliver them to the recipient. Shipments are considered as collected when they are scanned as handed in at Post in Shops or terminals. Parcels can be posted/collected at Post in Shops/post offices. There are various options, service levels and deadlines for our services, and these are priced according to the applicable service specifications and price lists.

If you order collection of freight for more than NOK 450 on the same day and from the same address, collection will be included in the freight price. This requires the use of a customer number and collection on the same date.

For collection of freight below this amount, a surcharge for small collection will be added to the freight charge. See section 3.4.6 Surcharges.

1.4.1 Business parcel

Parcels can be dropped off at a Post in Shop (for an additional fee) or a parcel locker.

Parcels are primarily collected and delivered at one location within the business, such as reception or a ramp. Consignments will not be carried in by the driver. Delivered to the recipient from Monday to Friday before 16:00. Two delivery attempts are made at the recipient's address. If two delivery attempts are made, a surcharge will apply; see the price list. It is possible to order delivery via Post in Shops or a post office if the recipient is not present when delivery to the door is attempted. This must be ordered at the same time as the EDI-message. This service can be performed after the first or second delivery attempt. The service is priced separately and only applies when the parcels have been delivered via a post office.

See the price list for Business parcels. Parcels with an actual weight exceeding 35 kg, or consignments with more than 4 package, cannot be delivered via Post in Shops or a post office and will be returned to the sender if we are unable to deliver the parcels. If the parcel cannot be delivered to the door and delivery via a pick-up point (Post in Shops or a post office) has been ordered, the recipient will be notified via a collection notice in the form of a letter or text message.



1.4.2 Business parcel express

Business parcel express parcels can be included on collection of other parcel services when parcel collection has been agreed. A separate collection agreement may also be entered into regarding Business parcel express parcels.

If Business parcel express parcels are collected together with other parcel services, they must be clearly separated from other parcels, for prioritised manufacturing. This is to ensure correct handling and faster delivery. Business parcel express parcels can also be posted from Post in Shops or post offices. Please note that separate posting deadlines may apply to this service.

Dry ice may not be sent as Business parcel express. Business parcel express can be delivered as Business parcels to one location at the recipient's premises. The services do not include internal distribution at the recipient's premises, with delivery to several locations in the building.

Ordinary Business parcel express delivery is from Monday to Friday before 09:00, 11:30 or 16:00, depending on the distance and the postcode. For parcels with a delivery deadline before 09:00, a second delivery attempt is made before the parcels are made available at a pick-up point. Parcels with delivery deadlines of 11:30 or 16:00 are made available at a pick-up point after the first delivery attempt.

1.4.3 Pick-up parcel

For customers without a pick-up agreement, parcels can be posted at a post office or Post in Shops. Parcels are delivered via post offices, Post in Shops or rural postmen/postwomen. See also the section on pick-up deadlines.

1.4.4 Consignments to Svalbard and Spitsbergen

Parcels (less than 35 kg, max. size 120x60x60 cm) are sent by air. For all transport by air, separate rules apply to dangerous goods, see section 1.7.1 Safety regulations. Parcels that cannot be consigned by air are shipped. Parcels with a net value exceeding NOK 5,000 require customs clearance. Parcels to Svalbard must have a standard transport label, and a commercial invoice (possibly a proforma invoice) must accompany the consignment. There are fixed surcharges for freight to Svalbard. See section 3.4.5 Additional services.

1.4.5 Parcels delivered home

The parcels can be posted at Post in Shops or post offices for an additional charge per package. The parcel will be delivered to the recipient's home from Monday to Friday in the evening between 17:00-21:00 in towns and built-up areas, and between 08:00 and 17:00 elsewhere. See the updated table at bring.no.

We also pilot weekends in selected areas. Your customer will be notified of the expected delivery date well in advance, with a tracking link, via text

message or email. A delivery attempt is made at the recipient's address, and if the recipient is not present or leaving the parcel has not been ordered, the parcel will be delivered to the customer's nearest pick-up point. Two delivery attempts can be ordered; see the price list. This must be ordered at the same time as the EDI-messages.

1.4.6 Limitations and impediments concerning transport

Some postcodes may have limited options for collection and delivery, even within the same postcode.

Examples might be:

- Local barriers
- Cabin areas
- Islands with limited ferry services
- Other geographical areas where Bring does not have normal driving routes, e.g. mountain areas or other areas subject to seasonal restrictions.

Senders and recipients with addresses in such areas must expect deviations in delivery times. Areas where accessibility is reduced, senders can deliver parcels in post office or Post in Shops and recipients will have their parcels delivered to pick up point.

1.5 Terms and conditions for Parcels

To ensure correct handling, it is important that the conditions for using the individual service are fulfilled. Our terms and conditions can be regarded as part of the agreement for the individual transport.

Validity

Posten Bring AS distributes goods under the Bring brand name. Transport is undertaken in accordance with the tariff rates, freight calculation regulations and transport terms and conditions applicable to Bring.

Bring's transport terms and conditions are governed by the general provisions of the Nordic Forwarders Association (NSAB), the Norwegian Road Carriage Contracts Act (Act concerning road freight agreements), the Norwegian Maritime Code and our Transport Guide for parcels, groupage and partloads on a national basis.

Bring waives all liability for the customer's further use of data supplied by Bring, either directly or via third parties. Approved information about each consignment and package that is assumed to be scanned in accordance with agreed standards or transferred electronically comprises the agreement/transport contract for the individual consignment. The parcels will be loaded together

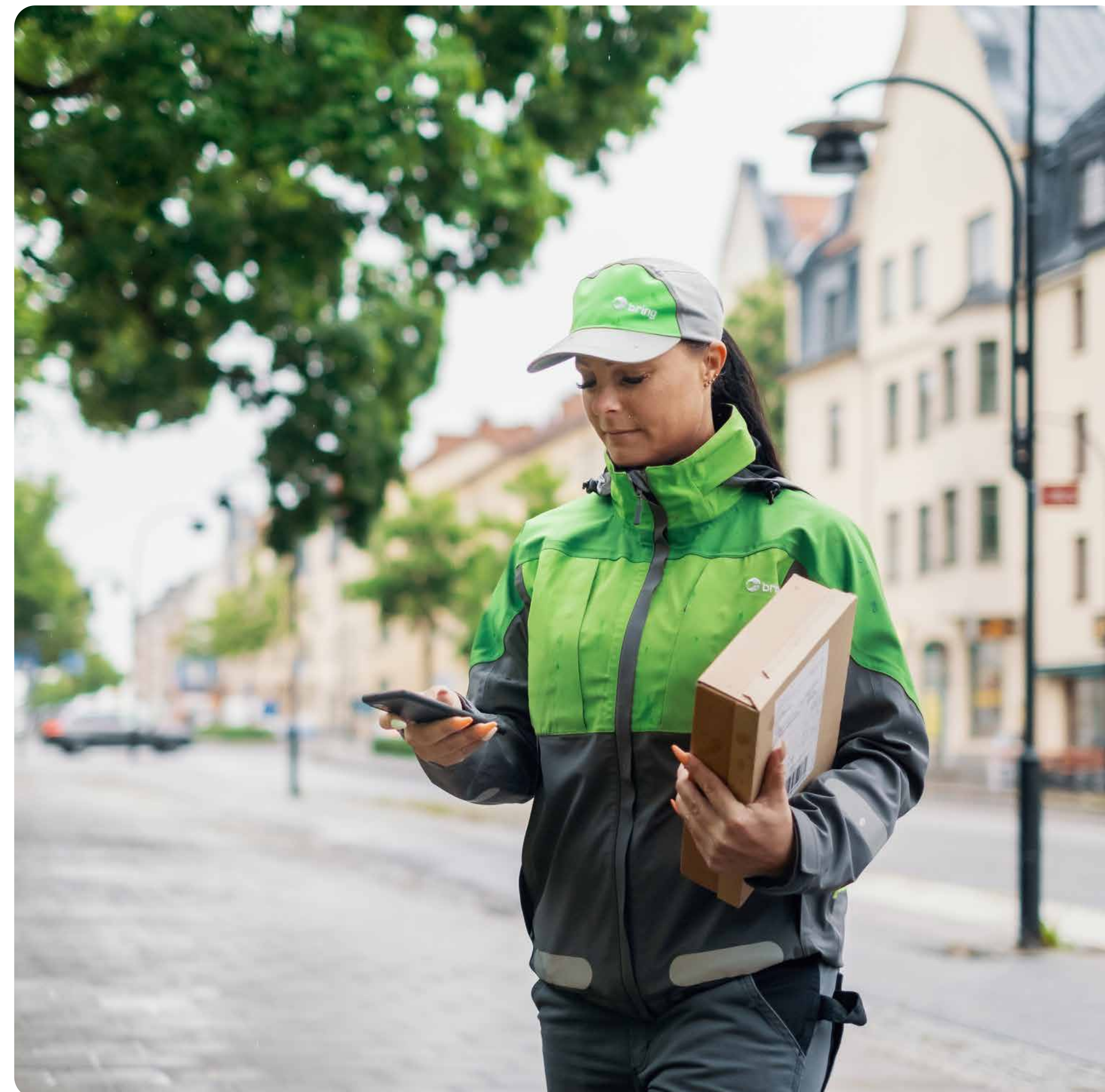

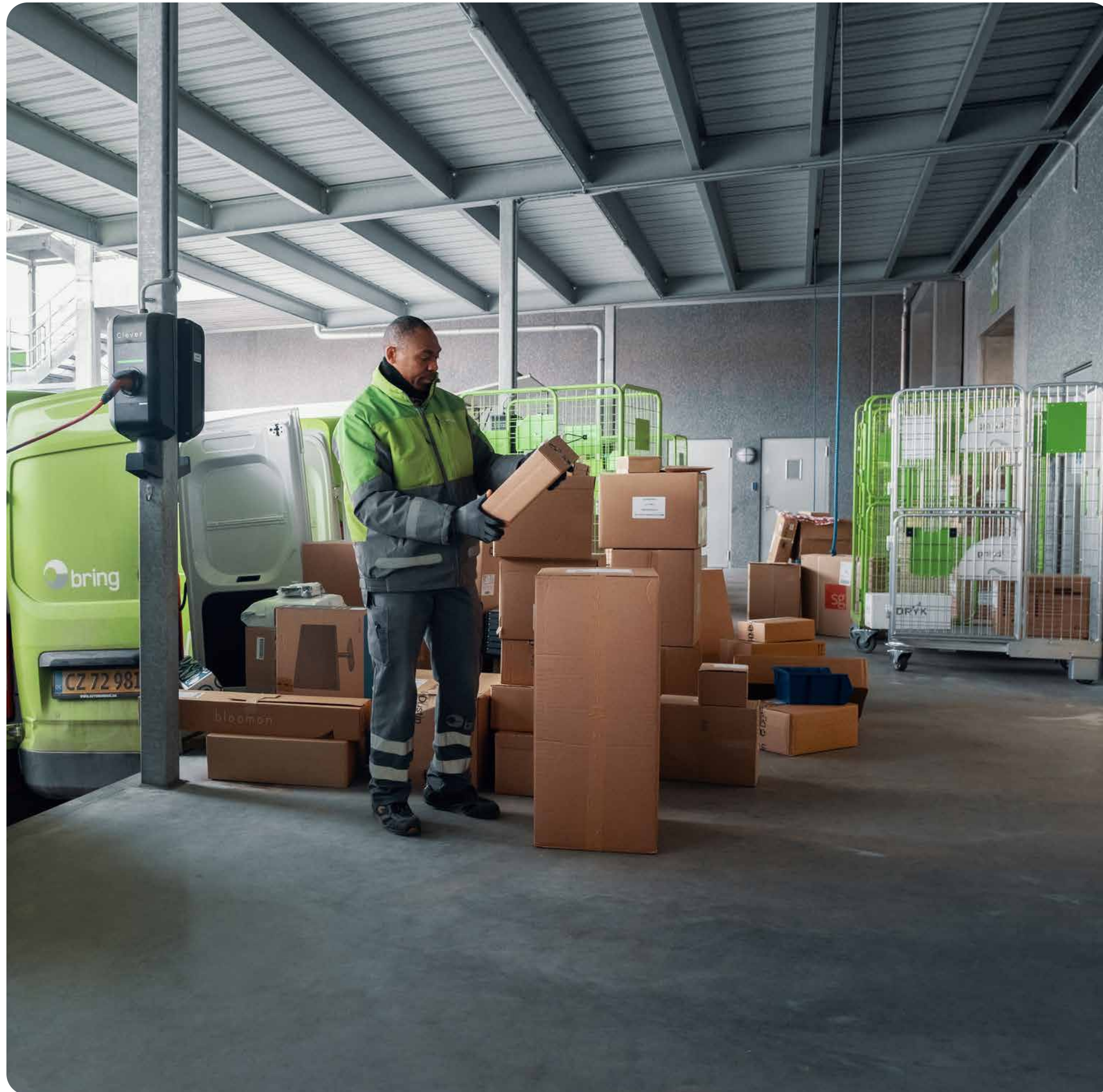

with other consignments. Requirements of the nature of the consignment, e.g. packaging and labelling. There are also requirements concerning EDI-messages. This is described in this document, and the terms and conditions are in accordance with the applicable framework conditions at any time.

1.5.1 Additional costs

Bring reserves the right to charge the customer for any extraordinary costs beyond Bring's control, as from the date on which the costs are incurred.

Examples of such costs might be (but are not limited to) rerouting as a consequence of roadworks, ferry disruptions, train disruptions, force majeure or similar circumstances requiring changes to our normal production. Force majeure events that make alternative carriage impossible are exempt, and the additional costs will therefore have an impact when events require alternative carriage solutions that are feasible without extraordinary measures, and beyond the date of the incident.

1.5.2 Surcharges

If Posten and Bring's terms and conditions are not fulfilled, the customer will be charged for the additional work/additional costs this entails for Posten and Bring. See section 3.4.6 Surcharges and bring.no.

1.5.3 Parcel handling surcharges

There may be parcel handling surcharges if one or more of the following criteria arise:

- Consignments that exceed the following dimensions 120 x 60 x 60 cm.
This also applies to Business parcel express
- The parcel is below the minimum dimensions (23 x 13 x 1 cm)
- The parcel is in rolled form
- Consignments that have inadequate packaging
- Cannot be produced by machine for other reasons

See section 3.4.6 Surcharges.

1.5.4 Errors or missing EDI

To be able to undertake transport in accordance with applicable timetables Bring depends on all consignments being notified in advance. We require advance notification via EDI, which must include full and correct information.

Examples are the pick-up and delivery addresses and details of the actual consignment. There will be a surcharge for consignments for which no EDI-information has been received as agreed, or if the information provided is incorrect. See section 3.4.6 Surcharges.

1.5.5. Delayed EDI-message

There will be a surcharge for consignments for which no EDI-information has been received

as agreed, so that Bring has to request this information. See section 3.4.6 Surcharges.

1.5.6 Storage of consignments without EDI received

If no EDI-message has been received as agreed and the consignments have to be stored pending EDI, a storage lease charge will be incurred. See section 3.4.6 Surcharges.

1.5.7 Inadequate packaging

Consignments that, due to faulty or incorrect packaging, are repaired or need to be repackaged, will be subject to a surcharge per consignment. See section 3.4.6 Surcharges.

1.5.8 Work according to agreement

Work performed for the customer according to agreement. Price per hour and 15 minute-period or part thereof.

Consignments heavier than the permitted weight or with an invalid transport label.

Packages which exceed the permitted weight and consignments that are marked with other carriers' labels entail additional work for Bring. Bring contacts the sender to agree on whether the consignment is to be returned or converted and forwarded. Price per package/consignment. See section 3.4.6 Surcharges.

1.5.9 Manual invoice

Preparation of manual invoices. Price per item See section 3.4.6 Surcharges.

1.5.10 Consignment number

Use of an incorrect consignment number, or reuse of a consignment number, is subject to a surcharge per consignment with an incorrect consignment number. Bring creates a new consignment number. See section 3.4.6 Surcharges.

1.5.11 Customer number

Use of an incorrect customer number where the customer is to be credited is subject to a surcharge. See section 3.4.6 Surcharges.

1.6 Liability and insurance

1.6.1 The customer's liability

The customer must accept its part of the liability defined in Bring's terms and conditions. If the customer fails to fulfil a significant part of its obligations, or it is apparent from the customer's actions or other serious failure in creditworthiness that the customer will not fulfil a significant part of its obligations, Bring may suspend its fulfilment and withhold performance of its services, provided that the customer is notified of this without undue delay. If a party is in material breach of its obligations under the agreement and



does not remedy the obligation after prior written notice from the other party, the agreement may be terminated by the party that is not in breach.

1.6.2 Bring's indemnification liability

Bring has a limited indemnification liability in accordance with applicable NSAB, The Norwegian Road Carriage Contracts Act, The Norwegian Civil Aviation Act, The Norwegian Maritime Code. The carrier's compensation liability is limited to the maximum:

Domestic vehicle/Rail transport: SDR* 17) per kg gross weight. **Domestic sea:** 17 SDR*) or **cross-border sea transport:** SDR* 2) per kg gross weight/SDR* 667 per package. **Cross-border vehicle/Rail transport:** SDR* 8.33) per kg gross weight. **Air freight:** SDR* 26) per kg gross weight.

The carrier's liability in the event of delay is limited to the maximum freight amount.

**SDR are supplementary foreign exchange reserve assets defined and maintained by the International Monetary Found (IMF) and used in international law.*

1.6.3 Compensation Business parcel express

In the event of delays due to Posten and Bring the freight amount will be refunded. A freight reimbursement claim must be submitted no later than two weeks after delivery. Business parcel

express is insured against loss and damage for up to NOK 50.000,- and consequential damage for an added up to NOK 50.000,-.

In the event of loss, it is the sender who must file a claim for compensation and document the value of the shipment, while in the case of damage, it is the recipient who must file a claim for compensation and document the value of the shipment.

If the shipment is not properly packaged and this could contribute to loss or damaged content, the claim for compensation may be rejected.

Relevant documentation could include a copy of the receipt from the purchase of the item/content in the package, a photo of the package packaging, or a description of any markings/logo that can help identify the package.

In the case of damage: a photo of the damaged item/content and the inner/outer packaging. Compensation will not be paid out if the documentation is incomplete or incorrect. The content/packaging must be preserved until the case is resolved.

If there are circumstances that give reason to suspect that an alleged loss is not genuine, the claim for compensation may be denied. Such circumstances could include the sender

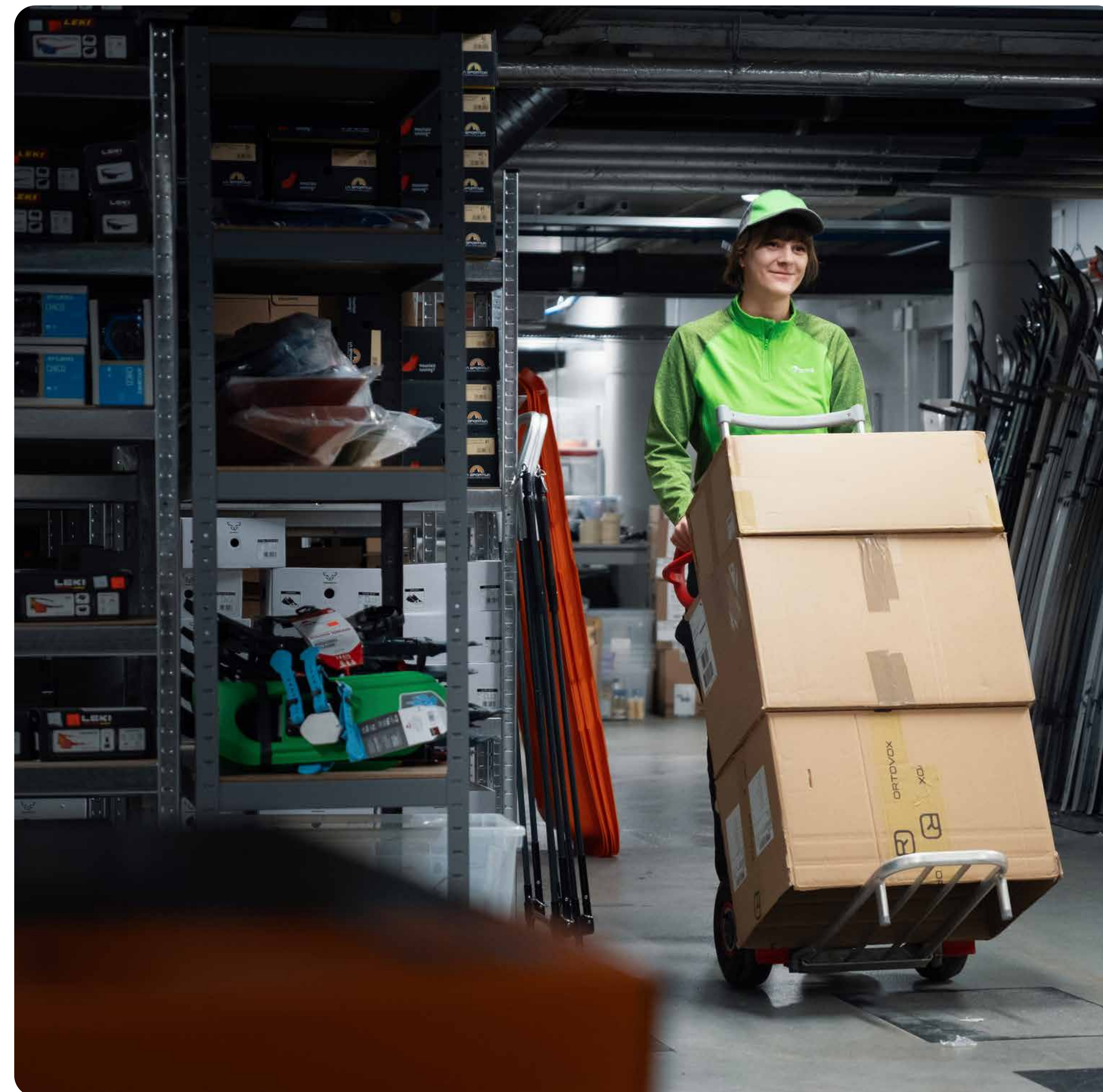

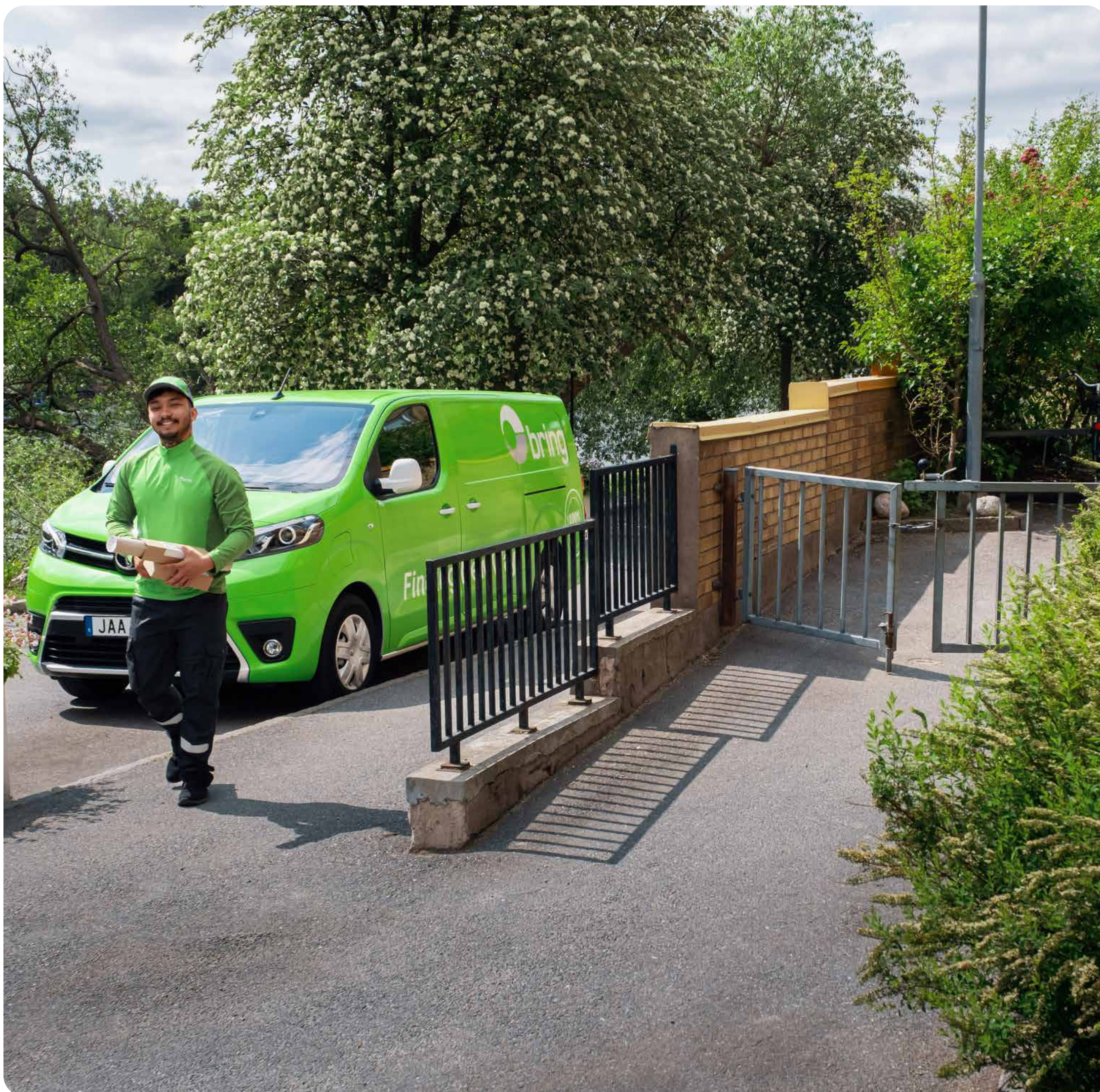

previously making repeated claims to an extent and of a nature that deviates from what is otherwise normal, or presenting forged documentation. Attempts at fraud or other fraudulent activities may be reported to the police.

1.6.4 Posten Bring's load cages

If the customer uses wire cages belonging to Posten Bring AS for the loading and delivery of parcels, the customer may be charged NOK 5,000 if these cages are damaged or lost while they are in the customer's custody.

1.6.5 Insurance

Purchase of transport does not include insurance unless specifically agreed for the individual consignment. Concerning the purchase of insurance, see section 1.2.7 Insurance.

1.6.6 Delivery times

Our delivery schedules state indicative delivery times. The delivery times can be found in Mybring. Services with a time guarantee are Business parcel express.

1.7 Other transport terms

1.7.1 Safety provisions

Carriage of parcels is subject to public safety

provisions. The sender is obliged to ensure that the contents of the consignment are properly packed and labelled, and that forwarding is permitted in accordance with the applicable safety requirements for the transport in question. Parcels for consignment as air freight for parts of the route must be subject to safety inspection. This may entail that the consignment has to be opened by the safety inspector, for further investigation. The safety inspection is performed by an authorised third party, as instructed by the aviation authorities. Posten and Bring are obliged to comply with the applicable transport and safety regulations at any time, and are not liable for delays or for consequential damage due to the nature of the consignment or to circumstances beyond Posten and Bring's control.

Where the aforementioned conditions include Business parcel express parcels, the consignment may be returned to the sender, stopped pending collection by the sender, or moved from air transport to land transport (vehicle/rail), if this is an appropriate method of carriage. Bring reserves the right to make these assessments, particularly for consignments to be transported by air – where these are inspected by an external safety operator approved by the Norwegian Civil Aviation Authority.

For more information about air freight, see bring.no. Posten and Bring are obliged to comply with the applicable transport and safety regulations

at any time, and are not liable for delays or for consequential damage due to circumstances related to the nature of the consignment or to circumstances beyond Norway Post's and Bring's control.

1.7.2 Parcels may not contain

Parcels sent with Bring may only contain limited quantities of dangerous goods, in accordance with ADR. For Business parcel express, the parcels may not even contain limited quantities. For more details, see www.bring.no

The customer is responsible for ensuring that the goods can be legally transported in accordance with international conventions or the legislation in the country to, from and within which the goods are carried. Bring does not carry goods that are not permitted to be sold or distributed in Norway. For other regulations concerning dangerous goods, see section 2. Groupage and partloads, section 2.2.2 Dangerous goods.

1.7.3 Calculation of weight and volume

The consignment's total dimensions and weight, including packaging, are the basis for price calculation. Bring reserves the right to make correction to the right weight and dimensions as the basis for calculating the price of the services. Freight calculation is determined by the freight calculation weight, which is the higher of the weight by volume and the actual weight. The maximum length, breadth and height of the

consignment determine the volume. A fixed factor for conversion of volume to weight is defined for our parcel services.

By using this conversion you will find the weight by volume: $L(\text{dm}) \times B(\text{dm}) \times H(\text{dm}) / \text{conversion factor}$. The freight is always calculated according to the calculation method that gives the highest calculation weight.

1.7.4 Freight calculation

The freight charge is calculated separately for each package. A consignment refers to the packages stated by a consignment number or consignment note for carriage from a sender to a recipient. A consignment may consist of one or more packages. All packages in a consignment must be delivered to Bring on the same day.

As a general rule, all costs must be paid by the sender, who must have an approved credit and customer number.

1.7.5 EDI and labelling

Correct labelling and the correct EDI-message will ensure that all consignments are handled correctly. In addition to clear and correct labelling, cf. Bring's applicable specifications, the labelling must be in accordance with the EDI-message. Only labels approved by Bring are accepted, preferably the Norwegian EDIPRO standard. Depending on the content, the bar code must be symbology GS1-128 in accordance with



the EAN/UCC standard, Code 128 in accordance with EN 799, X-module minimum 0.375 mm, height minimum 27 mm.

Readability must be satisfactory according to CEN standard EN1635. Quality minimum ANSI B.

For the labels to be legible at all stages of the logistics chain, it is important to be aware of the following:

- An EDI-message must be sent to Bring before the relevant consignments are picked up or delivered to Bring/Bring's partner
- Labels must be clearly visible on all packages
- Labels may not be folded around a corner
- Labels should not be coated with plastic foil, unless the foil is smooth against the label
- There must be no straps across barcodes on labels
- To ensure legibility, the label must be smooth
- Some of our services require special labelling
- Labels must be placed on the natural upside of the package, if the weight is below 35 kg
- Barcode character A-B

Our IT solutions fulfil all the norms and requirements set out in the common system for the identification of goods of 1 July 2000 issued by the Norstella Foundation and EAN Norway. The solution communicates with most EDI-system suppliers.

Consignments that do not fulfil the requirements may be rejected, delayed or subject to an additional charge. Error messages or errors in EDI-messages are corrected by Bring. Invoicing for errors will be charged to the freight payer in accordance with the applicable prices. See part 3, section 3.4.6 Surcharges.

1.7.6 Packaging

The sender is responsible to ensure that the content of a consignment is packaged or/and packed responsibly. The packaging must be adapted to the goods and in such a way that the goods can be safely transported.

Fragile goods must be wrapped in impactabsorbing material to absorb pressure and impact while protecting the content. The nature of the packaging must be in such a way that the items can be loaded safely together with other consignments.

Please note that:

- The goods original packaging is not valid for transportation
- Bring is not liable to compensate for occurring damages due to either high or low temperatures. If the consignment contains goods that cannot handle frost it is required book the service Business groupage with the added service Frost-free.
- Goods such as engines must be emptied of liquid content before shipping.





- Consignments on pallets must be wrapped, strapped or packaged in such a way to ensure the best possible protection from damage and so that the goods remain intact on the pallet during the entire transportation.

Inadequate packaging and correction will be invoiced and charged to the freight payer in accordance with the applicable prices.

1.7.7 Payment terms

For customers without an invoice/credit agreement, the freight must be paid in advance. All submitted assignments can be invoiced. It is possible to order transport of both parcels and goods at www.mybring.no and to pay by card.

1.7.8 Credit

By further agreement, up to 10 days' credit and an agreed credit limit are normally granted. Credit and the credit limit will lapse on any form of payment default. In the event of late payment, late payment interest will accrue in accordance with the Norwegian Act relating to Interest on Overdue Payments. Posten and Bring calculate reminder fees for reminders and debt collection notifications in accordance with standard legislative provisions, at 1/10 of the applicable legal fees.

All new customers will be credit assessed by Posten and Bring, and a copy letter stating that this has taken place will be sent to the customer.

1.7.9 Invoice

All assignments for which credit has been granted must be paid according to invoice and must be received by Bring by the due date. Any objections to an invoice must have been raised in writing to Bring within 8 days of receipt of the invoice. In the event of payment default, invoices not yet due are also considered to have fallen due and can be recovered together with overdue claims.

Posten and Bring are entitled to set off their outstanding amounts against claims held by the customer against Posten and Bring. The customer may not set off or withhold any money that has fallen due even if freight, damage or loss is claimed.

If the agreed credit limit has been exceeded, or in the event of payment default or downgrading of creditworthiness, Posten and Bring may stop the customer's consignments by taking a lien on the customer's goods. In cases where creditworthiness is downgraded, the customer may be offered a new credit agreement against security. Posten and Bring will determine the security amount. Copies of invoices with specifications are available to our customers in Mybring.

Copies of consignment notes or other underlying documents can be obtained upon request or by agreement.

1.7.10 Reminder fees

Bring is entitled to set off/retain money that has fallen due even if freight, damage or loss has been claimed. The reminder fee adheres to the Norwegian Debt Collection Act and the applicable rates at any time. The standard procedure for reminders/collection is used for unpaid invoices. The reminder fee is stipulated by law and is always 1/10 of the applicable collection rate.

The collection rate is subject to annual adjustment by the Norwegian Ministry of Justice. Priced per invoice.

1.7.11 Fuel surcharge

As a variable price element, we add a fuel surcharge for parcels. The surcharge is updated on a monthly basis and the applicable surcharge can be found at bring.no.

1.7.12 Toll charges

Consignments will be subject to a variable surcharge to cover the toll costs. Information about this can be found at bring.no

1.7.13 Surcharge for incorrectly addressed parcels

Incorrect delivery address means the use of postcodes for postboxes or invalid postcodes. See part 3, section 3.4.6 Surcharges.

1.7.14 Goods in transit

The customs authorities require information about the freight's contents (goods type) to be stated at the border crossing (transit). Bring complies with the requirements imposed by the customs authorities, and requires the customer/sender to provide information about this in the EDI-message. Examples of approved goods types may be: office supplies, groceries or industrial goods, or more specific goods types such as clothing, paper, etc. Without exception, field 35 of the EDI-message must contain the aforementioned. It is the customer's responsibility to provide Bring with the necessary information. Bring is exempt from any liability in the event of delays due to lack of information.

1.8 Claims and Compensation

Bring's indemnification liability is limited to the applicable NSAB, the Norwegian Road Carriage Contracts Act, the Norwegian Civil Aviation Act and the Norwegian Maritime Code in force at any given time. Damage/losses/deficiencies on delivery must be noted on the consignment note on delivery to both the driver and the recipient. In the case of consignments without a consignment note, the corresponding information must be noted on and registered in the driver's handheld terminal. If the damage is not externally visible, the recipient must notify Bring's Customer

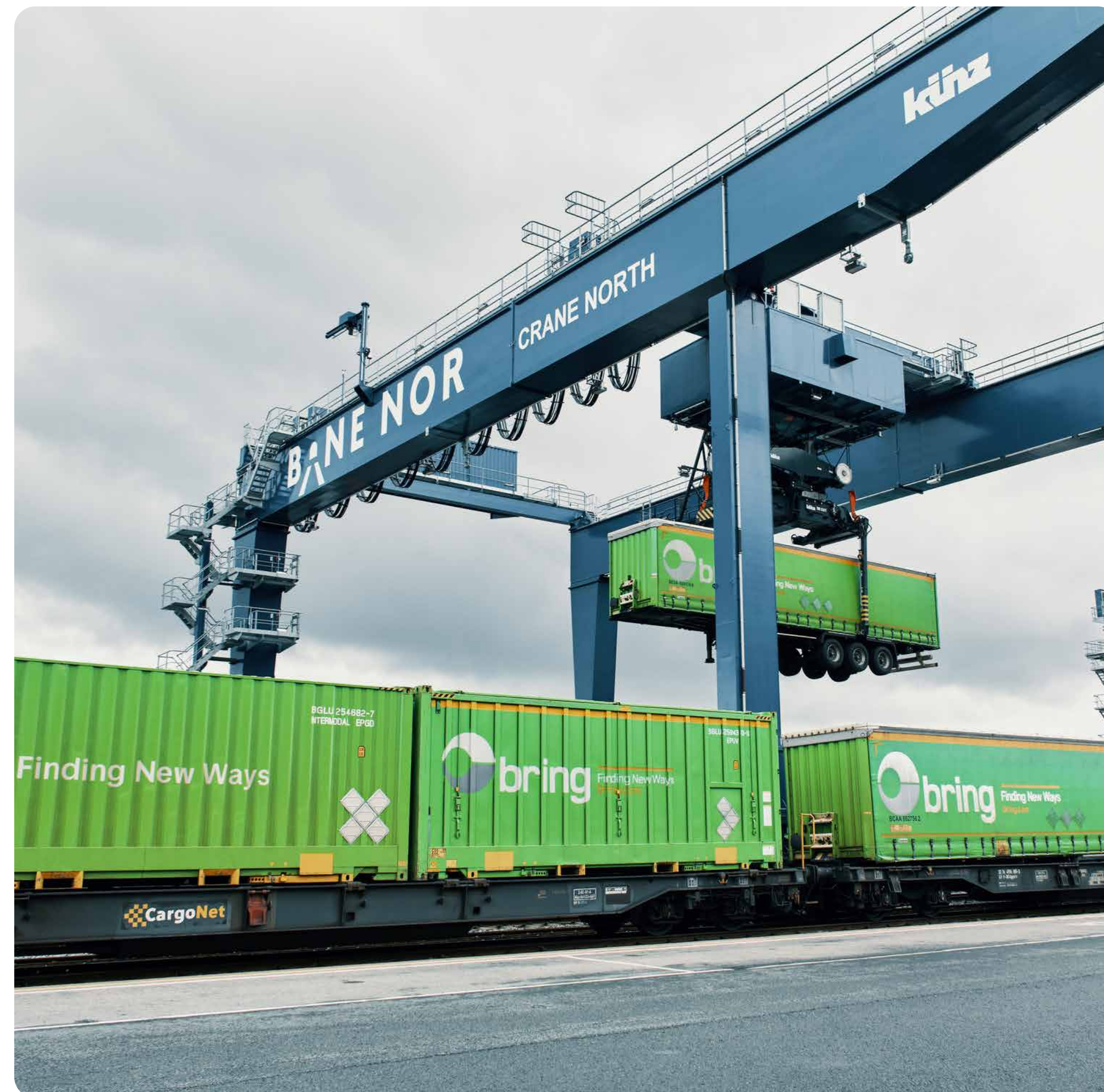

Service (Claims Department) in writing without undue delay.

Please note that it is the recipient's responsibility to check the goods before they are signed off as received. If a receipt has been given on the transport document, or the customer has noted the name on the display in the handheld terminal without any comments, it must be assumed that at the time of delivery the goods were in the condition specified on the transport document.

An invoice may not be issued to Posten Bring AS or Bring in claims cases, but a written claim must be submitted via Mybring. The following documentation is required:

Information: Consignment number and a brief description of the course of events.

Documentation: A copy of the commercial invoice, documentation of the goods' impairment, actual weight of the damaged goods and pictures showing what has been damaged and the relevant items/object(s)/goods. Clear pictures of the damaged goods and their packaging must be attached. In the event of major extensive damage, the goods must be stored safely so that they can be inspected by the appraiser/insurance company for assessment. The goods must be protected from further damage/loss.

Goods and packaging for which claims have been made must be stored until the matter has been fully processed. Claims must be submitted by the freight payer (the party that paid the freight to Bring). For services with time guarantees, special conditions are specified in the service specification. The period of limitation is one year from delivery of the goods

The carrier's compensation liability is limited to the maximum:

Bring has a limited indemnification liability in accordance with applicable NSAB, The Norwegian Road Carriage Contracts Act, The Norwegian Civil Aviation Act, The Norwegian Maritime Code.'

Domestic vehicle/Rail transport: SDR* 17) per kg gross weight. **Domestic sea:** 17 SDR*) or **cross-border sea transport:** SDR* 2) per kg gross weight/SDR* 667 per package. **Cross-border vehicle/Rail transport:** SDR* 8.33) per kg gross weight. **Air freight:** SDR* 26) per kg gross weight.

The carrier's liability in the event of delay is limited to the maximum freight amount.

Liability is otherwise regulated in accordance with the legislation in force at any given time. For forwarding assignments, liability is regulated in accordance with NSAB 2015 (Nordic Forwarder Federation's General Provisions, except Section

27c, storage), the CMR Convention, the Hague-Visby Convention and the Warsaw Convention.

**SDR are supplementary foreign exchange reserve assets defined and maintained by the International Monetary Fund (IMF) and used in international law.*

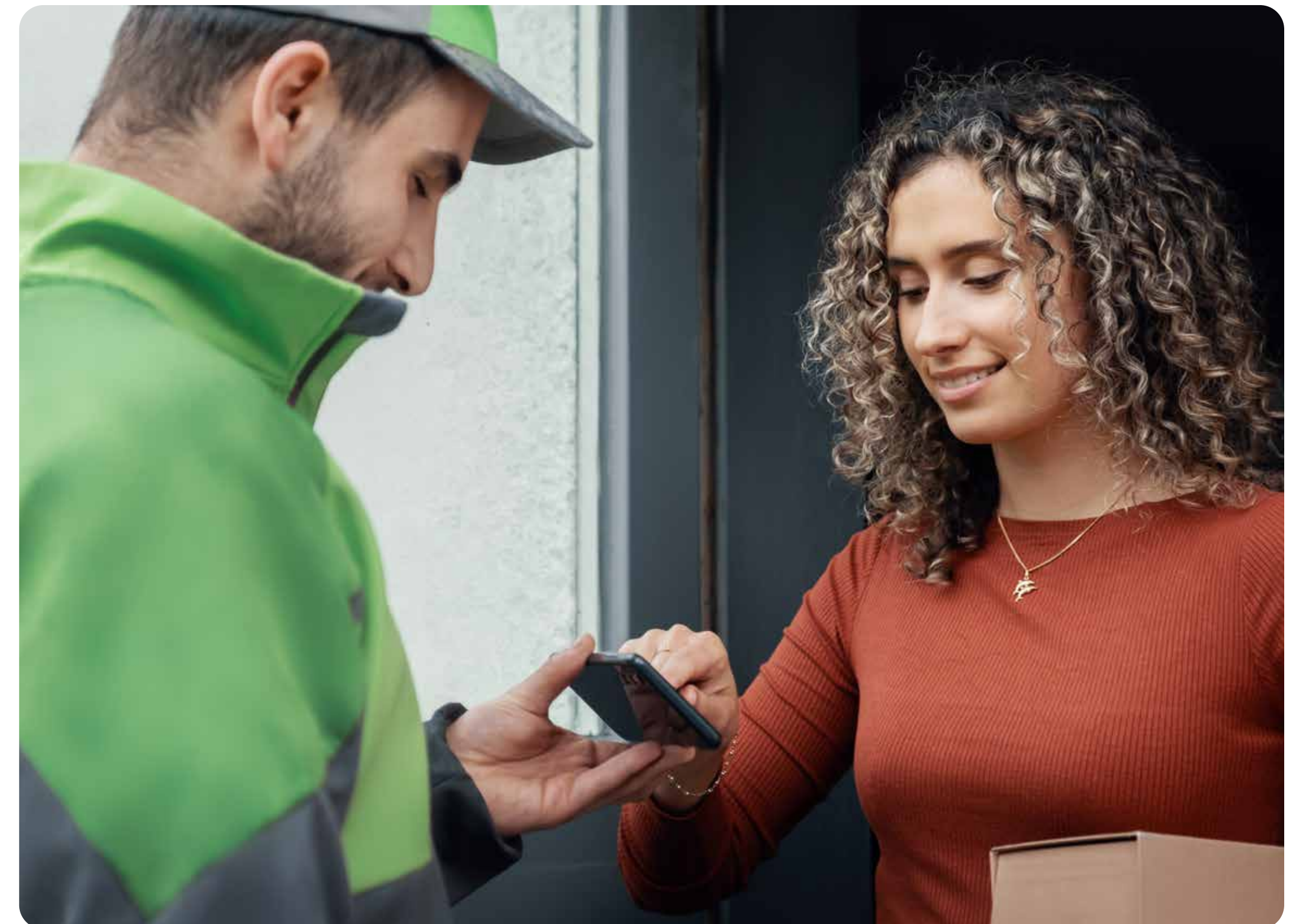

Part 2 Before 7, Business groupage and Business partloads

OUR SERVICE

- 2.1 Services pp. 22-23
- 2.2 Additional services – Surcharge pp. 23-26
- 2.3 Additional information on services pp. 26-27
- 2.4 Collection and delivery pp. 27-29

CONDITIONS FOR TRANSPORT

- 2.5 Conditions for transport of groupage and partloads pp. 29-31
- 2.6 Weight and volume calculation pp. 31-32
- 2.7 Liability and insurance pp. 32-33
- 2.8 Payment terms pp. 34-35
- 2.9 Claims and compensation pp. 35-36
- 2.10 Special provisions pp. 36-39



2.1 Services

Do you need customised collection or extra early delivery? Bring offers a range of services that meet our customers' logistics needs.

2.1.1 Business groupage

- Consignments weighing 1-9999 kg between businesses door-to-door
- We use our nationwide network with modern terminals
- Collected and delivered between: 08:00 and 16:00

2.1.2 Business pallet

A groupage service for customers sending goods packed and plastic-wrapped on standard EUR pallets.

- Collected and delivered between: 08:00 and 16:00
- The goods must be plastered on a standard pallet 80 x 120 cm, and maximum height is 2.20 m
- Max weight 800 kg per pallet
- Up to 12 pallets per shipment
- Exceeds the dimensions or weight of the properties for the service is calculated an additional +50% of the pallet price of the pallet(s) in question large (oversized pallet)

- We use our nationwide network with modern terminals

2.1.3 Business partload

- Consignments with freight-calculated weight from 3,500 kg per consignment
- Door-to-door direct transport
- Dialogue with carrier via pre-booking

2.1.4 Before 7 for businesses

- Overnight consignments delivered to the recipient before 07:00
- Requires a separate agreement
- Applies to delivery from/to defined addresses
- Delivery in accordance with delivery instructions
- Maximum weight per package 400 kg
- Maximum weight per consignment 2,500 kg
- Maximum length 2.4 metres
- Packages below 35 kg may measure up to 6 metres

Before 7 is delivered at night without the recipient's signature, which entails the following rules concerning any claims: If there is damage to a before 7 consignment that is not visible to the driver, the recipient must notify this as soon as possible and at the latest within four hours.



calculated from the recipient's opening hours. The damage must be documented with a picture, etc. and reported to the sender, who in turn will report this to Bring without undue delay. There is no time guarantee for the Before 7 service.

2.1.5 Return of Business groupage

Only applies if the original consignment was sent with Bring, and all or part of the delivery is to be returned. Pick-up from the original recipient's address. Small consignments are picked up at an outer door and larger consignments are picked up at a ramp/ground level. A simple scheme whereby your business pays the return freight charge. The service is ordered as a separate consignment, and if you wish, Bring can label the goods for you. We then use the label from the sender. Pick-up the next day at the earliest. This service cannot be used for special goods.

2.1.6 E-services

Transport with Bring entails access to a number of e-services. In addition to integration directly with our IT system, we offer our customers Mybring, an online self-service solution that gives you full control of your deliveries with Bring, wherever you are located. With a single sign-on, you can easily generate customised reports and order parcel, freight and courier shipments. Now also with GPS coordinates for all services. Mybring is available 24 hours a day, and is free of charge for Bring customers.

Our IT solutions comply with all the standards and requirements set out in the common system for the identification of freight of 1 July 2000 issued by the Norstella Foundation and EAN Norway. The solution communicates with most EDI-system suppliers.

Consignments that do not fulfil the requirements may be rejected, delayed or subject to an additional charge. Error messages or errors in EDI-messages are corrected by Bring. Invoicing for errors will be charged to the freight payer in accordance with the applicable prices.

2.2 Additional Services Groupage and Partloads

Bring offers additional services that add value for customers. Some of these services are listed below. Other additional services are shown in the price lists at bring.no.

2.2.1 Special goods

Consignments:

- Where one of the packages weighs more than 1,200 kg or has a long side measuring 2.4 m or more
- Has two sides each measuring 2 m or more
- No fixed delivery time
- Requires a separate agreement



- Surcharge, see section 3.5.5 Surcharges
- Valid for Business groupage, Business pallets and Business partload

2.2.2 Dangerous goods (ADR):

- Consignments that are defined as ADR loads. See section 2.10
- Separate regulations and responsibility for the sender (customer) and carrier must be adhered to. See further terms in 2.10
- Own documents and own labelling
- Surcharge, see section 3.4.5
- Valid for Business groupage and Business partload

2.2.3 Frost-free:

- Customers can order a frost-free service for an additional fee. The service does not come with a temperature guarantee. Yet, we strive to ensure that the carrier keeps the shipment frost-free at a temperature above 0 degrees Celsius.
- This service is available during the winter season from October to March.
- To ensure correct equipment, the operational arrangement is somewhat limited and a longer delivery time must be expected.
- Requires separate booking and labelling of all packages.
- Surcharge, see section 3.4.5
- Valid for Business groupage, Business pallets and Business partload.

2.2.4 Simplified delivery

A service whereby the sender permits Bring to leave the goods at the recipient's location without the recipient being present to receive the delivery. The service must be ordered via EDI-message. According to the agreement with the sender, the driver leaves the goods at street level, and the driver registers that the goods have been delivered, thereby ensuring the traceability of the consignment. Bring sends a text message on delivery. This service entails that the customer accepts the associated risk with regard to liability and surrenders the right to compensation in the event of damage and loss. Not all addresses in Norway are suitable for leaving goods in this way, which the sender must take into consideration.

Simplified delivery is not recommended in large cities or for apartment blocks unless Bring is able to deliver the goods in an enclosed entrance or similar. The value of the goods should also be taken into consideration.

This service is not appropriate for readily marketable goods that can easily be removed.

2.2.5 Project

We offer transport and logistics solutions adapted to a project that is limited in time or volume. Priced according to agreement.

2.2.6 Deployment of expertise

In cooperation with our customers, we analyse





possible areas in which we can improve the customer's logistics efficiency through extended cooperation.

Bring currently offers dedicated personnel with training and experience in the logistics area who, together with our customers, can analyse and identify measures to improve the customer's logistics efficiency. Priced per hour.

2.2.7 Agreed Delivery Notification

The service has to be ordered via EDI. The service is to be invoiced to the freight payer in accordance with the applicable prices.

Bring will contact the recipient when the goods are arrived at the last mile terminal to make an agreement on the delivery. The agreement is made between the last mile terminal and the recipient. The agreement can deviate from standard delivery time and is not included in the standard KPIs for deliveries. In addition the driver will contact the recipient approximately 30-60 minutes before the delivery is to be delivered. The service requires that the EDI contains the correct recipient information. When booking the service a mobile number for the recipient is required. Storage fee will be invoiced the freight payer as of the 3rd business day if the delivery time is agreed in the future. (Beyond the city center perimeter the storage fee will be invoiced as of the 5th business day.)

Bring will attempt to contact the recipient 3 times to make a delivery agreement. If Bring is unsuccessful to make contact with the recipient after 7 days the goods will be sent in return to the sender.

Agreed delivery notification with recipient can also be performed and will be invoiced the freight payer if the following applies:- Unattended address, e.g. sole proprietorship,

- construction site, farm or similar places without permanent staff or a staffed reception between the working hours 08:00-16:00
- Consignments where Bring is required to achieve contact for further agreement with the recipient or the recipient contacts Bring to avoid attempted deliveries or missing deliveries.

2.2.8 Warehouse rental

If contact with the recipient is not achieved, it must be sought to contact the recipient again on day 2 after the goods have arrived at the distribution terminal. If the consignment has not been picked up or delivered within two business days of the notification being given, warehouse rental will accrue as from and including day 3. See section 3.4.6 Surcharges.

2.2.9 Exchange of EUR pallets

Is not offered.

2.3 Additional information services

2.3.1 Returned consignments

Consignments that we cannot deliver to the recipient will be returned for the customer's account.

2.3.2 Delivery precision and calculation of delivery time

We have an indicative delivery time for our services, unless otherwise stated as terms and conditions for the individual service. The delivery time applies from the registration of the consignment's arrival at our sender terminal until it is delivered to/made available to the recipient, and the delivery time is measured as full days. This is subject to the condition that correct data has been received by Bring in accordance with the terms and conditions for the relevant service and that all packages are properly packaged and labelled. Delivery takes place Monday-Friday, normally between 08:00-16:00.

Exceptions:

- Weekends and public holidays, as well as Christmas, Easter and summer holiday periods
- Groupage deliveries to private individuals or to businesses when the consignment must be notified
- Force majeure such as floods, landslides,

snowfalls or other reduced accessibility of road or rail services

2.3.3 Consignments to Svalbard and Spitsbergen

Goods are consigned by ship. Bring uses M/S "Norbjørn" for transport of groupage and partloads. M/S "Norbjørn" has a high ice classification, a 70-tonne lifting crane, large hatches and good hold and deck capacity. In addition, the boat has freezer capacity, and heating and cooling in containers. Large partloads can be coordinated or shipped directly from other ports in Norway.

Groupage and partloads must always be subject to customs clearance. Goods for Svalbard are relabelled at Bring in Tromsø, and a commercial invoice (possibly a pro forma invoice) must accompany the consignment. The Norwegian Maritime Code applies to sea transport. This entails separate rules for insurance of freight consignments to Svalbard.

We have a long tradition and experience from handling consignments to and from Svalbard, and have gathered our expertise in Tromsø. Svalbard is regarded as a third country in customs terms, so that advance notification and customs clearance are required. Inadequate documentation might result in delays and additional costs. For consignments to Svalbard and Spitsbergen there is a surcharge for all services. Our branch in

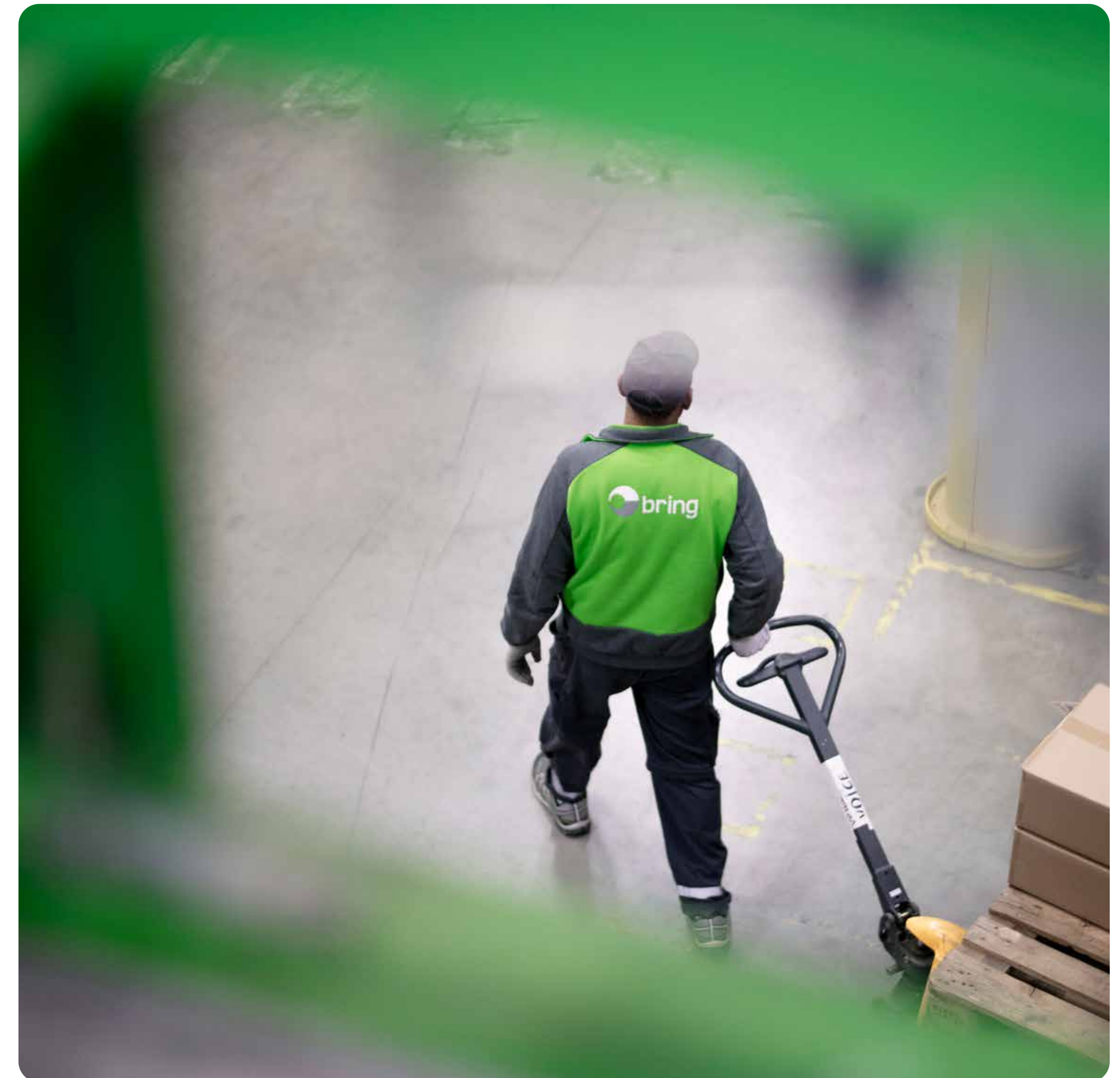

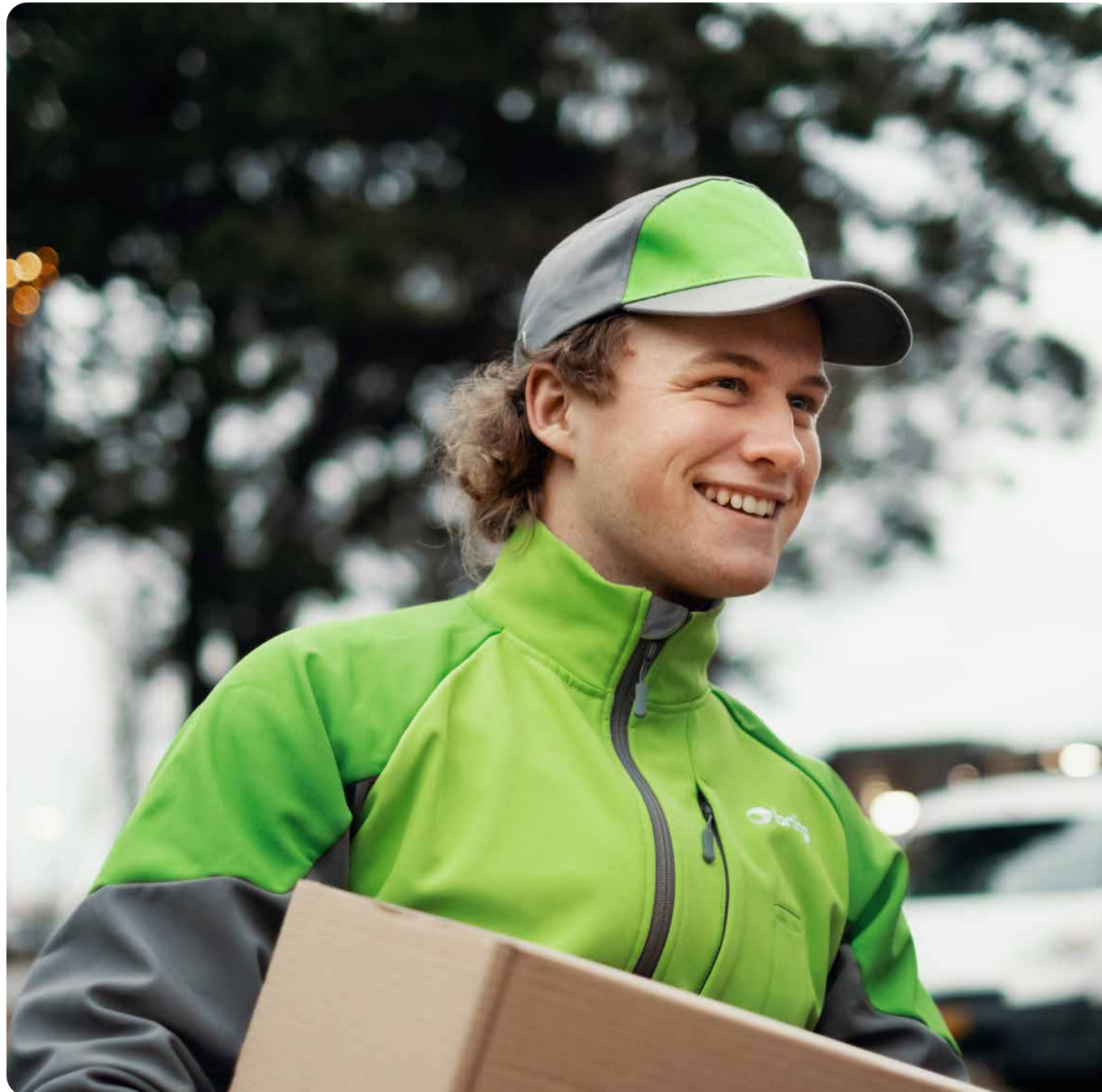

Tromsø can answer any questions about transport to Svalbard. For further information and prices, please contact us at tromso.support@bring.com.

2.4 Collection and Delivery

2.4.1 Collection and delivery of Business groupage, Business pallet, Before7 for business, Return of business groupage

If the freight amount exceeds NOK 450 per service on the same day and from the same address, collection is included in the freight price. This requires the use of a customer number and collection on the same date. For collection of freight below this amount, a surcharge for small collection will be added to the freight charge. See section 3.5.5 Surcharges.

The following is offered:

- Collection on fixed days at fixed times with agreed volume
- Collection after pre-booking

A consignment may consist of one or more packages. All packages in a consignment must be delivered to Bring at the same time.

Shipments are considered as collected when they are scanned as handed in at the customer or terminals.

The booking deadline for collection of groupage on the same day is normally before 11:30 from locations close to our terminals. Separate local collection deadlines apply to the Before7 and return services. If you have a collection address outside the local area, you must expect collection on the next working day, or possibly further into the future.

Delivery according to a transport schedule/delivery times.

Delivery to addresses outside the normal route may entail a longer delivery time and/or extra costs.

2.4.2 Goods are collected and delivered at street or ramp level.

It is assumed that the conditions provide for collection and delivery to take place using ordinary distribution equipment. Up to 18-pallet vehicle with tail lift.

Delivery and collection at special times, to and from businesses with addresses in shopping malls, and indoors in shops, restaurants, newsagents, etc. take place at the agreed time and place. Delivery normally takes place Monday to Friday before 16:00.

2.4.3 Business partload

It must be possible for partloads to be carried directly from the sender to the recipient without reloading. The minimum weight for partloads is



3,500 kg freight-chargeable weight (10.5 m³). Partloads must be prebooked with and confirmed by the carrier in order for the assignment to be accepted by Bring. Detailed consignment information must normally be transmitted electronically via EDI.

Consignments exceeding 3,500 kg that are not prebooked and confirmed by the carrier will be priced and carried in accordance with the ordinary terms and conditions for groupage.

If it is not possible to carry out the transport using Bring's setup equipment, extra costs will be charged to the paying customer. This might be conditions at the sender's or recipient's location, or the need for a tail lift, crane, open roof or any other equipment that was not assumed when the assignment was accepted.

The booking deadline for partloads is 14:30 on the day before the consignment is to be loaded, unless otherwise agreed. Delivery of partloads normally takes place between 08:00 and 16:00 on business days. Unless otherwise agreed, extra delivery time may be calculated compared to the current delivery plan for groupage.

2.4.4 Empty pick-up and several delivery attempts

In cases where the recipient refuses to receive the goods, or there is an impediment to delivery, Bring obtains a conditional order from the

customer. If no conditional order has been received within 7 days of the date of issue, the consignment is automatically returned for the account and risk of the customer. Two delivery attempts are made. If two delivery attempts are made, a surcharge will apply.

2.4.5 Limitations and impediments concerning transport

Some postcodes may have limited options for collection and delivery, even within the same postcode. Examples might be:

- Local barriers
- Summer cabin areas
- Islands with limited ferry services
- Other geographical areas where Bring does not have normal driving routes, e.g. mountain areas or other areas subject to seasonal restrictions

Bring reserves the right to charge the freight payer for freight surcharges in such cases. Where additional costs may accrue, as far as possible this will be notified before the actual pick-up or delivery takes place. Any additional costs will be invoiced to the customer. Senders and recipients with addresses in such areas must expect deviations in delivery times. Where accessibility is greatly reduced, or requires special equipment, the pickup or delivery address may differ from the actual address. Examples could be delivery at the ferry quay on the land side.

For consignments of special goods, the use of extraordinary equipment (e.g. mobile cranes) might affect the extent of the aforementioned. For dangerous goods consignments, deviations may occur due to requirements for the carriage of dangerous goods.

For frost-free consignments, we will normally have a separate scheme for this in the winter season (October-March).

Bring reserves the right to invoice the customer for unreasonable amounts of time spent and/or waiting time during loading or unloading.

2.5 Conditions for Groupage and Partload Transport

To ensure correct handling, it is important that the conditions for using the individual service are fulfilled. Our terms and conditions can be regarded as part of the agreement for the individual transport.

Validity

Posten Bring AS distributes goods under the Bring brand name. Transport is undertaken in accordance with the tariff rates, freight calculation regulations and transport terms and conditions applicable to Bring.

Bring's transport terms and conditions are governed by the general provisions of the Nordic Forwarders Association (NSAB), the Norwegian Road Carriage Contracts Act (Act concerning road freight agreements), the Norwegian Maritime Code and our Transport Guide for parcels, groupage and partloads on a national basis. Reservation is made for changes in the framework conditions.

Bring reserves the right to make changes and modifications to these service terms and conditions with one month's notice. Subject to printing errors. Bring disclaims all liability for the customer's further use of data provided by Bring, either directly or via third parties.

2.5.1 Conditions

Approved information about each consignment whereby all packages are assumed to be scanned in accordance with agreed standards or transmitted electronically, is the agreement/transport contract for the individual consignment. Consignments will be loaded with other consignments. This imposes packaging and labelling requirements.

2.5.2 Infrastructure surcharge

Bring reserves the right to charge the customer for any extraordinary costs beyond Bring's control, as from the date on which the costs are incurred.





Examples of such costs might be (but are not limited to) rerouting as a consequence of roadworks, ferry disruptions, train disruptions or similar requiring changes to our normal production.

The exception is force majeure events that make alternative carriage impossible, and the additional costs will therefore be triggered when events require alternative carriage solutions that can be implemented without taking extraordinary measures, and beyond the day of the accident.

2.5.3 Surcharges

If Posten and Bring's terms and conditions are not fulfilled, the customer will be invoiced for the additional work/additional costs this entails for Posten and Bring. For more information, see price lists and bring.no.

2.5.4 Goods that we do not consign

Unless otherwise agreed, the goods may not include valuables, weapons, ammunition, live animals, larvae, insects or similar, remnants, removal goods, unpackaged goods, customs passport consignments or cigarettes/tobacco products.

2.5.5 Toll charges

Groupage and partload consignments will be subject to a variable surcharge to cover the toll costs. Information about this can be found at bring.no.

2.5.6 Fuel surcharge

As a variable price element, we add fuel surcharges for groupage and partloads. The surcharge is updated on a monthly basis and the applicable surcharge can always be found at bring.no.

2.5.7 Labelling

Correct labelling and correct EDI-messages ensure that all consignments are handled correctly. In addition to clear and correct labelling, cf. Bring's applicable specification, the labelling must always be in accordance with the EDI-message. Only labels approved by Bring are accepted, preferably the Norwegian EDIPRO standard.

For the labels to be legible at all stages of the logistics chain, it is important to be aware of the following

- An EDI-message must be sent to Bring before the relevant consignments are picked up or delivered to Bring/Bring's partner
- Labels must be clearly visible on all packages
- Labels may not be folded around a corner
- Labels should not be coated with plastic foil, unless the foil is smooth against the label
- There must be no straps across barcodes on labels
- To ensure legibility, the label must be smooth
- Some of our services require special labelling

2.5.8 Packaging

The sender is responsible to ensure that the content of a consignment is packaged or/and packed responsibly. The packaging must be adapted to the goods and in such a way that the goods can be safely transported.

Fragile goods must be wrapped in impact-absorbing material to absorb pressure and impact while protecting the content. The nature of the packaging must be in such a way that the items can be loaded safely together with other consignments. Consignments that can roll, have large dimensions, and a high specific weight must always be placed lying down and secured to a pallet.

Alternatively, they can be transported in another suitable load carrier. Additionally, all parcels with a nature that allows them to move must be separately secured.

Please note that:

- The goods original packaging is not valid for transportation.
- Bring is not liable to compensate for occurring damages due to either high or low temperatures. If the content is temperature sensitive, make sure to add the service for Temperature-controlled goods.
- Goods such as engines must be emptied of liquid content before shipping.
- Consignments paced on pallet must be

wrapped, strapped or packaged in such a way to ensure the best possible protection from damage and so that the goods remain intact on the pallet during the entire transportation.

Inadequate packaging and correction will be invoiced and charged to the freight payer in accordance with the applicable prices.

2.6 Calculation of weight and volume

2.6.1 Freight calculation

Freight charges are calculated separately for each consignment. A consignment refers to the packages stated by a consignment number or consignment note for carriage from a sender to a recipient. A consignment may consist of one or more packages.

All packages in a consignment must be delivered to Bring at the same time. The consignment's total weight/volume is the basis for calculating the price of the individual consignment.

The sender is responsible for the correct statement of weight and dimensions for individual consignments. Bring reserves the right to check and, in the event of errors, to correct to the



accurate weight and dimensions as the basis for calculating the price of the services. Changes may result in freight price changes, as well as a surcharge.

Freight calculation is determined by the freight calculation weight, which is the higher of the weight by volume and the actual weight. The maximum length, breadth and height of the consignment determine the volume. A fixed factor for conversion of volume to weight is defined for different services. This conversion factor can be used to find the weight by volume: $L \text{ (dm)} \times B \text{ (dm)} \times H \text{ (dm)} / \text{conversion factor}$.

For all consignments weighing more than 1,000 kg, the weight is rounded up to the nearest 100 kg. The freight is always calculated according to the calculation method that gives the highest calculation weight. See section 3.2. Conversion factors.

2.6.2 Package surcharge for Business groupage

Four packages included in standard delivery. If a groupage consignment has 5 or more packages, a surcharge of 3% of the net customer freight up to and including 8 packages, and 3.5% for 9 or more packages, will be added.

2.6.3 Special calculation rules

Load metre: For consignments that, due to their shape or the nature of the packaging, are difficult to stow and load together with other

consignments, the freight is calculated on the basis of the load space required for the goods (2,000 kg per load metre).

A load metre is 1 metre multiplied by the breadth and height of the vehicle.

Pallet space: For consignments that are loaded on pallets and that cannot be loaded together with other consignments the freight is calculated according to the number of pallet spaces that the goods take up. A pallet space is calculated according to 0.4 load metres i.e.: 800 kg. Goods strapped on europallets that can be loaded together are calculated according to a minimum of 150 kg per pallet (fixed weights).

2.7 Liability and Insurance

2.7.1 The customer's liability

The customer must accept its share of the liability defined in Bring's terms and conditions. If the customer fails to fulfil a significant part of its obligations, or it is apparent from the customer's actions or other serious failure in creditworthiness that the customer will not fulfil a significant part of its obligations,

Bring may suspend its fulfilment and withhold performance of its services, provided that the





customer is notified of this without undue delay. If a party is in material breach of its obligations under the agreement and does not remedy the obligation after prior written notice from the other party, the party in breach may not terminate the Agreement.

2.7.2 Bring's compensation liability

Bring has a limited indemnification liability in accordance with applicable NSAB, The Norwegian Road Carriage Contracts Act, The Norwegian Civil Aviation Act, The Norwegian Maritime Code.

The carrier's compensation liability is limited to the maximum:

Domestic vehicle/Rail transport: SDR* 17) per kg gross weight. **Domestic sea:** 17 SDR*) or **cross-border sea transport:** SDR* 2) per kg gross weight/SDR* 667 per package. **Cross-border vehicle/Rail transport:** SDR* 8.33) per kg gross weight. **Air freight:** SDR* 26) per kg gross weight.

The carrier's liability in the event of delay is limited to the maximum freight amount.

**SDR are supplementary foreign exchange reserve assets defined and maintained by the International Monetary Fund (IMF) and used in international law.*

2.7.3 Insurance of the value of the goods is not covered by Bring's indemnification liability.

Purchase of transport does not include insurance of the value of the goods unless specifically agreed for the individual consignment.

2.7.4 Goods in transit

The customs authorities require information about the goods' contents (goods type) to be stated at the border crossing (transit). Bring complies with the requirements imposed by the customs authorities, and requires the customer/sender to provide information about this in the EDI-message.

Examples of approved goods types may be: office supplies, groceries or industrial goods, or more specific goods types such as clothing, paper, etc. Without exception, field 35 of the EDI-message must contain the aforementioned. It is the customer's responsibility to provide Bring with the necessary information.

Bring is exempt from any liability in the event of delays due to lack of information.

2.8 Terms of payment

2.8.1 Terms of payment

For customers without an invoice/credit agreement, the freight must be paid in advance.

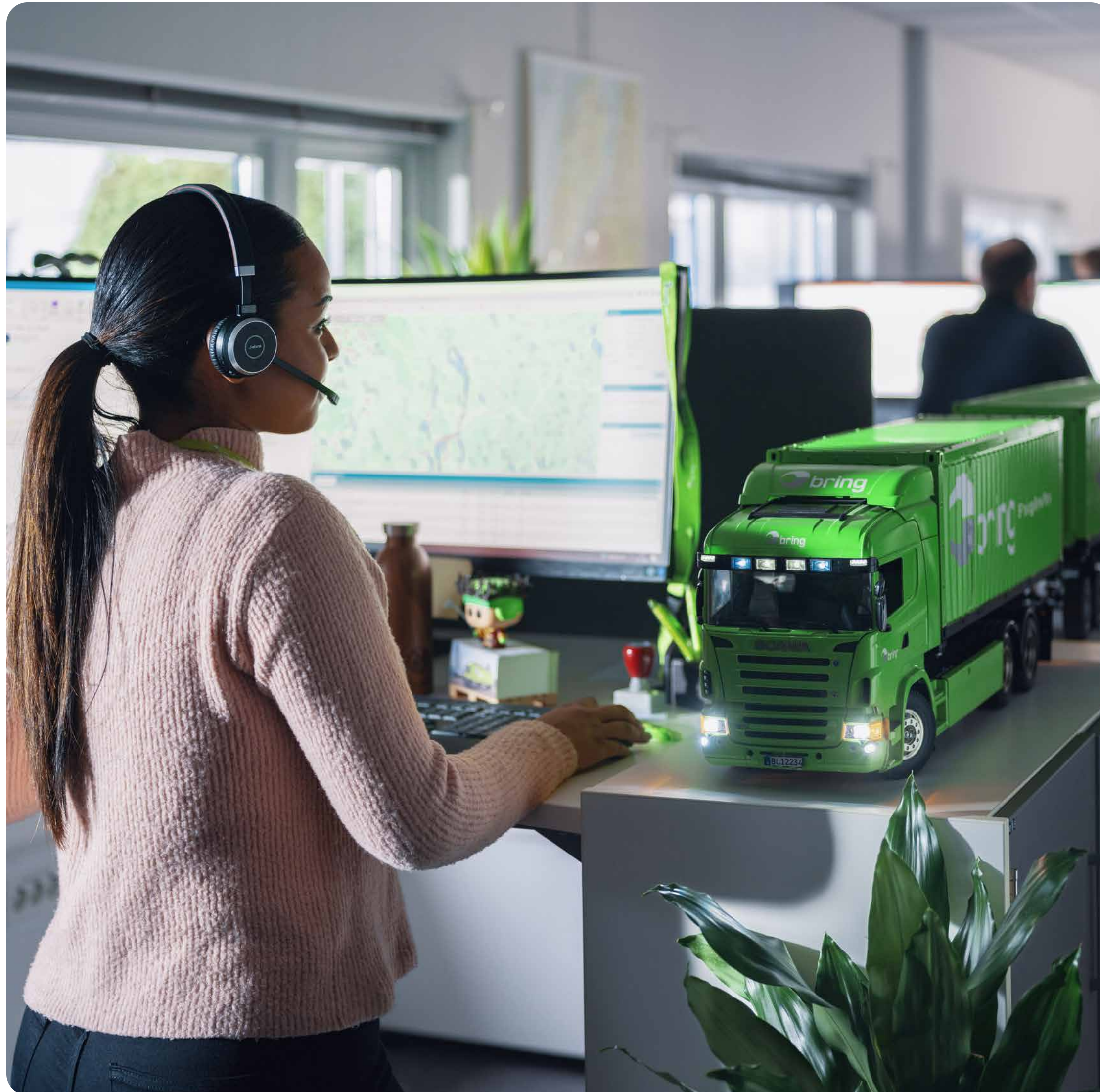

All submitted assignments can be invoiced. It is possible to order the transport of both parcels and goods at Mybring and to pay by card.

2.8.2 Credit

By further agreement, up to 10 days' credit and an agreed credit limit are usually granted. Credit and the credit limit will lapse on any form of payment default. Late payment is subject to late payment interest. The costs of providing credit are not included in the freight between sender and recipient. Priced per invoice. See surcharge. All new customers will be credit assessed by Posten and Bring, and a copy letter stating that this has taken place will be sent to the customer.

2.8.3 Invoicing

All assignments for which credit has been granted will be paid by invoice and payment must be received by Bring by the due date. Any objections to an invoice must have been raised in writing to Bring within 10 days of receipt of the invoice.

2.8.4 Default

In the event of payment default, invoices not yet due are also considered to have fallen due and may be recovered together with overdue claims. Posten and Bring are entitled to set off their outstanding accounts against claims that the customer has against Posten and Bring. The customer may not set off or withhold any money that has fallen due even if freight, damage or loss is claimed.

If the agreed credit limit is exceeded due to payment default or a downgrading of creditworthiness, Posten and Bring may stop the customer's consignments/take out a lien on the customer's goods. In cases where creditworthiness is downgraded, the customer may be offered a new credit agreement against security.

Posten and Bring will determine the security amount. Copies of invoices with specifications are available to our customers in Mybring. Copies of consignment notes or other underlying documents can be obtained upon request or by agreement.

2.8.5 Reminder fees

All assignments for which credit has been granted are paid by invoice and payment must be received by Bring by the due date. Any objections to an invoice must have been raised in writing to Bring within 8 days of receipt of the invoice. In the event of payment default, invoices not yet due are also considered to have fallen due and may be recovered together with overdue claims.

Bring is entitled to set off/retain amounts that have fallen due even if claims have been raised concerning freight, damage or loss.

The reminder fee adheres to the Norwegian Debt Collection Act and the applicable rates at any time. The standard routine for reminders/

debt collection is used for unpaid invoices. In accordance with the Norwegian Act relating to Interest on Overdue Payments. Posten and Bring calculate reminder fees for reminders and debt collection notifications in accordance with standard legislative provisions, at 1/10 of the applicable legal fees.

2.8.6 Freight paid by the recipient

As a general rule, the freight must be paid by the sender. If the freight is to be paid by the recipient, this must be agreed separately, and a surcharge per consignment is calculated. Requires a customer number in Posten Bring AS or Bring.

2.8.7 Third party payer

If the freight is to be paid by a party that is neither the sender nor the recipient, we designate this as a third party. If a third party is accepted as the freight payer, this must be agreed in advance and a freight surcharge will be calculated. We reserve the right to recourse from freight and outlays if the third party does not pay the invoice.

2.9 Claims and indemnification

Bring's indemnification liability is limited to the applicable NSAB, the Norwegian Road Carriage Contracts Act, the Norwegian Civil Aviation Act and the Norwegian Maritime Code in force at any given time. Damage/losses/deficiencies on

delivery must be noted on the consignment note on delivery to both the driver and the recipient. In the case of consignments without a consignment note, the corresponding information must be noted on and registered in the driver's handheld terminal. If the damage is not externally visible, the recipient must notify Bring's Customer Service (Claims Department) in writing without undue delay.

Please note that it is the recipient's responsibility to check the goods before they are signed off as received. If a receipt has been given on the transport document, or the customer has noted the name on the display in the handheld terminal without any comments, it must be assumed that at the time of delivery the goods were in the condition specified on the transport document.

An invoice may not be issued to Posten Bring AS or Bring in claims cases, but a written claim must be submitted via Mybring.

The following documentation is required:
Information: Consignment number and a brief description of the course of events.

Documentation: A copy of the commercial invoice, documentation of the goods' impairment, actual weight of the damaged goods and pictures showing what has been damaged and the relevant items/object(s)/goods. Clear pictures of the damaged goods and their packaging must be attached. In the event of major extensive damage,



the goods must be stored safely so that they can be inspected by the appraiser/insurance company for assessment. The goods must be protected from further damage/loss.

Goods and packaging for which claims have been made must be stored until the matter has been fully processed. Claims must be submitted by the freight payer (the party that paid the freight to Bring). For services with time guarantees, special conditions are specified in the service specification. The period of limitation is one year from delivery of the goods

The carrier's compensation liability is limited to the maximum:

Bring has a limited indemnification liability in accordance with applicable NSAB, The Norwegian Road Carriage Contracts Act, The Norwegian Civil Aviation Act, The Norwegian Maritime Code.'

Domestic vehicle/Rail transport: SDR* 17) per kg gross weight. **Domestic sea:** 17 SDR*) or **cross-border sea transport:** SDR* 2) per kg gross weight/SDR* 667 per package. **Cross-border vehicle/Rail transport:** SDR* 8.33) per kg gross weight. **Air freight:** SDR* 26) per kg gross weight.

The carrier's liability in the event of delay is limited to the maximum freight amount.

Liability is otherwise regulated in accordance with the legislation in force at any given time. For forwarding assignments, liability is regulated in accordance with NSAB 2015 (Nordic Forwarder Federation's General Provisions, except Section 27c, storage), the CMR Convention, the Hague-Visby Convention and the Warsaw Convention.

**SDR are supplementary foreign exchange reserve assets defined and maintained by the International Monetary Found (IMF) and used in international law.*

2.10 Special provisions

Dangerous goods are only received for transportation with specific conditions and and subject to compliance with the applicable regulations. In cases where it has been agreed that the assignment includes dangerous goods, both parties must fulfill their obligations accordance to the applicable regulations such as IMDG/IATA and/or ADR. Consignments within hazard class 1 (explosives) and hazard class 7 (radio active substances) will not be accepted. The only exceptions are within hazard class 1.4S which can be received if there is an approved agreement with the customer.

This also applies to certain UN numbers in the hazard class 7 where it is accepted to transport



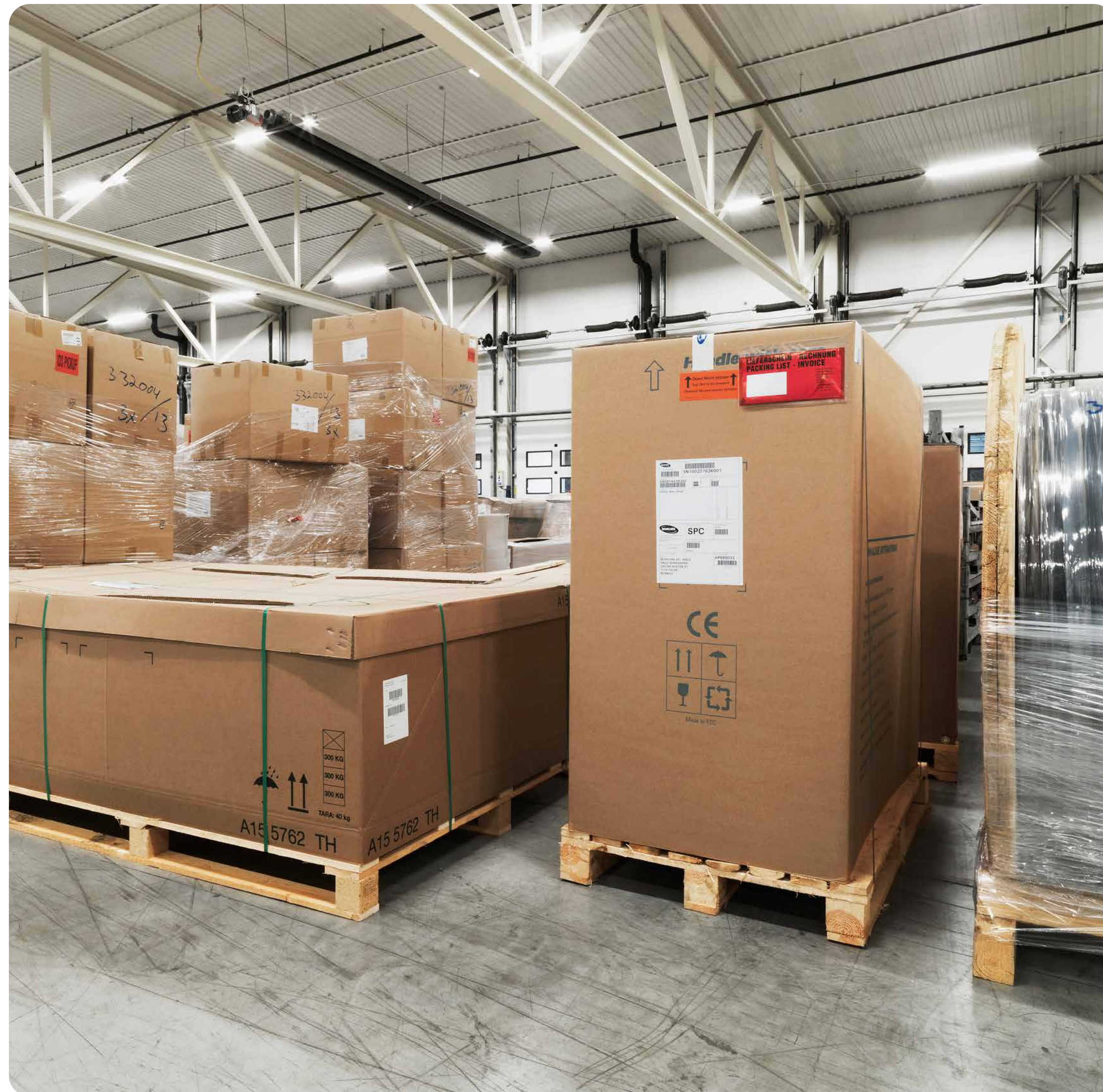

these substances: UN 2908, UN 2909, UN 2910 and UN 2911.

Bring can only accept transportation of dangerous goods by a separate approved agreement.

Dangerous goods, the sender is responsible to ensure that:

- Dangerous goods are reported to Bring in conjunction with booking
- Only goods that is permitted to transport can be handed over to Bring
- The goods are to be packaged, classified and labeled in accordance with the regulations
- Used packaging/labeling is removed
- Transport documents must contain the required information at all times for the applicable regulations as an attached physical document on the consignment. In addition UN numbers and quantity has to be included and specified on the EDI
- The customer is liable to the freight carrier to compensate for any loss and/or damage as a consequence of the obligations not being fulfilled
- Any extra cost, as well as waiting and returns as a consequence of the obligations not being fulfilled will be charged and invoiced to the customer. Bring is liable to the public authorities or third parties due to circumstances that can be attributed to the customer. Bring may claim recourse from the customer

Bring has a duty to reject the goods if:

- It is evident that the goods have not been packed in accordance with ADR regulations
- The packaging has visible damage that could affect safety during transport
- The goods are not labelled in accordance with the regulations
- The necessary documents for performance of transport are missing
- If the consignment includes dangerous goods, and Bring has been made aware of this, the driver can unload the goods without incurring any liability. The driver may destroy or neutralise the goods for the account and risk of the customer when there is reason to believe that the risk cannot be prevented by less invasive measures
- Other conditions where safety (life and health) are considered to be at risk

Dangerous goods are priced with a surcharge of 25% in addition to ordinary freight. Read more about dangerous goods at bring.no. There are specific requirements in relation to the disclosure of information, labelling and the transport of dangerous goods, and these must be complied with. Breach of the liability of the sender/customer will be charged to the freight payer.

Limited quantities

For each UN number, it is stated in the ADR regulations whether the hazardous substance may be transported in limited quantities, or not (ADR



chapter 3.2, Table A, column 7a). If this is not permitted, this is denoted as 0. Dangerous goods that may be transported in limited quantities can be sent as goods or parcels – but not by air. There are clear labelling and packaging requirements. The packaging must be interrelated, i.e. inner and outer packaging. Intermediate packaging may be used if the contents might be exposed to crushing or puncture in normal transport conditions (e.g. glass, porcelain, stoneware, or certain types of plastic).

The maximum gross weight of a package packed according to the regulations concerning limited quantities is 30 kg. The limited quantity packed on a panel with stretch film has a maximum gross weight of 20 kg. No transport document is required for the transport of limited quantities, unless the transport is also to take place by international ship/ferry.

2.10.1 Goods – safety regulations

The carriage of goods is subject to public safety regulations. The sender is obliged to ensure that the contents of the consignment are properly packed and labelled, and that forwarding is permitted in accordance with the applicable safety requirements for the transport in question.

2.10.2 Special freight

Special freight is offered for both Business groupage and Business partloads. The form,

dimensions/weight or content of the consignment may entail that stowage/co-loading in ordinary operations cannot take place. Our services are subject to specifications and requirements from which any deviation may result in the consignment requiring special handling and being changed to another service (e.g. special freight). Bring reserves the right to assess the aforementioned.

A consignment or package is defined as special freight if one or more of these criteria occur

- Weight exceeding 1,200 kg per package
- Has a long side measuring 2.4 m or more.
- Has two sides each measuring 2 m or more.

When a consignment has a freight calculation weight exceeding 3.5 tonnes, this is normally a partload

- A consignment with a real consignment weight of less than 20 kg, and dimensions corresponding to special freight, will not be converted to special goods.

The entire consignment is defined as special freight if this is indicated by the dimensions and weight of at least one package. Consignments are booked and collected by further agreement. Consignments larger than: length 6.0 metres, height 2.4 metres or breadth 2.4 metres require special arrangements.

Contact Customer Service for booking and handling of such consignments.

Labeling and packaging of special freight

There are special requirements for labeling and packaging of special freight as the freight is being handled outdoors. The transport labels must be weatherproof in the sense that they can withstand handling and storage outdoors. On the label it must be stated that the consignment is of the special freight sort. The recipient information must be included and specified on the EDI. Ordering a mobile crane if needed, must be done when ordering pick-up or by agreement in the case of Agreed delivery Notification. No exchange of EUR pallets is offered for special freight.



Part 3 Zones and price lists

MAIN ZONES

- 3.1 Main zone tables for parcels pp. 42-43
- 3.2 Main zone table for Business groupage and Business partloads p. 45

LOCAL ZONES

- 3.3 Local zones Pick-up parcel, Business parcel, Business parcel express, Business groupage and Business partloads pp. 46-104
 - 3.3.1 Local zones Parcels delivered home pp. 105-169

PRICE LISTS FOR PARCELS

- 3.4 Price lists pp. 170-173
 - 3.4.5 Additional prices p. 174
 - 3.4.6 Surcharges p. 174

PRICE LISTS FOR GROUPAGE AND PARTLOADS

- 3.5.1 Price list for Business partloads p. 175
- 3.5.2 Price list for Business groupage pp. 176-178
- 3.5.3 Price list for Business pallets p. 179
- 3.5.4 Additional prices p. 180
- 3.5.5 Surcharges p. 180



3.1 Conversion factors

Services	Conversion factors	Explanation
Parcels	1:5	1 m ³ =200 kg

3.1.1 How to find the price of parcel services

The transport industry uses the freight-calculated weight to calculate the price. The freight-calculated weight is the higher weight between weight by volume and actual/real weight. Calculation of volume is the method used to convert volume to weight and to find the weight by volume.

Pick-up parcel, Business parcel and Business parcel express have the same main zone table. See section 3.1.2 Main zone table for parcels. Parcels delivered home have their own main zone table, see section 3.1.3. Local zones for the Pick-up parcel, Business parcel and Business parcel express services can be found in the same table, see section 3.3. Parcels delivered home have their own local zones, See section 3.3.1 Parcels delivered home local zones.

Weight by volume is found as follows:

1. First, the volume must be found, and then multiplied by length, breadth and height.
2. The volume must be expressed in the correct unit of measurement. Bring uses dm³.
If the measurements are in cm, the result is divided by 1,000 to obtain dm³ (the volume of the consignment).
3. The volume is divided by a fixed conversion factor. For parcels this is 5.0.
You will then have the weight in kilos.

The number of zones is found as follows:

1. All postcodes are linked to a terminal. The list of postcodes shows the number of zones between the relevant postcode and the terminal.
2. The number of zones between the terminals can be found in the zone table for parcels.
3. When you send parcels with Bring, you must look up the sender's postcode and the recipient's postcode to find the number of zones they have, and to which terminals the two postcodes belong. Then you can use the zone table to find the number of zones between the two terminals. The total of all zones is the basis for the freight price. Maximum 8 zones. When the sum of the zones = 0, the total number of zones is rounded up to 1.

Example - From 3110 Tønsberg to 6409 Molde

- A. Postcode 3110 goes via Stokke and has zone 0 into terminal.
- B. Postcode 6409 goes via Molde and has zone 1 out from terminal.
- C. From Stokke to Molde there are 4 zones.
- D. This will be 5 zones in total.

Calculation example for parcels:

We have a Business parcel to be sent from 3110 Tønsberg to 6409 Molde, which we have calculated to be 5 zones. The number of zones can be found in section 3.1 Location and zone register.

1. The parcel measures (LxBxH) 40x20x24 cm and weighs 3 kg.
2. Volume = 40 cm x 20 cm x 24 cm = 19,200 cm³.
3. The result must be divided by 1,000 to get the volume in dm³.
4. 19,200/1000 = 19.2 dm³.

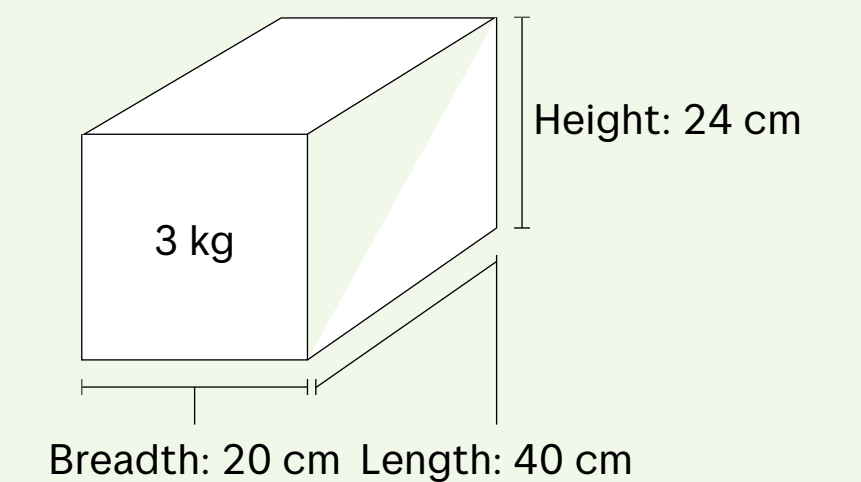

Volume	19,2	= 3,84
Fixed conversion factor:	5	

The freight calculation weight is the higher of the actual weight and weight by volume, and is always rounded up to the nearest whole kilo. In this example, the weight by volume is greatest and the freight calculation weight is therefore 4 kg. The price can be found in weight range 3-4.

4 kg for zone 5 costs NOK 301. Prices are stated excluding VAT.

International services may include customs clearance.

3.1.2 Main zone table for parcels

		1000	1700	2200	2300	2670	3000	3200	3550	4033	4600	5000	5500	6000	6401	6700	6800	6880	7000	7374	8000	8371	8403	8510	8600	8800	8910	9000	9400	9510	9846
1000	Oslo	0	2	2	2	3	2	2	3	3	3	3	3	3	3	4	4	4	3	3	4	5	5	5	5	5	5	4	5	5	5
1700	Fredrikstad	2	0	2	3	3	2	2	3	4	4	4	4	4	4	4	4	4	4	4	5	5	5	5	5	5	5	5	5	5	5
2200	Kongsvinger	2	2	0	2	3	2	2	3	4	3	3	4	4	4	4	4	4	3	3	5	5	5	5	5	5	5	5	5	5	5
2300	Hamar	2	3	2	0	1	2	3	3	4	4	4	4	4	4	4	4	4	3	4	5	5	5	5	5	5	5	5	5	5	5
2670	Otta	3	3	3	1	0	3	3	3	4	4	4	4	4	4	4	4	4	3	4	5	5	5	5	5	5	5	5	5	5	5
3000	Drammen	2	2	2	2	3	0	2	2	3	3	3	3	4	4	4	4	4	3	4	5	5	5	5	5	5	5	5	5	5	5
3200	Stokke	2	2	2	3	3	2	0	2	3	3	4	3	4	4	4	4	4	4	4	5	5	5	5	5	5	5	5	5	5	5
3550	Gol	3	3	3	3	3	2	2	0	4	3	3	3	4	4	4	4	4	4	4	5	5	5	5	5	5	5	5	5	5	5
4033	Stavanger	3	4	4	4	4	3	3	4	0	3	3	2	4	4	4	4	4	4	4	5	5	5	5	5	5	5	5	5	5	5
4600	Kristiansand	3	4	3	4	4	3	3	3	3	0	3	3	4	4	4	4	4	4	4	5	5	5	5	5	5	5	5	5	5	5
5000	Bergen	3	4	3	4	4	3	4	3	3	3	0	2	3	3	3	3	3	3	4	5	5	5	5	5	5	5	5	5	5	5
5500	Haugesund	3	4	4	4	4	3	3	3	2	3	2	0	4	4	4	4	4	4	4	5	5	5	5	5	5	5	5	5	5	5
6000	Ålesund	3	4	4	4	4	4	4	4	4	4	3	4	0	2	3	3	3	3	4	5	5	5	5	5	5	5	5	5	5	5
6401	Molde	3	4	4	4	4	4	4	4	4	4	3	4	2	0	3	3	3	3	4	5	5	5	5	5	5	5	5	5	5	5
6700	Måløy	4	4	4	4	4	4	4	4	4	4	3	4	3	3	0	3	3	4	5	5	5	5	5	5	5	5	5	5	5	5

		1000	1700	2200	2300	2670	3000	3200	3550	4033	4600	5000	5500	6000	6401	6700	6800	6880	7000	7374	8000	8371	8403	8510	8600	8800	8910	9000	9400	9510	9846
6800	Førde	4	4	4	4	4	4	4	4	4	4	3	4	3	3	3	0	2	3	4	5	5	5	5	5	5	5	5	5	5	5
6880	Stryn	4	4	4	4	4	4	4	4	4	4	3	4	3	3	3	2	0	3	4	5	5	5	5	5	5	5	5	5	5	5
7000	Trondheim	3	4	3	3	3	3	4	4	4	4	3	4	3	3	4	3	3	0	2	3	4	5	5	4	4	4	5	5	5	
7374	Røros	3	4	3	4	4	4	4	4	4	4	4	4	4	4	5	4	4	2	0	3	4	4	5	5	4	4	4	5	5	
8000	Fauske	4	5	5	5	5	5	5	5	5	5	5	5	5	5	5	5	5	3	3	0	2	3	2	2	3	4	3	3	4	4
8371	Leknes	5	5	5	5	5	5	5	5	5	5	5	5	5	5	5	5	5	4	4	2	0	3	3	4	5	5	4	4	5	5
8403	Sortland	5	5	5	5	5	5	5	5	5	5	5	5	5	5	5	5	5	5	4	3	3	0	3	4	5	4	4	3	4	5
8510	Narvik	5	5	5	5	5	5	5	5	5	5	5	5	5	5	5	5	5	5	2	3	3	0	4	5	5	3	3	4	5	
8600	Mo i Rana	5	5	5	5	5	5	5	5	5	5	5	5	5	5	5	5	5	4	5	2	4	4	4	0	2	3	4	4	5	5
8800	Sandnessjøen	5	5	5	5	5	5	5	5	5	5	5	5	5	5	5	5	5	4	4	3	5	5	5	2	0	3	4	4	5	5
8910	Brønnøysund	5	5	5	5	5	5	5	5	5	5	5	5	5	5	5	5	5	4	4	4	5	4	5	4	4	0	4	4	5	5
9000	Tromsø	4	5	5	5	5	5	5	5	5	5	5	5	5	5	5	5	5	4	3	4	4	3	5	5	4	0	3	4	4	
9400	Harstad	5	5	5	5	5	5	5	5	5	5	5	5	5	5	5	5	5	5	2	3	3	3	4	4	4	3	0	4	5	
9510	Alta	5	5	5	5	5	5	5	5	5	5	5	5	5	5	5	5	5	5	4	5	4	4	5	5	5	4	4	0	3	
9846	Tana	5	5	5	5	5	5	5	5	5	5	5	5	5	5	5	5	5	5	4	5	5	5	5	5	5	4	5	3	0	

3.2 Conversion factors

Services	Conversion factors	Explanation
Groupage	1:3,5	1m ³ = 286kg
Partloads	1:3	1m ³ = 333kg

3.2.1 How to find the price of Business groupage and Business partloads

The transport industry uses the freight calculation weight to calculate the price. The freight-calculated weight is the higher weight between weight by volume and actual/real weight. Calculation of volume is the method used to convert volume to weight and to find the weight by volume.

Weight by volume can be found as follows:

1. First, you need to find the volume and then multiply it by length, breadth and height.
Each side is rounded up/down to the nearest whole 10 cm.
2. You must have the volume in the correct unit of measurement. Bring uses dm³. If the dimensions are in cm, the result is divided by 1,000 to obtain dm³ (the volume of the consignment)
3. The volume is divided by the fixed conversion factor, which is 3.5 for Business groupage and 3.0 for Business partloads. You will then have a weight in kilos.

For Business groupage, we calculate 1 kg for every 3.5 dm³ of goods, according to the greatest length, breadth and height (in dm). This is why the volume must be divided by the fixed conversion factor; 3.5.

Procedure:

1. All postcodes are linked to a terminal. The list of postcodes shows the number of zones between the relevant postcode and the terminal.
2. The number of zones between the terminals can be found in zone table
3. When you send goods with Bring, you must look up the sender's postcode and the recipient's postcode to find the number of zones they have, and to which terminals the two postcodes belong. Then you can use the zone table to find the number of zones between the two terminals. The total of all zones is the basis for the freight price.

Example - From 3110 Tønsberg to 6409 Molde

- A. Postcode 3110 goes via Stokke and has zone 1 into terminal
- B. Post code 6409 goes via Molde and has zone 0 out from terminal
- C. From Stokke to Molde there are 7 zones
- D. In total, this will be 8 zones

Calculation example for groupage:

Our example is a consignment to be sent from Tønsberg to Molde, which we have found to be 8 zones. The number of zones can be found in section 3.1.2 Location and zone register.

1. The consignment measures (LxBxH) 120x80x90 cm and weighs 220 kg
2. Volume is 120 cm x 80 cm x 90 cm = 864,000 cm³
3. Remember to divide the result by 1,000 to get the volume in dm³
4. 864,00/1,000 = 864 dm³

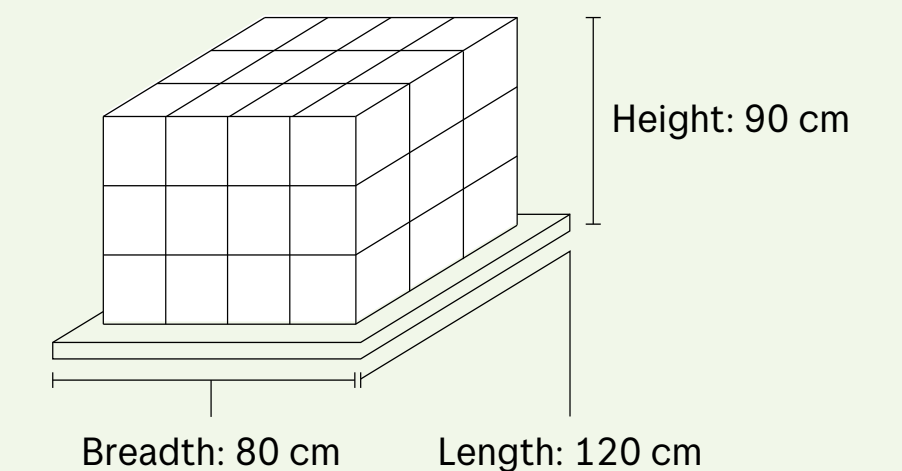

Volume:	864	= 246,9
Fixed conversion factor:	3,5	

The freight calculation weight is the higher of the actual weight and weight by volume, and is always rounded up to the nearest whole kilo. In our example, the weight by volume is greatest and the freight calculation weight is therefore 247 kg. **Prices can be found in the 226-250 weight range. 247 kg for zone 8 costs NOK 2619.**

When a consignment is shipped between two postcodes that belong to the same terminal, it is called local freight. In these consignments, the sum of zones can be 0. In such cases, we will calculate this as 1 zone.

Prices are stated excluding VAT.

3.2.2 Main zone table Before7, Business groupage and Business partloads

		1000	1700	2200	2300	2670	3000	3200	3550	4033	4600	5000	5500	6000	6401	6700	6800	6880	7000	7374	8000	8371	8403	8510	8600	8800	8910	9000	9400	9510	9846
1000 Oslo		0	2	2	2	4	2	2	4	6	4	5	6	6	6	10	6	6	5	4	12	16	16	14	10	12	15	16	16	16	16
1700 Fredrikstad		2	0	3	3	5	3	3	5	7	5	6	7	7	7	11	7	7	6	5	13	17	17	15	11	13	16	17	17	17	17
2200 Kongsvinger		1	2	0	4	6	4	4	6	8	6	7	8	8	8	12	8	8	7	6	14	18	18	16	12	14	17	18	18	18	18
2300 Hamar		1	2	2	0	3	3	3	5	7	5	6	7	7	7	11	7	7	6	5	13	17	17	15	11	13	16	17	17	17	17
2670 Otta		3	4	5	3	0	5	7	9	10	10	9	13	10	12	14	10	10	5	7	16	18	18	18	14	16	18	18	18	18	18
3000 Drammen		1	2	3	3	5	0	1	5	6	4	5	7	7	7	11	7	7	6	5	13	17	17	15	11	13	16	17	17	17	17
3200 Stokke		1	2	3	3	6	1	0	5	6	4	5	7	7	7	11	7	7	6	5	13	17	17	15	11	13	16	17	17	17	17
3550 Gol		2	3	6	3	6	3	3	0	9	7	8	10	10	10	14	10	10	9	8	16	20	20	18	14	16	19	20	20	20	20
4033 Stavanger		4	5	6	6	8	4	4	8	0	4	5	4	8	8	12	8	8	7	6	14	18	18	16	12	14	17	18	18	18	18
4600 Kristiansand		3	4	6	4	8	3	3	8	4	0	7	8	8	8	12	8	8	7	6	14	18	18	16	12	14	17	18	18	18	18
5000 Bergen		3	4	6	4	7	3	3	7	5	6	0	3	6	7	5	3	3	6	10	11	15	14	14	8	9	9	16	14	17	18
5500 Haugesund		5	6	7	6	8	6	6	9	4	8	5	0	8	9	11	10	10	8	13	16	18	18	18	16	17	18	18	18	18	18
6000 Ålesund		5	6	8	5	8	6	6	9	9	9	6	10	0	2	5	3	3	4	7	14	16	16	16	11	12	11	17	16	17	17
6401 Molde		5	6	7	6	8	6	6	9	9	8	6	11	2	0	9	8	8	4	9	13	17	16	16	10	13	11	17	16	16	17
6700 Måløy		10	11	13	11	15	11	11	11	12	14	5	10	4	9	0	2	2	12	12	16	18	18	18	15	16	16	18	18	18	18

		1000	1700	2200	2300	2670	3000	3200	3550	4033	4600	5000	5500	6000	6401	6700	6800	6880	7000	7374	8000	8371	8403	8510	8600	8800	8910	9000	9400	9510	9846
6800 Førde		4	5	5	5	8	5	6	7	8	8	4	8	3	4	2	0	2	9	11	14	16	17	15	12	13	13	17	17	18	18
6880 Stryn		4	5	5	5	8	5	6	7	8	8	4	8	3	4	2	2	0	9	11	14	16	17	15	12	13	13	17	17	18	18
7000 Trondheim		3	4	5	3	5	4	4	7	8	7	6	8	4	4	10	9	9	0	2	9	13	12	12	6	7	7	14	12	15	16
7374 Røros		4	5	10	5	8	5	5	10	12	12	12	14	10	10	14	12	12	2	0	12	16	15	14	9	10	9	16	15	16	17
8000 Fauske		7	8	10	8	11	8	8	12	13	13	13	13	10	9	13	11	11	7	8	0	6	6	6	4	6	11	6	6	10	11
8371 Leknes		14	15	16	15	18	15	15	17	17	17	17	18	16	16	18	17	17	13	15	6	0	3	3	10	12	15	7	3	12	13
8403 Sortland		16	17	16	17	18	17	17	17	17	17	16	18	16	16	18	17	17	10	15	6	3	0	3	10	12	7	5	3	9	12
8510 Narvik		9	10	13	10	13	10	10	14	14	14	13	15	13	13	15	14	14	9	14	6	3	3	0	10	12	13	4	3	9	12
8600 Mo i Rana		6	7	10	7	10	7	7	11	12	10	12	13	9	9	13	10	10	3	6	4	7	7	7	0	1	7	10	7	10	13
8800 Sandnessjøen		9	10	14	10	14	10	10	14	16	14	16	16	12	13	16	14	14	4	10	6	12	12	12	1	0	6	14	9	14	17
8910 Brønnøysund		9	10	15	10	17	10	10	15	18	17	17	16	11	11	16	13	13	4	9	12	5	6	13	10	6	0	6	6	13	13
9000 Tromsø		9	10	14	10	15	10	10	15	15	15	15	15	14	14	15	15	15	9	13	6	7	5	4	10	14	14	0	4	5	8
9400 Harstad		9	10	13	10	13	10	10	14	14	14	13	15	13	13	15	14	14	9	14	6	3	3	3	10	12	13	4	0	9	12
9510 Alta		12	13	17	13	18	13	13	17	18	18	17	18	17	16	18	17	17	12	16	13	12	9	9	13	14	9	5	9	0	5
9846 Tana		12	13	15	13	17	13	13	16	18	18	17	17	15	15	17	16	16	12	14	14	13	12	12	16	17	9	11	12	5	0

3.3 Local zones, collection and delivery*

Postcode	Place	Terminal name	Parcels*		Business parcel express		Business groupage	
			In	Out	In	Out	In	Out
*0001-1299	OSLO	OSLO	0	0	0	0	0	0
0496	OSLO	OSLO	0	1	0	1	0	0
0758	OSLO	OSLO	0	1	0	1	0	0
0782	OSLO	OSLO	0	1	0	1	0	0
0890	OSLO	OSLO	0	1	0	1	0	0
0891	OSLO	OSLO	0	1	0	1	0	0
0957	OSLO	OSLO	0	1	0	1	0	0
1061	OSLO	OSLO	0	1	0	1	0	0
1290	OSLO	OSLO	0	1	0	1	0	0
1311	HØVIKODDEN	OSLO	0	0	0	1	1	1
1336	SANDVIKA	OSLO	0	0	0	1	1	1
1337	SANDVIKA	OSLO	0	0	0	1	1	1
1338	SANDVIKA	OSLO	0	0	0	1	1	1
1339	VØYENENGA	OSLO	0	0	0	1	1	1
1340	SKUI	OSLO	0	1	0	1	1	1
1341	SLEPENDEN	OSLO	0	1	0	1	1	1
1344	HASLUM	OSLO	0	0	0	1	1	1
1346	GJETTUM	OSLO	0	0	0	1	1	1
1348	RYKKINN	OSLO	0	0	0	1	1	1
1349	RYKKINN	OSLO	0	0	0	1	1	1
1350	LOMMEDALEN	OSLO	0	1	0	0	1	1
1351	RUD	OSLO	0	0	0	1	1	1
1352	KOLSÅS	OSLO	0	0	0	1	1	1
1353	BÆRUMS VERK	OSLO	0	0	0	0	1	1
1354	BÆRUMS VERK	OSLO	0	0	0	0	1	1

Postcode	Place	Terminal name	Parcels*		Business parcel express		Business groupage	
			In	Out	In	Out	In	Out
1356	BEKKESTUA	OSLO	0	0	0	1	1	1
1357	BEKKESTUA	OSLO	0	0	0	1	1	1
1358	JAR	OSLO	0	0	0	1	1	1
1359	EIKSMARKA	OSLO	0	0	0	1	1	1
1360	FORNEBU	OSLO	0	0	0	1	1	1
1361	ØSTERÅS	OSLO	0	0	0	1	1	1
1362	HOSLE	OSLO	0	0	0	1	1	1
1363	HØVIK	OSLO	0	0	0	1	1	1
1364	FORNEBU	OSLO	0	0	0	1	1	1
1365	BLOMMENHOLM	OSLO	0	0	0	1	1	1
1366	LYSAKER	OSLO	0	0	0	1	1	1
1367	SNARØYA	OSLO	0	1	0	1	1	1
1368	STABEKK	OSLO	0	0	0	1	1	1
1369	STABEKK	OSLO	0	0	0	1	1	1
1383	ASKER	OSLO	0	0	0	1	1	1
1384	ASKER	OSLO	0	1	0	1	1	1
1385	ASKER	OSLO	0	0	0	1	1	1
1386	ASKER	OSLO	0	0	0	1	1	1
1387	ASKER	OSLO	0	0	0	1	1	1
1388	BORGEN	OSLO	1	1	0	1	2	2
1389	HEGGEDAL	OSLO	1	1	0	0	2	2
1390	VOLLEN	OSLO	1	1	0	0	2	2
1391	VOLLEN	OSLO	1	1	0	0	2	2
1392	VETTRE	OSLO	0	1	0	1	1	1
1394	NESBRU	OSLO	0	0	0	1	1	1

*Pick-up parcel and Business parcel

Postcode	Place	Terminal name	Parcels*		Business parcel express		Business groupage	
			In	Out	In	Out	In	Out
1395	HVALSTAD	OSLO	0	0	0	1	1	1
1396	BILLINGSTAD	OSLO	0	0	0	1	1	1
1397	NESØYA	OSLO	0	0	0	1	1	1
1400	SKI	OSLO	0	0	0	1	1	1
1404	SIGGERUD	OSLO	0	1	0	0	1	1
1405	LANGHUS	OSLO	0	0	0	1	1	1
1406	SKI	OSLO	0	0	0	1	1	1
1407	VINTERBRO	OSLO	0	0	0	0	1	1
1408	KRÅKSTAD	OSLO	0	1	0	0	1	1
1409	SKOTBU	OSLO	0	1	0	0	1	1
1410	KOLBOTN	OSLO	0	0	0	1	1	1
1412	SOFIEMYR	OSLO	0	0	0	1	1	1
1413	TÅRNÅSEN	OSLO	0	0	0	1	1	1
1414	TROLLÅSEN	OSLO	0	0	0	1	1	1
1415	OPPEGÅRD	OSLO	0	0	0	1	1	1
1420	SVARTSKOG	OSLO	0	1	0	1	1	1
1423	SKI	OSLO	0	0	0	1	1	1
1424	SKI	OSLO	0	0	0	1	1	1
1425	SKI	OSLO	0	0	0	1	1	1
1430	ÅS	OSLO	1	1	0	1	2	2
1433	ÅS	OSLO	1	1	0	1	2	2
1434	ÅS	OSLO	1	1	0	1	2	2
1435	ÅS	OSLO	1	1	0	1	2	2
1440	DRØBAK	OSLO	1	0	0	1	2	2
1443	DRØBAK	OSLO	1	1	0	1	2	2

Postcode	Place	Terminal name	Parcels*		Business parcel express		Business groupage	
			In	Out	In	Out	In	Out
1444	DRØBAK	OSLO	1	1	0	1	2	2
1445	DRØBAK	OSLO	1	1	0	1	2	2
1446	DRØBAK	OSLO	1	1	0	1	2	2
1447	DRØBAK	OSLO	1	1	0	1	2	2
1448	DRØBAK	OSLO	1	0	0	1	2	2
1449	DRØBAK	OSLO	1	1	0	1	2	2
1450	NESODDTANGEN	OSLO	1	1	0	1	3	3
1452	NESODDTANGEN	OSLO	1	1	0	1	3	3
1453	BJØRNEMYR	OSLO	1	1	0	1	3	3
1454	FAGERSTRAND	OSLO	1	1	0	1	3	3
1455	NORDRE FROGN	OSLO	1	1	0	1	3	3
1456	NESODDTANGEN	OSLO	1	1	0	1	3	3
1458	FJELLSTRAND	OSLO	1	1	0	1	3	3
1459	NESODDEN	OSLO	1	1	0	1	3	3
1461	LØRENSKOG	OSLO	0	0	0	1	3	3
1462	FJELLHAMAR	OSLO	0	0	0	1	3	3
1463	FJELLHAMAR	OSLO	0	0	0	1	3	3
1464	FJELLHAMAR	OSLO	0	0	0	1	3	3
1465	STRØMMEN	OSLO	0	0	0	1	1	1
1466	STRØMMEN	OSLO	0	0	0	1	1	1
1467	STRØMMEN	OSLO	0	0	0	1	1	1
1470	LØRENSKOG	OSLO	0	0	0	1	0	0
1472	FJELLHAMAR	OSLO	0	0	0	1	0	0
1473	LØRENSKOG	OSLO	0	0	0	1	0	0
1474	LØRENSKOG	OSLO	0	0	0	1	0	0

Postcode	Place	Terminal name	Parcels*		Business parcel express		Business groupage	
			In	Out	In	Out	In	Out
1475	FINSTADJORDET	OSLO	0	1	0	1	0	0
1476	RASTA	OSLO	0	0	0	1	0	0
1479	KURLAND	OSLO	0	0	0	1	0	0
1480	SLATTUM	OSLO	0	1	0	0	1	1
1481	HAGAN	OSLO	0	0	0	0	1	1
1482	NITTEDAL	OSLO	0	1	0	0	1	1
1484	HAKADAL	OSLO	0	1	0	0	1	1
1487	HAKADAL	OSLO	0	1	0	0	1	1
1488	HAKADAL	OSLO	0	1	0	0	1	1
1511	MOSS	FREDRIKSTAD	0	0	0	1	0	0
1512	MOSS	FREDRIKSTAD	0	0	0	1	0	0
1513	MOSS	FREDRIKSTAD	0	0	0	1	0	0
1514	MOSS	FREDRIKSTAD	0	1	0	0	0	0
1515	MOSS	FREDRIKSTAD	0	0	0	1	0	0
1516	MOSS	FREDRIKSTAD	0	0	0	1	0	0
1517	MOSS	FREDRIKSTAD	0	0	0	1	0	0
1518	MOSS	FREDRIKSTAD	0	0	0	1	0	0
1519	MOSS	FREDRIKSTAD	0	1	0	1	0	0
1523	MOSS	FREDRIKSTAD	0	0	0	1	0	0
1524	MOSS	FREDRIKSTAD	0	0	0	1	0	0
1525	MOSS	FREDRIKSTAD	0	1	0	1	0	0
1526	MOSS	FREDRIKSTAD	0	0	0	1	0	0
1528	MOSS	FREDRIKSTAD	0	0	0	1	0	0
1529	MOSS	FREDRIKSTAD	0	0	0	1	0	0
1530	MOSS	FREDRIKSTAD	0	0	0	1	0	0

Postcode	Place	Terminal name	Parcels*		Business parcel express		Business groupage	
			In	Out	In	Out	In	Out
1531	MOSS	FREDRIKSTAD	0	0	0	1	0	0
1532	MOSS	FREDRIKSTAD	0	0	0	1	0	0
1533	MOSS	FREDRIKSTAD	0	0	0	1	0	0
1534	MOSS	FREDRIKSTAD	0	0	0	1	0	0
1535	MOSS	FREDRIKSTAD	0	0	0	1	0	0
1536	MOSS	FREDRIKSTAD	0	0	0	1	0	0
1537	MOSS	FREDRIKSTAD	0	0	0	1	0	0
1538	MOSS	FREDRIKSTAD	0	0	0	1	0	0
1539	MOSS	FREDRIKSTAD	0	0	0	1	0	0
1540	VESTBY	FREDRIKSTAD	0	1	0	0	0	0
1542	VESTBY	FREDRIKSTAD	0	0	0	0	0	0
1543	VESTBY	FREDRIKSTAD	0	0	0	0	0	0
1544	VESTBY	FREDRIKSTAD	1	1	0	1	0	0
1545	HVITSTEN	FREDRIKSTAD	1	1	0	1	2	2
1550	HØLEN	FREDRIKSTAD	1	1	0	1	3	3
1553	SON	FREDRIKSTAD	1	1	0	1	3	3
1554	SON	FREDRIKSTAD	1	1	0	1	3	3
1555	SON	FREDRIKSTAD	1	1	0	1	3	3
1560	LARKOLLEN	FREDRIKSTAD	1	1	0	1	3	3
1570	DILLING	FREDRIKSTAD	0	1	0	0	0	0
1580	RYGGE	FREDRIKSTAD	1	1	0	1	2	2
1591	SPERREBOTN	FREDRIKSTAD	1	1	0	1	4	4
1592	VÅLER I ØSTFOLD	FREDRIKSTAD	1	1	0	1	3	3
1593	SVINNDAL	FREDRIKSTAD	1	2	0	1	4	4
1596	MOSS	FREDRIKSTAD	0	0	0	1	0	0

Postcode	Place	Terminal name	Parcels*		Business parcel express		Business groupage	
			In	Out	In	Out	In	Out
1597	MOSS	FREDRIKSTAD	0	0	0	1	0	0
1598	MOSS	FREDRIKSTAD	0	0	0	1	0	0
1599	MOSS	FREDRIKSTAD	0	0	0	1	0	0
1604	FREDRIKSTAD	FREDRIKSTAD	0	0	0	1	0	0
1605	FREDRIKSTAD	FREDRIKSTAD	0	0	0	1	0	0
1606	FREDRIKSTAD	FREDRIKSTAD	0	0	0	1	0	0
1607	FREDRIKSTAD	FREDRIKSTAD	0	0	0	1	0	0
1608	FREDRIKSTAD	FREDRIKSTAD	0	0	0	1	0	0
1610	FREDRIKSTAD	FREDRIKSTAD	0	0	0	1	0	0
1613	FREDRIKSTAD	FREDRIKSTAD	0	0	0	1	0	0
1614	FREDRIKSTAD	FREDRIKSTAD	0	0	0	1	0	0
1615	FREDRIKSTAD	FREDRIKSTAD	0	1	0	0	0	0
1617	FREDRIKSTAD	FREDRIKSTAD	0	0	0	1	0	0
1618	FREDRIKSTAD	FREDRIKSTAD	0	0	0	1	0	0
1619	FREDRIKSTAD	FREDRIKSTAD	0	0	0	1	0	0
1621	GRESSVIK	FREDRIKSTAD	1	1	0	1	3	3
1622	GRESSVIK	FREDRIKSTAD	1	1	0	1	4	4
1623	GRESSVIK	FREDRIKSTAD	1	1	0	1	3	3
1624	GRESSVIK	FREDRIKSTAD	1	1	0	1	2	2
1626	MANSTAD	FREDRIKSTAD	1	1	0	1	4	4
1628	ENGELSVIKEN	FREDRIKSTAD	1	1	0	1	2	2
1630	GAMLE FREDRIKSTAD	FREDRIKSTAD	0	0	0	1	0	0
1632	GAMLE FREDRIKSTAD	FREDRIKSTAD	0	0	0	1	0	0
1633	GAMLE FREDRIKSTAD	FREDRIKSTAD	0	0	0	1	0	0
1634	GAMLE FREDRIKSTAD	FREDRIKSTAD	0	1	0	0	0	0

Postcode	Place	Terminal name	Parcels*		Business parcel express		Business groupage	
			In	Out	In	Out	In	Out
1636	GAMLE FREDRIKSTAD	FREDRIKSTAD	0	0	0	1	0	0
1637	GAMLE FREDRIKSTAD	FREDRIKSTAD	0	0	0	1	0	0
1639	GAMLE FREDRIKSTAD	FREDRIKSTAD	0	0	0	1	0	0
1640	RÅDE	FREDRIKSTAD	0	1	0	0	1	1
1642	SALTNES	FREDRIKSTAD	1	1	0	1	4	4
1643	RÅDE	FREDRIKSTAD	1	1	0	1	4	4
1651	SELLEBAKK	FREDRIKSTAD	1	0	0	1	2	2
1653	SELLEBAKK	FREDRIKSTAD	1	0	0	1	2	2
1654	SELLEBAKK	FREDRIKSTAD	1	1	0	1	2	2
1655	SELLEBAKK	FREDRIKSTAD	1	1	0	0	2	2
1657	TORP	FREDRIKSTAD	1	1	0	1	3	3
1658	TORP	FREDRIKSTAD	1	1	0	1	3	3
1659	TORP	FREDRIKSTAD	1	1	0	1	3	3
1661	ROLVSØY	FREDRIKSTAD	0	0	0	1	0	0
1663	ROLVSØY	FREDRIKSTAD	0	0	0	1	0	0
1664	ROLVSØY	FREDRIKSTAD	0	0	0	1	0	0
1665	ROLVSØY	FREDRIKSTAD	0	1	0	1	0	0
1666	ROLVSØY	FREDRIKSTAD	0	0	0	1	0	0
1667	ROLVSØY	FREDRIKSTAD	0	1	0	0	0	0
1671	KRÅKERØY	FREDRIKSTAD	1	1	0	1	2	2
1672	KRÅKERØY	FREDRIKSTAD	1	1	0	1	2	2
1673	KRÅKERØY	FREDRIKSTAD	1	1	0	1	2	2
1675	KRÅKERØY	FREDRIKSTAD	1	1	0	0	2	2
1676	KRÅKERØY	FREDRIKSTAD	1	1	0	0	2	2
1678	KRÅKERØY	FREDRIKSTAD	1	1	0	1	2	2

Postcode	Place	Terminal name	Parcels*		Business parcel express		Business groupage	
			In	Out	In	Out	In	Out
1679	KRÅKERØY	FREDRIKSTAD	1	1	0	1	2	2
1680	SKJÆRHALDEN	FREDRIKSTAD	1	2	0	1	5	5
1684	VESTERØY	FREDRIKSTAD	1	2	0	1	5	5
1690	HERFØL	FREDRIKSTAD	1	2	0	1	6	6
1692	NEDGÅRDEN	FREDRIKSTAD	1	2	0	1	6	6
1706	SARPSBORG	FREDRIKSTAD	0	0	0	1	0	0
1707	SARPSBORG	FREDRIKSTAD	0	0	0	1	0	0
1708	SARPSBORG	FREDRIKSTAD	0	1	0	0	0	0
1709	SARPSBORG	FREDRIKSTAD	0	0	0	1	0	0
1710	SARPSBORG	FREDRIKSTAD	0	0	0	1	0	0
1711	SARPSBORG	FREDRIKSTAD	0	1	0	1	0	0
1712	GRÅLUM	FREDRIKSTAD	0	0	0	1	1	1
1714	GRÅLUM	FREDRIKSTAD	0	1	0	0	1	1
1715	YVEN	FREDRIKSTAD	1	1	0	1	2	2
1718	GREÅKER	FREDRIKSTAD	0	0	0	1	0	0
1719	GREÅKER	FREDRIKSTAD	0	1	0	1	0	0
1721	SARPSBORG	FREDRIKSTAD	0	0	0	1	0	0
1722	SARPSBORG	FREDRIKSTAD	0	0	0	1	0	0
1723	SARPSBORG	FREDRIKSTAD	0	0	0	1	0	0
1724	SARPSBORG	FREDRIKSTAD	0	0	0	1	0	0
1725	SARPSBORG	FREDRIKSTAD	0	0	0	1	0	0
1726	SARPSBORG	FREDRIKSTAD	0	0	0	1	0	0
1727	SARPSBORG	FREDRIKSTAD	0	0	0	1	0	0
1730	ISE	FREDRIKSTAD	1	1	0	0	4	4
1734	HAFSLUNDSØY	FREDRIKSTAD	1	1	0	1	2	2

Postcode	Place	Terminal name	Parcels*		Business parcel express		Business groupage	
			In	Out	In	Out	In	Out
1735	VARTEIG	FREDRIKSTAD	1	1	0	0	4	4
1738	BORGENHAUGEN	FREDRIKSTAD	1	1	0	1	2	2
1739	BORGENHAUGEN	FREDRIKSTAD	1	1	0	1	2	2
1743	KLAVESTADHAUGEN	FREDRIKSTAD	1	1	0	0	2	2
1746	SKJEBERG	FREDRIKSTAD	1	1	0	0	2	2
1747	SKJEBERG	FREDRIKSTAD	1	1	0	0	2	2
1763	HALDEN	FREDRIKSTAD	1	1	0	0	2	2
1764	HALDEN	FREDRIKSTAD	1	2	0	0	2	2
1765	HALDEN	FREDRIKSTAD	1	2	0	0	2	2
1766	HALDEN	FREDRIKSTAD	1	2	0	0	2	2
1767	HALDEN	FREDRIKSTAD	1	0	0	1	2	2
1768	HALDEN	FREDRIKSTAD	1	1	0	1	2	2
1769	HALDEN	FREDRIKSTAD	1	1	0	1	2	2
1771	HALDEN	FREDRIKSTAD	1	0	0	1	2	2
1772	HALDEN	FREDRIKSTAD	1	0	0	1	2	2
1776	HALDEN	FREDRIKSTAD	1	0	0	1	2	2
1777	HALDEN	FREDRIKSTAD	1	0	0	1	2	2
1778	HALDEN	FREDRIKSTAD	1	1	0	1	2	2
1779	HALDEN	FREDRIKSTAD	1	0	0	1	2	2
1781	HALDEN	FREDRIKSTAD	1	0	0	1	2	2
1782	HALDEN	FREDRIKSTAD	1	1	0	1	2	2
1783	HALDEN	FREDRIKSTAD	1	1	0	1	2	2
1784	HALDEN	FREDRIKSTAD	1	1	0	1	2	2
1785	HALDEN	FREDRIKSTAD	1	1	0	1	2	2
1786	HALDEN	FREDRIKSTAD	1	1	0	1	2	2

Postcode	Place	Terminal name	Parcels*		Business parcel express		Business groupage	
			In	Out	In	Out	In	Out
1788	HALDEN	FREDRIKSTAD	1	1	0	1	2	2
1789	BERG I ØSTFOLD	FREDRIKSTAD	1	1	0	0	2	2
1791	TISTEDAL	FREDRIKSTAD	1	1	0	1	3	3
1792	TISTEDAL	FREDRIKSTAD	1	1	0	1	3	3
1793	TISTEDAL	FREDRIKSTAD	1	1	0	1	3	3
1794	SPONVIKA	FREDRIKSTAD	1	1	0	1	3	3
1796	KORNSJØ	FREDRIKSTAD	1	2	0	1	6	6
1798	AREMARK	FREDRIKSTAD	1	2	0	1	5	5
1807	ASKIM	OSLO	1	0	0	1	3	3
1808	ASKIM	OSLO	1	1	0	1	3	3
1809	ASKIM	OSLO	1	1	0	1	3	3
1811	ASKIM	OSLO	1	1	0	1	3	3
1812	ASKIM	OSLO	1	1	0	1	3	3
1813	ASKIM	OSLO	1	1	0	1	3	3
1814	ASKIM	OSLO	1	1	0	1	3	3
1815	ASKIM	OSLO	1	1	0	1	3	3
1816	SKIPTVET	OSLO	1	1	0	1	4	4
1820	SPYDEBERG	OSLO	1	1	0	1	4	4
1821	SPYDEBERG	OSLO	1	1	0	1	4	4
1823	KNAPSTAD	OSLO	1	1	0	1	4	4
1825	TOMTER	OSLO	1	1	0	1	4	4
1827	HOBØL	OSLO	1	1	0	1	4	4
1830	ASKIM	OSLO	1	1	0	1	3	3
1831	ASKIM	OSLO	1	0	0	1	3	3
1832	ASKIM	OSLO	1	1	0	1	3	3

Postcode	Place	Terminal name	Parcels*		Business parcel express		Business groupage	
			In	Out	In	Out	In	Out
1850	MYSEN	OSLO	1	1	0	1	4	4
1852	MYSEN	OSLO	1	1	0	1	4	4
1859	SLITU	OSLO	1	1	0	1	4	4
1860	TRØGSTAD	OSLO	1	1	0	1	4	4
1866	BÅSTAD	OSLO	1	1	0	1	4	4
1870	ØRJE	OSLO	1	2	0	1	4	4
1875	OTTEID	OSLO	1	2	0	1	4	4
1878	HÆRLAND	OSLO	1	1	0	1	4	4
1880	EIDSBERG	OSLO	1	1	0	1	4	4
1890	RAKKESTAD	FREDRIKSTAD	1	2	0	1	5	5
1892	DEGERNES	FREDRIKSTAD	1	2	0	1	4	4
1894	RAKKESTAD	FREDRIKSTAD	1	1	0	1	6	6
1900	FETSUND	OSLO	0	1	0	0	1	1
1903	GAN	OSLO	1	1	0	1	3	3
1910	ENEBAKKNESET	OSLO	1	2	0	1	3	3
1911	FLATEBY	OSLO	1	1	0	1	3	3
1912	ENEBAKK	OSLO	1	1	0	1	3	3
1914	YTRE ENEBAKK	OSLO	1	1	0	1	4	4
1920	SØRUMSAND	OSLO	1	1	0	1	3	3
1923	SØRUM	OSLO	1	1	0	1	3	3
1925	BLAKER	OSLO	1	1	0	1	4	4
1927	RÅNÅSFOSS	OSLO	1	1	0	1	4	4
1929	AULI	OSLO	1	1	0	1	3	3
1930	AURSKOG	OSLO	1	1	0	1	3	3
1940	BJØRKELANGEN	OSLO	1	1	0	1	3	3

Postcode	Place	Terminal name	Parcels*		Business parcel express		Business groupage	
			In	Out	In	Out	In	Out
1950	RØMSKOG	OSLO	1	2	0	1	4	4
1954	SETSKOG	OSLO	1	2	0	1	4	4
1960	LØKEN	OSLO	1	1	0	1	4	4
1963	FOSSER	OSLO	1	1	0	1	4	4
1970	HEMNES	OSLO	1	2	0	1	4	4
2000	LILLESTRØM	OSLO	0	0	0	1	1	1
2003	LILLESTRØM	OSLO	0	0	0	1	1	1
2004	LILLESTRØM	OSLO	0	0	0	1	1	1
2005	RÆLINGEN	OSLO	0	0	0	0	1	1
2006	LØVENSTAD	OSLO	0	0	0	0	1	1
2007	KJELLER	OSLO	0	0	0	1	1	1
2008	FJERDINGBY	OSLO	1	1	0	1	2	2
2009	NORDBY	OSLO	1	1	0	1	2	2
2010	STRØMMEN	OSLO	0	0	0	1	1	1
2013	SKJETTEN	OSLO	0	0	0	1	1	1
2014	BLYSTADLIA	OSLO	0	0	0	0	1	1
2015	LEIRSUND	OSLO	1	1	0	1	2	2
2016	FROGNER	OSLO	1	1	0	1	2	2
2019	SKEDSMOKORSET	OSLO	0	0	0	1	1	1
2020	SKEDSMOKORSET	OSLO	0	0	0	1	1	1
2022	GJERDRUM	OSLO	1	1	0	1	3	3
2030	NANNESTAD	OSLO	1	1	0	1	3	3
2032	MAURA	OSLO	1	1	0	1	4	4
2033	ÅSGREINA	OSLO	1	1	0	1	3	3
2034	HOLTER	OSLO	1	1	0	1	4	4

Postcode	Place	Terminal name	Parcels*		Business parcel express		Business groupage	
			In	Out	In	Out	In	Out
2040	KLØFTA	OSLO	1	1	0	1	2	2
2050	JESSHEIM	OSLO	1	1	0	1	2	2
2052	JESSHEIM	OSLO	1	1	0	1	2	2
2053	JESSHEIM	OSLO	1	1	0	1	2	2
2054	MOGREINA	OSLO	1	1	0	1	4	4
2055	NORDKISA	OSLO	1	1	0	1	4	4
2056	ALGARHEIM	OSLO	1	1	0	1	2	2
2058	SESSVOLLMOEN	OSLO	1	1	0	1	4	4
2060	GARDERMOEN	OSLO	1	1	0	1	2	2
2063	JESSHEIM	OSLO	1	0	0	1	2	2
2066	JESSHEIM	OSLO	1	1	0	1	2	2
2067	JESSHEIM	OSLO	1	1	0	1	2	2
2068	JESSHEIM	OSLO	1	1	0	1	2	2
2069	JESSHEIM	OSLO	1	1	0	1	2	2
2070	RÅHOLT	OSLO	1	1	0	1	4	4
2072	DAL	OSLO	1	1	0	1	3	3
2073	BØN	OSLO	1	1	0	1	3	3
2074	EIDSVOLL VERK	OSLO	1	1	0	1	4	4
2080	EIDSVOLL	OSLO	1	1	0	1	4	4
2090	HURDAL	OSLO	1	2	0	1	4	4
2092	MINNESUND	OSLO	1	1	0	1	4	4
2093	FEIRING	OSLO	1	2	0	1	4	4
2100	SKARNES	KONGSVINGER	0	0	0	0	1	1
2110	SLÅSTAD	KONGSVINGER	1	2	0	1	3	3
2114	DISENÅ	KONGSVINGER	1	2	0	1	2	2

Postcode	Place	Terminal name	Parcels*		Business parcel express		Business groupage	
			In	Out	In	Out	In	Out
2116	SANDER	KONGSVINGER	1	2	0	1	2	2
2120	SAGSTUA	KONGSVINGER	1	1	0	1	2	2
2123	BRUVOLL	KONGSVINGER	1	2	0	1	3	3
2130	KNAPPER	KONGSVINGER	1	2	0	1	4	4
2133	GARDVIK	KONGSVINGER	1	1	0	1	4	4
2134	AUSTVATN	KONGSVINGER	1	2	0	1	4	4
2150	ÅRNES	OSLO	1	1	0	1	4	4
2160	VORMSUND	OSLO	1	1	0	1	4	4
2162	BRÅRUD	OSLO	1	1	0	1	4	4
2164	SKOGBYGDA	OSLO	1	2	0	1	4	4
2165	HVAM	OSLO	1	1	0	1	4	4
2166	OPPAKER	OSLO	1	1	0	1	4	4
2170	FENSTAD	OSLO	1	1	0	1	4	4
2208	KONGSVINGER	KONGSVINGER	0	1	0	1	0	0
2209	KONGSVINGER	KONGSVINGER	0	1	0	1	0	0
2210	GRANLI	KONGSVINGER	0	1	0	1	2	2
2211	KONGSVINGER	KONGSVINGER	0	1	0	1	0	0
2212	KONGSVINGER	KONGSVINGER	0	0	0	1	0	0
2213	KONGSVINGER	KONGSVINGER	0	1	0	1	0	0
2214	KONGSVINGER	KONGSVINGER	0	0	0	1	0	0
2216	ROVERUD	KONGSVINGER	1	1	0	1	2	2
2217	HOKKÅSEN	KONGSVINGER	1	2	0	1	3	3
2218	LUNDERSÆTER	KONGSVINGER	1	2	0	1	4	4
2219	BRANDVAL	KONGSVINGER	1	2	0	1	3	3
2220	ÅBOGEN	KONGSVINGER	1	2	0	1	3	3

Postcode	Place	Terminal name	Parcels*		Business parcel express		Business groupage	
			In	Out	In	Out	In	Out
2223	GALTERUD	KONGSVINGER	1	2	0	1	3	3
2224	AUSTMARKA	KONGSVINGER	1	2	0	1	4	4
2230	SKOTTERUD	KONGSVINGER	1	1	0	1	2	2
2232	TOBØL	KONGSVINGER	1	2	0	1	3	3
2233	VESTMARKA	KONGSVINGER	1	2	0	1	3	3
2235	MATRAND	KONGSVINGER	1	1	0	1	3	3
2240	MAGNOR	KONGSVINGER	1	1	0	1	2	2
2256	GRUE FINNSKOG	KONGSVINGER	1	2	0	2	5	5
2260	KIRKENÆR	KONGSVINGER	1	1	0	1	3	3
2264	GRINDER	KONGSVINGER	1	1	0	1	3	3
2265	NAMNÅ	KONGSVINGER	1	2	0	1	4	4
2266	ARNEBERG	KONGSVINGER	1	2	0	1	4	4
2270	FLISA	KONGSVINGER	1	1	0	1	4	4
2280	GJESÅSEN	KONGSVINGER	1	2	0	1	4	4
2283	ÅSNES FINNSKOG	KONGSVINGER	1	2	0	2	5	5
2312	OTTESTAD	HAMAR	0	1	0	0	1	1
2315	HAMAR	HAMAR	0	0	0	1	0	0
2316	HAMAR	HAMAR	0	0	0	1	0	0
2317	HAMAR	HAMAR	0	0	0	1	0	0
2318	HAMAR	HAMAR	0	0	0	1	0	0
2319	HAMAR	HAMAR	0	0	0	1	0	0
2320	FURNES	HAMAR	0	0	0	1	0	0
2321	HAMAR	HAMAR	0	0	0	1	0	0
2322	RIDABU	HAMAR	0	1	0	1	0	0
2323	INGEBERG	HAMAR	0	1	0	0	0	0

Postcode	Place	Terminal name	Parcels*		Business parcel express		Business groupage	
			In	Out	In	Out	In	Out
2324	VANG PÅ HEDMARKEN	HAMAR	1	2	0	0	2	2
2330	VALLSET	HAMAR	1	2	0	0	3	3
2332	ÅSVANG	HAMAR	1	1	0	0	3	3
2334	ROMEDAL	HAMAR	1	1	0	0	2	2
2335	STANGE	HAMAR	0	1	0	0	1	1
2337	TANGEN	HAMAR	1	1	0	1	2	2
2338	ESPA	HAMAR	1	1	0	1	3	3
2340	LØTEN	HAMAR	1	1	0	1	2	2
2344	ILSENG	HAMAR	1	1	0	1	2	2
2345	ÅDALSBRUK	HAMAR	1	1	0	1	3	3
2350	NES PÅ HEDMARKEN	HAMAR	1	1	0	1	3	3
2353	STAVSJØ	HAMAR	1	1	0	1	3	3
2355	GAUPEN	HAMAR	1	1	0	0	3	3
2360	RUDSHØGDA	HAMAR	1	1	0	0	2	2
2364	NÆROSET	HAMAR	1	1	0	0	3	3
2365	ÅSMARKA	HAMAR	1	2	0	1	3	3
2372	BRØTTUM	HAMAR	1	1	0	1	2	2
2380	BRUMUNDDAL	HAMAR	0	0	0	1	1	1
2382	BRUMUNDDAL	HAMAR	0	0	0	1	1	1
2383	BRUMUNDDAL	HAMAR	0	0	0	1	1	1
2384	BRUMUNDDAL	HAMAR	0	1	0	0	1	1
2385	BRUMUNDDAL	HAMAR	0	1	0	0	1	1
2386	BRUMUNDDAL	HAMAR	0	1	0	0	1	1
2387	BRUMUNDDAL	HAMAR	0	1	0	0	1	1
2388	BRUMUNDDAL	HAMAR	0	1	0	0	1	1

Postcode	Place	Terminal name	Parcels*		Business parcel express		Business groupage	
			In	Out	In	Out	In	Out
2390	MOELV	HAMAR	1	1	0	1	2	2
2406	ELVERUM	HAMAR	1	1	0	1	2	2
2407	ELVERUM	HAMAR	1	1	0	1	2	2
2408	ELVERUM	HAMAR	1	1	0	1	2	2
2409	ELVERUM	HAMAR	1	1	0	1	2	2
2410	HERNES	HAMAR	1	2	0	1	4	4
2411	ELVERUM	HAMAR	1	1	0	1	2	2
2412	SØRSKOGBYGDA	HAMAR	1	2	0	1	4	4
2413	ELVERUM	HAMAR	1	1	0	1	4	4
2414	ELVERUM	HAMAR	1	1	0	1	4	4
2415	HERADSBYGD	HAMAR	1	2	0	1	4	4
2416	JØMNA	HAMAR	1	2	0	1	4	4
2420	TRYSIL	HAMAR	1	1	0	1	4	4
2422	NYBERGSUND	HAMAR	1	2	0	1	4	4
2423	ØSTBY	HAMAR	1	2	0	2	6	6
2425	LJØRDALEN	HAMAR	1	2	0	2	7	7
2427	PLASSEN	HAMAR	1	2	0	2	7	7
2428	SØRE OSEN	HAMAR	1	2	0	2	6	6
2429	TØRBERGET	HAMAR	1	2	0	2	6	6
2430	JORDET	HAMAR	1	2	0	2	7	7
2432	SLETTÅS	HAMAR	1	2	0	2	7	7
2435	BRASKEREIDFOSS	KONGSVINGER	1	2	0	2	5	5
2436	VÅLER I SOLØR	KONGSVINGER	1	2	0	1	4	4
2437	HASLEMOEN	KONGSVINGER	1	2	0	2	5	5
2438	GRAVBERGET	HAMAR	1	2	0	2	7	7

Postcode	Place	Terminal name	Parcels*		Business parcel express		Business groupage	
			In	Out	In	Out	In	Out
2440	ENGERDAL	HAMAR	1	2	0	2	7	7
2443	DREVSJØ	HAMAR	1	2	0	2	7	7
2446	ELGÅ	HAMAR	1	2	0	2	7	7
2448	SØMÅDALEN	HAMAR	1	2	0	2	8	8
2450	RENA	HAMAR	1	2	0	1	4	4
2460	OSEN	HAMAR	1	2	0	2	6	6
2476	ATNA	HAMAR	1	2	0	2	5	5
2477	SOLLIA	HAMAR	1	2	0	2	8	8
2478	HANESTAD	HAMAR	1	2	0	2	6	6
2480	KOPPANG	HAMAR	1	2	0	2	5	5
2484	RENDALEN	HAMAR	1	2	0	2	5	5
2485	RENDALEN	HAMAR	1	2	0	2	7	7
2500	TYNSET	HAMAR	1	2	0	2	5	5
2510	TYLLDALEN	HAMAR	1	2	0	2	7	7
2512	KVIKNE	HAMAR	1	2	0	2	8	8
2540	TOLGA	HAMAR	1	2	0	2	7	7
2542	VINGELEN	HAMAR	1	2	0	2	8	8
2544	ØVERSJØDALEN	HAMAR	1	2	0	2	8	8
2550	OS I ØSTERDALEN	HAMAR	1	2	0	2	8	8
2552	DALSBYGDA	HAMAR	1	2	0	2	8	8
2555	TUFSINGDALEN	HAMAR	1	2	0	2	8	8
2560	ALVDAL	HAMAR	1	2	0	2	5	5
2580	FOLLDAL	HAMAR	1	2	0	2	7	7
2582	GRIMSBU	HAMAR	1	2	0	2	7	7
2584	DALHOLEN	HAMAR	1	2	0	2	8	8

Postcode	Place	Terminal name	Parcels*		Business parcel express		Business groupage	
			In	Out	In	Out	In	Out
2607	VINGROM	HAMAR	1	2	0	1	3	3
2608	LILLEHAMMER	HAMAR	1	1	0	1	2	2
2609	LILLEHAMMER	HAMAR	1	1	0	1	2	2
2610	MESNALI	HAMAR	1	2	0	1	5	5
2611	LILLEHAMMER	HAMAR	1	1	0	1	2	2
2612	SJUSJØEN	HAMAR	1	2	0	2	5	5
2613	LILLEHAMMER	HAMAR	1	0	0	1	2	2
2614	LILLEHAMMER	HAMAR	1	1	0	1	2	2
2615	LILLEHAMMER	HAMAR	1	0	0	1	2	2
2616	LISMARKA	HAMAR	1	2	0	1	5	5
2618	LILLEHAMMER	HAMAR	1	1	0	1	2	2
2619	LILLEHAMMER	HAMAR	1	0	0	1	2	2
2624	LILLEHAMMER	HAMAR	1	1	0	1	2	2
2625	FÅBERG	HAMAR	1	1	0	1	3	3
2630	RINGEBU	OTTA	1	1	0	1	3	3
2632	VENABYGD	OTTA	1	2	0	1	4	4
2634	FÅVANG	OTTA	1	2	0	1	2	2
2635	TRETEN	HAMAR	1	1	0	1	4	4
2636	ØYER	HAMAR	1	1	0	1	4	4
2640	VINSTRÅ	OTTA	1	1	0	1	2	2
2642	KVAM	OTTA	1	2	0	1	2	2
2643	SKÅBU	OTTA	1	2	0	1	4	4
2646	GÅLÅ	OTTA	1	2	0	1	4	4
2647	SØR-FRON	OTTA	1	2	0	1	4	4
2651	ØSTRE GAUSDAL	HAMAR	1	2	0	2	5	5

Postcode	Place	Terminal name	Parcels*		Business parcel express		Business groupage	
			In	Out	In	Out	In	Out
2652	SVINGVOLL	HAMAR	1	2	0	2	5	5
2653	VESTRE GAUSDAL	HAMAR	1	2	0	2	5	5
2656	FOLLEBU	HAMAR	1	2	0	2	5	5
2657	SVATSUM	HAMAR	1	2	0	2	6	6
2658	ESPEDALEN	HAMAR	1	2	0	2	6	6
2660	DOMBÅS	OTTA	1	2	0	1	3	3
2661	HJERKINN	OTTA	1	2	0	2	6	6
2662	DOVRE	OTTA	1	2	0	1	2	2
2663	DOVRESKOGEN	OTTA	1	2	0	1	2	2
2665	LESJA	OTTA	1	2	0	2	5	5
2666	LORA	OTTA	1	2	0	2	6	6
2667	LESJAVERK	OTTA	1	2	0	2	5	5
2668	LESJASKOG	OTTA	1	2	0	2	5	5
2669	BJORLI	OTTA	1	2	0	2	6	6
2670	OTTA	OTTA	0	1	0	0	0	0
2672	SEL	OTTA	0	1	0	0	0	0
2673	HØVRINGEN	OTTA	1	2	0	1	4	4
2674	MYSUSÆTER	OTTA	1	2	0	1	3	3
2676	HEIDAL	OTTA	1	2	0	1	4	4
2677	NEDRE HEIDAL	OTTA	1	2	0	1	4	4
2680	VÅGÅ	OTTA	1	1	0	1	3	3
2682	LALM	OTTA	1	2	0	1	2	2
2683	TESSANDEN	OTTA	1	2	0	1	4	4
2685	GARMO	OTTA	1	2	0	2	5	5
2686	LOM	OTTA	1	2	0	1	3	3

Postcode	Place	Terminal name	Parcels*		Business parcel express		Business groupage	
			In	Out	In	Out	In	Out
2687	BØVERDALEN	OTTA	1	2	0	2	5	5
2690	SKJÅK	OTTA	1	2	0	2	6	6
2693	NORDBERG	OTTA	1	2	0	2	6	6
2695	GROTLI	OTTA	1	2	0	2	6	6
2720	GRINDVOLL	OSLO	1	1	0	1	4	4
2730	LUNNER	OSLO	1	1	0	1	4	4
2740	ROA	OSLO	1	1	0	1	3	3
2742	GRUA	OSLO	1	1	0	1	4	4
2743	HARESTUA	OSLO	1	1	0	1	3	3
2750	GRAN	OSLO	1	1	0	1	4	4
2760	BRANDBU	OSLO	1	1	0	2	3	3
2770	JAREN	OSLO	1	1	0	2	4	4
2815	GJØVIK	HAMAR	1	0	0	1	2	2
2816	GJØVIK	HAMAR	1	1	0	1	2	2
2817	GJØVIK	HAMAR	1	1	0	1	2	2
2818	GJØVIK	HAMAR	1	1	0	1	2	2
2819	GJØVIK	HAMAR	1	1	0	1	2	2
2820	NORDRE TOTEN	HAMAR	1	1	0	1	3	3
2821	GJØVIK	HAMAR	1	1	0	1	2	2
2822	BYBRUA	HAMAR	1	1	0	1	3	3
2825	GJØVIK	HAMAR	1	2	0	1	2	2
2827	HUNNDALEN	HAMAR	1	1	0	1	2	2
2830	RAUFOSS	HAMAR	1	1	0	1	2	2
2833	RAUFOSS	HAMAR	1	1	0	1	2	2
2834	RAUFOSS	HAMAR	1	1	0	1	2	2

Postcode	Place	Terminal name	Parcels*		Business parcel express		Business groupage	
			In	Out	In	Out	In	Out
2835	RAUFOSS	HAMAR	1	1	0	1	2	2
2836	BIRI	HAMAR	1	1	0	1	3	3
2837	BIRISTRAND	HAMAR	1	1	0	1	3	3
2838	SNERTINGDAL	HAMAR	1	2	0	1	5	5
2839	ØVRE SNERTINGDAL	HAMAR	1	2	0	2	5	5
2840	REINSVOLL	HAMAR	1	2	0	1	5	5
2843	EINA	HAMAR	1	1	0	2	3	3
2846	BØVERBRU	HAMAR	1	1	0	1	3	3
2847	KOLBU	HAMAR	1	1	0	2	3	3
2848	SKREIA	HAMAR	1	1	0	2	3	3
2849	KAPP	HAMAR	1	1	0	1	3	3
2850	LENA	HAMAR	1	1	0	1	3	3
2860	HOV	HAMAR	1	2	0	2	4	4
2861	LANDÅSBYGDA	HAMAR	1	2	0	2	5	5
2862	FLUBERG	HAMAR	1	2	0	2	3	3
2863	VESTSIDA	HAMAR	1	1	0	2	3	3
2864	FALL	HAMAR	1	1	0	2	3	3
2866	ENGER	HAMAR	1	2	0	2	6	6
2870	DOKKA	HAMAR	1	1	0	2	4	4
2879	ODNES	HAMAR	1	1	0	2	4	4
2880	NORD-TORPA	HAMAR	1	2	0	2	6	6
2881	AUST-TORPA	HAMAR	1	2	0	2	6	6
2890	ETNEDAL	HAMAR	1	2	0	2	6	6
2900	FAGERNES	HAMAR	1	1	0	2	3	3
2910	AURDAL	HAMAR	1	2	0	2	3	3

Postcode	Place	Terminal name	Parcels*		Business parcel express		Business groupage	
			In	Out	In	Out	In	Out
2917	SKRAUTVÅL	HAMAR	1	2	0	2	6	6
2918	ULNES	HAMAR	1	2	0	2	6	6
2920	LEIRA I VALDRES	HAMAR	1	1	0	2	3	3
2923	TISLEIDALEN	HAMAR	1	2	0	2	5	5
2930	BAGN	HAMAR	1	2	0	2	4	4
2933	REINLI	HAMAR	1	2	0	2	4	4
2936	BEGNADALEN	HAMAR	1	2	0	2	5	5
2937	BEGNA	HAMAR	1	2	0	2	5	5
2940	HEGGENES	HAMAR	1	2	0	2	6	6
2943	ROGNE	HAMAR	1	2	0	2	5	5
2950	SKAMMESTEIN	HAMAR	1	2	0	2	5	5
2952	BEITO	HAMAR	1	2	0	2	5	5
2953	BEITOSTØLEN	HAMAR	1	2	0	2	5	5
2960	RØN	HAMAR	1	2	0	2	6	6
2966	SLIDRE	HAMAR	1	2	0	2	6	6
2967	LOMEN	HAMAR	1	2	0	2	6	6
2973	RYFOSS	HAMAR	1	2	0	2	6	6
2975	VANG I VALDRES	HAMAR	1	2	0	2	6	6
2977	ØYE	HAMAR	1	2	0	2	5	5
2985	TYINKRYSSET	HAMAR	1	2	0	2	5	5
3004	DRAMMEN	DRAMMEN	0	0	0	1	0	0
3011	DRAMMEN	DRAMMEN	0	0	0	1	0	0
3012	DRAMMEN	DRAMMEN	0	0	0	1	0	0
3013	DRAMMEN	DRAMMEN	0	0	0	1	0	0
3014	DRAMMEN	DRAMMEN	0	1	0	1	0	0

Postcode	Place	Terminal name	Parcels*		Business parcel express		Business groupage	
			In	Out	In	Out	In	Out
3015	DRAMMEN	DRAMMEN	0	0	0	1	0	0
3016	DRAMMEN	DRAMMEN	0	0	0	1	0	0
3017	DRAMMEN	DRAMMEN	0	0	0	1	0	0
3018	DRAMMEN	DRAMMEN	0	0	0	1	0	0
3019	DRAMMEN	DRAMMEN	0	0	0	1	0	0
3021	DRAMMEN	DRAMMEN	0	1	0	1	0	0
3022	DRAMMEN	DRAMMEN	0	0	0	1	0	0
3023	DRAMMEN	DRAMMEN	0	0	0	1	0	0
3024	DRAMMEN	DRAMMEN	0	0	0	1	0	0
3025	DRAMMEN	DRAMMEN	0	0	0	1	0	0
3026	DRAMMEN	DRAMMEN	0	0	0	1	0	0
3027	DRAMMEN	DRAMMEN	0	0	0	1	0	0
3028	DRAMMEN	DRAMMEN	0	0	0	1	0	0
3029	DRAMMEN	DRAMMEN	0	0	0	1	0	0
3030	DRAMMEN	DRAMMEN	0	0	0	1	0	0
3031	DRAMMEN	DRAMMEN	0	1	0	1	0	0
3032	DRAMMEN	DRAMMEN	0	0	0	1	0	0
3033	DRAMMEN	DRAMMEN	0	0	0	1	0	0
3034	DRAMMEN	DRAMMEN	0	0	0	1	0	0
3035	DRAMMEN	DRAMMEN	0	0	0	1	0	0
3036	DRAMMEN	DRAMMEN	0	0	0	1	0	0
3037	DRAMMEN	DRAMMEN	0	1	0	1	0	0
3038	DRAMMEN	DRAMMEN	0	0	0	1	0	0
3039	DRAMMEN	DRAMMEN	0	1	0	1	0	0
3040	DRAMMEN	DRAMMEN	0	0	0	1	0	0

Postcode	Place	Terminal name	Parcels*		Business parcel express		Business groupage	
			In	Out	In	Out	In	Out
3041	DRAMMEN	DRAMMEN	0	0	0	1	0	0
3042	DRAMMEN	DRAMMEN	0	1	0	1	0	0
3043	DRAMMEN	DRAMMEN	0	0	0	1	0	0
3044	DRAMMEN	DRAMMEN	0	0	0	1	0	0
3045	DRAMMEN	DRAMMEN	0	0	0	1	0	0
3046	DRAMMEN	DRAMMEN	0	0	0	1	0	0
3047	DRAMMEN	DRAMMEN	0	0	0	1	0	0
3048	DRAMMEN	DRAMMEN	0	0	0	1	0	0
3050	MJØNDALEN	DRAMMEN	1	1	0	1	3	3
3053	STEINBERG	DRAMMEN	1	1	0	1	3	3
3055	KROKSTADELVA	DRAMMEN	1	1	0	1	2	2
3057	SOLBERGELVA	DRAMMEN	1	1	0	1	2	2
3058	SOLBERGMOEN	DRAMMEN	1	1	0	1	2	2
3060	SVELVIK	DRAMMEN	1	1	0	1	2	2
3070	SANDE I VESTFOLD	DRAMMEN	1	1	0	1	3	3
3072	SANDE I VESTFOLD	DRAMMEN	1	1	0	1	2	2
3073	SANDE I VESTFOLD	DRAMMEN	1	1	0	1	2	2
3074	SANDE I VESTFOLD	DRAMMEN	1	1	0	1	2	2
3075	BERGER	DRAMMEN	1	1	0	1	3	3
3076	SANDE I VESTFOLD	DRAMMEN	1	1	0	1	3	3
3077	SANDE I VESTFOLD	DRAMMEN	1	1	0	1	3	3
3080	HOLMESTRAND	DRAMMEN	1	1	0	1	2	2
3083	HOLMESTRAND	DRAMMEN	1	1	0	1	2	2
3084	HOLMESTRAND	DRAMMEN	1	1	0	1	2	2
3085	HOLMESTRAND	DRAMMEN	1	1	0	1	2	2

Postcode	Place	Terminal name	Parcels*		Business parcel express		Business groupage	
			In	Out	In	Out	In	Out
3086	HOLMESTRAND	DRAMMEN	1	1	0	1	2	2
3089	HOLMESTRAND	DRAMMEN	1	1	0	1	2	2
3090	HOF	DRAMMEN	1	2	0	1	5	5
3092	SUNDBYFOSS	DRAMMEN	1	2	0	1	5	5
3095	EIDSSFOSS	DRAMMEN	1	2	0	1	5	5
3110	TØNSBERG	STOKKE	0	0	0	1	1	1
3111	TØNSBERG	STOKKE	0	0	0	1	1	1
3112	TØNSBERG	STOKKE	0	0	0	1	1	1
3113	TØNSBERG	STOKKE	0	0	0	1	1	1
3114	TØNSBERG	STOKKE	0	1	0	1	1	1
3115	TØNSBERG	STOKKE	0	0	0	1	1	1
3116	TØNSBERG	STOKKE	0	0	0	1	1	1
3117	TØNSBERG	STOKKE	0	0	0	1	1	1
3118	TØNSBERG	STOKKE	0	0	0	1	1	1
3120	NØTTERØY	STOKKE	1	1	0	1	2	2
3121	NØTTERØY	STOKKE	1	1	0	1	2	2
3122	TØNSBERG	STOKKE	0	0	0	1	1	1
3123	TØNSBERG	STOKKE	0	0	0	1	1	1
3124	TØNSBERG	STOKKE	0	0	0	0	1	1
3125	TØNSBERG	STOKKE	0	0	0	1	1	1
3126	TØNSBERG	STOKKE	0	0	0	1	1	1
3127	TØNSBERG	STOKKE	0	0	0	0	1	1
3128	NØTTERØY	STOKKE	1	1	0	1	2	2
3132	HUSØYSUND	STOKKE	1	1	0	1	3	3
3133	DUKEN	STOKKE	1	1	0	1	3	3

Postcode	Place	Terminal name	Parcels*		Business parcel express		Business groupage	
			In	Out	In	Out	In	Out
3135	TORØD	STOKKE	0	1	0	0	1	1
3138	SKALLESTAD	STOKKE	0	0	0	0	1	1
3140	NØTTERØY	STOKKE	0	1	0	0	1	1
3142	VESTSKOGEN	STOKKE	0	0	0	0	1	1
3143	KJØPMANNSKJÆR	STOKKE	0	1	0	0	1	1
3144	VEIERLAND	STOKKE	1	2	0	1	2	2
3145	TJØME	STOKKE	1	1	0	1	2	2
3148	HVASSER	STOKKE	1	2	0	1	2	2
3150	TOLVSRØD	STOKKE	0	1	0	0	1	1
3151	TOLVSRØD	STOKKE	0	0	0	0	1	1
3152	TOLVSRØD	STOKKE	0	0	0	0	1	1
3153	TOLVSRØD	STOKKE	0	1	0	0	1	1
3154	TOLVSRØD	STOKKE	0	0	0	0	1	1
3157	BARKÅKER	STOKKE	0	0	0	0	1	1
3158	ANDEBU	STOKKE	0	1	0	0	1	1
3159	MELSOMVIK	STOKKE	0	1	0	0	1	1
3160	STOKKE	STOKKE	0	0	0	1	0	0
3170	SEM	STOKKE	0	0	0	0	1	1
3171	SEM	STOKKE	0	1	0	0	1	1
3172	VEAR	STOKKE	0	0	0	0	1	1
3173	VEAR	STOKKE	0	0	0	0	1	1
3174	REVELTAL	STOKKE	0	1	0	0	1	1
3175	RAMNES	STOKKE	0	1	0	0	1	1
3176	UNDRUMSDAL	STOKKE	0	1	0	0	1	1
3178	VÅLE	STOKKE	0	1	0	0	1	1

Postcode	Place	Terminal name	Parcels*		Business parcel express		Business groupage	
			In	Out	In	Out	In	Out
3179	ÅSGÅRDSTRAND	STOKKE	0	0	0	0	1	1
3180	NYKIRKE	STOKKE	0	1	0	0	1	1
3181	HORTEN	STOKKE	0	0	0	1	1	1
3182	HORTEN	STOKKE	0	0	0	1	1	1
3183	HORTEN	STOKKE	0	0	0	1	1	1
3184	BORRE	STOKKE	0	1	0	0	1	1
3185	SKOPPUM	STOKKE	0	0	0	0	1	1
3186	HORTEN	STOKKE	0	0	0	1	1	1
3187	HORTEN	STOKKE	0	0	0	1	1	1
3188	HORTEN	STOKKE	0	0	0	1	1	1
3189	HORTEN	STOKKE	0	1	0	1	1	1
3208	SANDEFJORD	STOKKE	0	0	0	1	1	1
3209	SANDEFJORD	STOKKE	0	0	0	1	1	1
3210	SANDEFJORD	STOKKE	0	0	0	1	1	1
3211	SANDEFJORD	STOKKE	0	0	0	1	1	1
3212	SANDEFJORD	STOKKE	0	0	0	1	1	1
3213	SANDEFJORD	STOKKE	0	0	0	1	1	1
3214	SANDEFJORD	STOKKE	0	0	0	1	1	1
3215	SANDEFJORD	STOKKE	0	0	0	1	1	1
3216	SANDEFJORD	STOKKE	0	0	0	1	1	1
3217	SANDEFJORD	STOKKE	0	0	0	1	1	1
3218	SANDEFJORD	STOKKE	0	0	0	1	1	1
3219	SANDEFJORD	STOKKE	0	0	0	1	1	1
3220	SANDEFJORD	STOKKE	0	1	0	1	1	1
3221	SANDEFJORD	STOKKE	0	0	0	1	1	1

Postcode	Place	Terminal name	Parcels*		Business parcel express		Business groupage	
			In	Out	In	Out	In	Out
3222	SANDEFJORD	STOKKE	0	0	0	1	1	1
3223	SANDEFJORD	STOKKE	0	0	0	1	1	1
3224	SANDEFJORD	STOKKE	0	0	0	1	1	1
3225	SANDEFJORD	STOKKE	0	0	0	1	1	1
3226	SANDEFJORD	STOKKE	0	0	0	1	1	1
3227	SANDEFJORD	STOKKE	0	0	0	1	1	1
3228	SANDEFJORD	STOKKE	0	1	0	1	1	1
3229	SANDEFJORD	STOKKE	0	0	0	1	1	1
3230	SANDEFJORD	STOKKE	0	0	0	1	1	1
3231	SANDEFJORD	STOKKE	0	1	0	1	1	1
3232	SANDEFJORD	STOKKE	0	0	0	1	1	1
3233	SANDEFJORD	STOKKE	0	1	0	0	1	1
3234	SANDEFJORD	STOKKE	0	1	0	0	1	1
3235	SANDEFJORD	STOKKE	0	0	0	1	1	1
3236	SANDEFJORD	STOKKE	0	0	0	1	1	1
3237	SANDEFJORD	STOKKE	0	1	0	0	1	1
3238	SANDEFJORD	STOKKE	0	0	0	1	1	1
3239	SANDEFJORD	STOKKE	0	1	0	0	1	1
3241	SANDEFJORD	STOKKE	0	0	0	1	1	1
3242	SANDEFJORD	STOKKE	0	1	0	1	1	1
3243	KODAL	STOKKE	0	1	0	0	1	1
3244	SANDEFJORD	STOKKE	0	0	0	1	1	1
3256	LARVIK	STOKKE	0	0	0	1	1	1
3257	LARVIK	STOKKE	0	0	0	1	1	1
3258	LARVIK	STOKKE	0	0	0	1	1	1

Postcode	Place	Terminal name	Parcels*		Business parcel express		Business groupage	
			In	Out	In	Out	In	Out
3259	LARVIK	STOKKE	0	0	0	1	1	1
3260	LARVIK	STOKKE	0	0	0	1	1	1
3261	LARVIK	STOKKE	0	1	0	1	1	1
3262	LARVIK	STOKKE	0	0	0	1	1	1
3263	LARVIK	STOKKE	0	0	0	1	1	1
3264	LARVIK	STOKKE	0	0	0	1	1	1
3265	LARVIK	STOKKE	0	0	0	0	1	1
3267	LARVIK	STOKKE	0	1	0	0	1	1
3268	LARVIK	STOKKE	0	1	0	0	1	1
3269	LARVIK	STOKKE	0	0	0	1	1	1
3270	LARVIK	STOKKE	0	1	0	0	1	1
3271	LARVIK	STOKKE	0	0	0	1	1	1
3274	LARVIK	STOKKE	0	0	0	1	1	1
3275	SVARSTAD	STOKKE	1	2	0	0	2	2
3277	STEINSHOLT	STOKKE	1	1	0	0	2	2
3280	TJODALYNG	STOKKE	0	1	0	0	1	1
3282	KVELDE	STOKKE	0	1	0	0	1	1
3290	STAVERN	STOKKE	1	1	0	1	2	2
3292	STAVERN	STOKKE	1	1	0	1	2	2
3294	STAVERN	STOKKE	1	1	0	1	2	2
3295	HELGEROA	STOKKE	1	1	0	1	2	2
3296	NEVLUNGHAVN	STOKKE	1	1	0	1	2	2
3300	HOKKSUND	DRAMMEN	1	1	0	1	3	3
3302	HOKKSUND	DRAMMEN	1	1	0	1	3	3
3303	HOKKSUND	DRAMMEN	1	1	0	1	3	3

Postcode	Place	Terminal name	Parcels*		Business parcel express		Business groupage	
			In	Out	In	Out	In	Out
3320	VESTFOSSEN	DRAMMEN	1	1	0	0	3	3
3322	FISKUM	DRAMMEN	1	2	0	1	5	5
3330	SKOTSELV	DRAMMEN	1	2	0	1	5	5
3340	ÅMOT	DRAMMEN	1	1	0	1	3	3
3350	PRESTFOSS	DRAMMEN	1	2	0	1	5	5
3355	SOLUMSMOEN	DRAMMEN	1	2	0	1	6	6
3358	NEDRE EGGEDAL	DRAMMEN	1	2	0	2	6	6
3359	EGGEDAL	DRAMMEN	1	2	0	2	6	6
3360	GEITHUS	DRAMMEN	1	2	0	1	5	5
3370	VIKERSUND	DRAMMEN	1	1	0	1	3	3
3402	LIER	DRAMMEN	0	0	0	0	1	1
3403	LIER	DRAMMEN	0	0	0	0	1	1
3404	LIER	DRAMMEN	0	1	0	0	1	1
3405	LIER	DRAMMEN	0	1	0	0	1	1
3406	TRANBY	DRAMMEN	1	1	0	0	2	2
3408	TRANBY	DRAMMEN	1	1	0	0	2	2
3409	TRANBY	DRAMMEN	1	1	0	0	2	2
3410	SYLLING	DRAMMEN	1	1	0	0	2	2
3413	LIER	DRAMMEN	0	0	0	1	1	1
3414	LIERSTRANDA	DRAMMEN	0	0	0	1	0	0
3420	LIERSKOGEN	DRAMMEN	0	0	0	0	1	1
3425	REISTAD	DRAMMEN	0	1	0	0	1	1
3426	GULLAUG	DRAMMEN	1	1	0	0	2	2
3427	GULLAUG	DRAMMEN	1	1	0	0	2	2
3430	SPIKKESTAD	DRAMMEN	1	1	0	0	3	3

Postcode	Place	Terminal name	Parcels*		Business parcel express		Business groupage	
			In	Out	In	Out	In	Out
3440	RØYKEN	DRAMMEN	1	1	0	0	3	3
3442	HYGGEN	DRAMMEN	1	2	0	1	5	5
3470	SLEMMESTAD	DRAMMEN	1	1	0	0	3	3
3472	BØDALEN	DRAMMEN	1	2	0	1	5	5
3474	ÅROS	DRAMMEN	1	1	0	0	3	3
3475	SÆTRE	DRAMMEN	1	1	0	0	4	4
3477	BÅTSTØ	DRAMMEN	1	1	0	0	4	4
3478	NÆRSNES	DRAMMEN	1	1	0	0	4	4
3480	FILTVET	DRAMMEN	1	1	0	1	4	4
3482	TOFTE	DRAMMEN	1	1	0	1	4	4
3483	KANA	DRAMMEN	1	1	0	1	4	4
3484	HOLMSBU	DRAMMEN	1	2	0	1	5	5
3490	KLOKKARSTUA	DRAMMEN	1	1	0	0	4	4
3510	HØNEFOSS	DRAMMEN	1	1	0	1	3	3
3511	HØNEFOSS	DRAMMEN	1	1	0	1	3	3
3512	HØNEFOSS	DRAMMEN	1	2	0	1	3	3
3513	HØNEFOSS	DRAMMEN	1	1	0	1	3	3
3514	HØNEFOSS	DRAMMEN	1	1	0	1	3	3
3515	HØNEFOSS	DRAMMEN	1	1	0	1	3	3
3516	HØNEFOSS	DRAMMEN	1	1	0	1	3	3
3517	HØNEFOSS	DRAMMEN	1	1	0	1	3	3
3518	HØNEFOSS	DRAMMEN	1	1	0	1	3	3
3519	HØNEFOSS	DRAMMEN	1	2	0	1	3	3
3520	JEVNAKER	DRAMMEN	1	1	0	2	4	4
3522	BJONEROA	DRAMMEN	1	2	0	2	5	5

Postcode	Place	Terminal name	Parcels*		Business parcel express		Business groupage	
			In	Out	In	Out	In	Out
3524	NES I ÅDAL	DRAMMEN	1	2	0	2	5	5
3525	HALLINGBY	DRAMMEN	1	2	0	2	4	4
3528	HEDALEN	DRAMMEN	1	2	0	2	5	5
3530	RØYSE	DRAMMEN	1	1	0	1	4	4
3531	KROKKLEIVA	DRAMMEN	1	1	0	1	3	3
3533	TYRISTRAND	DRAMMEN	1	1	0	1	4	4
3534	SOKNA	DRAMMEN	1	2	0	2	4	4
3535	KRØDEREN	DRAMMEN	1	2	0	2	5	5
3536	NORESUND	GOL	1	2	0	1	4	4
3538	SOLLIHØGDA	DRAMMEN	1	1	0	1	3	3
3539	FLÅ	GOL	1	2	0	1	4	4
3540	NESBYEN	GOL	1	1	0	1	3	3
3544	TUNHOVD	GOL	1	2	0	1	4	4
3550	GOL	GOL	0	1	0	1	0	0
3560	HEMSEDAL	GOL	1	1	0	1	3	3
3570	ÅL	GOL	1	1	0	1	3	3
3576	HOL	GOL	1	2	0	1	3	3
3577	HOVET	GOL	1	2	0	1	3	3
3579	TORPO	GOL	1	2	0	1	3	3
3580	GEILO	GOL	1	1	0	1	3	3
3588	DAGALI	GOL	1	2	0	1	4	4
3593	USTAOSSET	GOL	1	2	0	1	4	4
3595	HAUGASTØL	GOL	1	2	0	2	5	5
3608	HEISTADMOEN	DRAMMEN	1	1	0	1	3	3
3610	KONGSBERG	DRAMMEN	1	1	0	1	3	3

Postcode	Place	Terminal name	Parcels*		Business parcel express		Business groupage	
			In	Out	In	Out	In	Out
3611	KONGSBERG	DRAMMEN	1	1	0	1	3	3
3612	KONGSBERG	DRAMMEN	1	1	0	1	3	3
3613	KONGSBERG	DRAMMEN	1	0	0	1	3	3
3614	KONGSBERG	DRAMMEN	1	2	0	0	3	3
3615	KONGSBERG	DRAMMEN	1	1	0	1	3	3
3616	KONGSBERG	DRAMMEN	1	1	0	1	3	3
3617	KONGSBERG	DRAMMEN	1	0	0	1	3	3
3618	SKOLLENBORG	DRAMMEN	1	2	0	1	3	3
3619	SKOLLENBORG	DRAMMEN	1	1	0	1	3	3
3620	FLESBERG	DRAMMEN	1	2	0	1	4	4
3622	SVENE	DRAMMEN	1	2	0	1	4	4
3623	LAMPELAND	DRAMMEN	1	2	0	2	5	5
3624	LYNGDAL I NUMEDAL	DRAMMEN	1	2	0	2	5	5
3626	ROLLAG	DRAMMEN	1	2	0	2	5	5
3628	VEGLI	DRAMMEN	1	2	0	2	5	5
3629	NORE	DRAMMEN	1	2	0	2	5	5
3630	RØDBERG	DRAMMEN	1	2	0	2	5	5
3632	UVDAL	DRAMMEN	1	2	0	2	6	6
3647	HVITTINGFOSS	DRAMMEN	1	1	0	1	3	3
3648	PASSEBEKK	DRAMMEN	1	2	0	1	3	3
3650	TINN AUSTBYGD	DRAMMEN	1	2	0	2	6	6
3652	HOVIN I TELEMARK	DRAMMEN	1	2	0	2	6	6
3656	ATRÅ	DRAMMEN	1	2	0	2	6	6
3658	MILAND	DRAMMEN	1	2	0	2	6	6
3660	RJUKAN	DRAMMEN	1	2	0	2	5	5

Postcode	Place	Terminal name	Parcels*		Business parcel express		Business groupage	
			In	Out	In	Out	In	Out
3674	NOTODDEN	DRAMMEN	1	1	0	1	3	3
3675	NOTODDEN	DRAMMEN	1	1	0	2	3	3
3676	NOTODDEN	DRAMMEN	1	1	0	2	3	3
3677	NOTODDEN	DRAMMEN	1	2	0	2	3	3
3678	NOTODDEN	DRAMMEN	1	1	0	2	3	3
3679	NOTODDEN	DRAMMEN	1	1	0	2	3	3
3680	NOTODDEN	DRAMMEN	1	2	0	2	3	3
3681	NOTODDEN	DRAMMEN	1	0	0	2	3	3
3683	NOTODDEN	DRAMMEN	1	2	0	2	3	3
3684	NOTODDEN	DRAMMEN	1	1	0	2	3	3
3690	HJARTDAL	DRAMMEN	1	2	0	2	6	6
3691	GRANSHERAD	DRAMMEN	1	2	0	2	5	5
3692	SAULAND	DRAMMEN	1	2	0	2	6	6
3697	TUDDAL	DRAMMEN	1	2	0	2	6	6
3710	SKIEN	STOKKE	1	1	0	1	2	2
3711	SKIEN	STOKKE	1	1	0	1	2	2
3712	SKIEN	STOKKE	1	1	0	1	2	2
3713	SKIEN	STOKKE	1	1	0	1	2	2
3714	SKIEN	STOKKE	1	1	0	1	2	2
3715	SKIEN	STOKKE	1	0	0	1	2	2
3716	SKIEN	STOKKE	1	1	0	1	2	2
3717	SKIEN	STOKKE	1	0	0	1	2	2
3718	SKIEN	STOKKE	1	1	0	1	2	2
3719	SKIEN	STOKKE	1	1	0	0	2	2
3720	SKIEN	STOKKE	1	1	0	1	2	2

Postcode	Place	Terminal name	Parcels*		Business parcel express		Business groupage	
			In	Out	In	Out	In	Out
3721	SKIEN	STOKKE	1	2	0	1	2	2
3722	SKIEN	STOKKE	1	0	0	1	2	2
3723	SKIEN	STOKKE	1	1	0	1	2	2
3724	SKIEN	STOKKE	1	1	0	1	2	2
3725	SKIEN	STOKKE	1	1	0	1	2	2
3726	SKIEN	STOKKE	1	1	0	1	2	2
3727	SKIEN	STOKKE	1	1	0	1	2	2
3728	SKIEN	STOKKE	1	1	0	1	2	2
3729	SKIEN	STOKKE	1	2	0	1	2	2
3730	SKIEN	STOKKE	1	1	0	1	2	2
3731	SKIEN	STOKKE	1	1	0	1	2	2
3732	SKIEN	STOKKE	1	0	0	1	2	2
3733	SKIEN	STOKKE	1	1	0	1	2	2
3734	SKIEN	STOKKE	1	0	0	1	2	2
3735	SKIEN	STOKKE	1	0	0	1	2	2
3736	SKIEN	STOKKE	1	1	0	1	2	2
3737	SKIEN	STOKKE	1	1	0	1	2	2
3738	SKIEN	STOKKE	1	1	0	1	2	2
3739	SKIEN	STOKKE	1	1	0	1	2	2
3740	SKIEN	STOKKE	1	1	0	1	2	2
3741	SKIEN	STOKKE	1	1	0	1	2	2
3742	SKIEN	STOKKE	1	1	0	1	2	2
3743	SKIEN	STOKKE	1	1	0	1	2	2
3744	SKIEN	STOKKE	1	1	0	1	2	2
3746	SKIEN	STOKKE	1	1	0	1	2	2

Postcode	Place	Terminal name	Parcels*		Business parcel express		Business groupage	
			In	Out	In	Out	In	Out
3747	SKIEN	STOKKE	1	1	0	1	2	2
3748	SILJAN	STOKKE	1	2	0	1	6	6
3750	DRANGEDAL	STOKKE	1	2	0	2	6	6
3753	TØRDAL	STOKKE	1	2	0	2	7	7
3760	NESLANDSVATN	STOKKE	1	2	0	2	7	7
3766	SANNIDAL	STOKKE	1	2	0	2	5	5
3770	KRAGERØ	STOKKE	1	2	0	2	5	5
3772	KRAGERØ	STOKKE	1	2	0	2	5	5
3780	SKÅTØY	STOKKE	1	2	0	2	7	7
3781	JOMFRULAND	STOKKE	1	2	0	2	7	7
3783	KRAGERØ SKJÆRGÅRD	STOKKE	1	2	0	2	5	5
3788	STABBESTAD	STOKKE	1	2	0	2	7	7
3790	HELLE	STOKKE	1	2	0	2	6	6
3800	BØ I TELEMARK	STOKKE	1	1	0	2	4	4
3801	BØ I TELEMARK	STOKKE	1	1	0	2	4	4
3802	BØ I TELEMARK	STOKKE	1	1	0	2	4	4
3803	BØ I TELEMARK	STOKKE	1	2	0	2	4	4
3804	BØ I TELEMARK	STOKKE	1	1	0	2	4	4
3805	BØ I TELEMARK	STOKKE	1	2	0	2	4	4
3810	GVARV	STOKKE	1	2	0	2	5	5
3811	HØRTE	STOKKE	1	1	0	1	2	2
3812	AKKERHAUGEN	STOKKE	1	2	0	1	4	4
3820	NORDAGUTU	STOKKE	1	2	0	2	6	6
3825	LUNDE	STOKKE	1	2	0	1	4	4
3830	ULEFOSS	STOKKE	1	1	0	1	4	4

Postcode	Place	Terminal name	Parcels*		Business parcel express		Business groupage	
			In	Out	In	Out	In	Out
3840	SELJORD	STOKKE	1	2	0	2	5	5
3841	FLATDAL	STOKKE	1	2	0	2	7	7
3844	ÅMOTSDAL	STOKKE	1	2	0	2	7	7
3848	MORGEDAL	STOKKE	1	2	0	2	7	7
3849	VRÅLIOSEN	STOKKE	1	2	0	2	7	7
3850	KVITSEID	STOKKE	1	2	0	2	7	7
3853	VRÅDAL	STOKKE	1	2	0	2	7	7
3854	NISSEDAL	STOKKE	1	2	0	2	7	7
3855	TREUNGEN	STOKKE	1	2	0	2	7	7
3864	RAULAND	STOKKE	1	2	0	2	7	7
3870	FYRESDAL	STOKKE	1	2	0	2	7	7
3880	DALEN	STOKKE	1	2	0	2	7	7
3882	ÅMDALS VERK	STOKKE	1	2	0	2	7	7
3890	VINJE	STOKKE	1	2	0	2	7	7
3891	HØYDALSMO	STOKKE	1	2	0	2	7	7
3893	VINJESVINGEN	STOKKE	1	2	0	2	7	7
3895	EDLAND	STOKKE	1	2	0	2	7	7
3910	PORSGRUNN	STOKKE	1	1	0	1	2	2
3911	PORSGRUNN	STOKKE	1	1	0	1	2	2
3912	PORSGRUNN	STOKKE	1	0	0	1	2	2
3913	PORSGRUNN	STOKKE	1	1	0	1	2	2
3914	PORSGRUNN	STOKKE	1	1	0	1	2	2
3915	PORSGRUNN	STOKKE	1	1	0	1	2	2
3916	PORSGRUNN	STOKKE	1	0	0	1	2	2
3917	PORSGRUNN	STOKKE	1	1	0	1	2	2

Postcode	Place	Terminal name	Parcels*		Business parcel express		Business groupage	
			In	Out	In	Out	In	Out
3918	PORSGRUNN	STOKKE	1	1	0	1	2	2
3919	PORSGRUNN	STOKKE	1	0	0	1	2	2
3920	PORSGRUNN	STOKKE	1	1	0	1	2	2
3921	PORSGRUNN	STOKKE	1	1	0	1	2	2
3922	PORSGRUNN	STOKKE	1	0	0	1	2	2
3924	PORSGRUNN	STOKKE	1	1	0	1	2	2
3925	PORSGRUNN	STOKKE	1	1	0	1	2	2
3928	PORSGRUNN	STOKKE	1	1	0	1	2	2
3929	PORSGRUNN	STOKKE	1	1	0	1	2	2
3930	PORSGRUNN	STOKKE	1	1	0	1	2	2
3931	PORSGRUNN	STOKKE	1	1	0	1	2	2
3933	PORSGRUNN	STOKKE	1	1	0	1	2	2
3936	PORSGRUNN	STOKKE	1	1	0	1	2	2
3937	PORSGRUNN	STOKKE	1	1	0	1	2	2
3940	PORSGRUNN	STOKKE	1	1	0	1	2	2
3941	PORSGRUNN	STOKKE	1	1	0	1	2	2
3942	PORSGRUNN	STOKKE	1	1	0	1	2	2
3943	PORSGRUNN	STOKKE	1	1	0	1	2	2
3944	PORSGRUNN	STOKKE	1	1	0	1	2	2
3946	PORSGRUNN	STOKKE	1	1	0	1	2	2
3947	LANGANGEN	STOKKE	1	1	0	0	2	2
3948	PORSGRUNN	STOKKE	1	1	0	0	2	2
3949	PORSGRUNN	STOKKE	1	1	0	0	2	2
3950	BREVIK	STOKKE	1	1	0	1	2	2
3960	STATHELLE	STOKKE	1	1	0	1	2	2

Postcode	Place	Terminal name	Parcels*		Business parcel express		Business groupage	
			In	Out	In	Out	In	Out
3961	STATHELLE	STOKKE	1	1	0	1	2	2
3962	STATHELLE	STOKKE	1	1	0	1	2	2
3965	HERRE	STOKKE	1	1	0	1	2	2
3967	STATHELLE	STOKKE	1	2	0	2	2	2
3970	LANGESUND	STOKKE	1	1	0	1	2	2
4005	STAVANGER	STAVANGER	0	0	0	1	0	0
4006	STAVANGER	STAVANGER	0	0	0	1	0	0
4007	STAVANGER	STAVANGER	0	0	0	1	0	0
4008	STAVANGER	STAVANGER	0	0	0	1	0	0
4009	STAVANGER	STAVANGER	0	0	0	1	0	0
4010	STAVANGER	STAVANGER	0	0	0	1	0	0
4011	STAVANGER	STAVANGER	0	0	0	1	0	0
4012	STAVANGER	STAVANGER	0	0	0	1	0	0
4013	STAVANGER	STAVANGER	0	0	0	1	0	0
4014	STAVANGER	STAVANGER	0	0	0	1	0	0
4015	STAVANGER	STAVANGER	0	0	0	1	0	0
4016	STAVANGER	STAVANGER	0	0	0	1	0	0
4017	STAVANGER	STAVANGER	0	0	0	1	0	0
4018	STAVANGER	STAVANGER	0	0	0	1	0	0
4019	STAVANGER	STAVANGER	0	0	0	1	0	0
4020	STAVANGER	STAVANGER	0	0	0	1	0	0
4021	STAVANGER	STAVANGER	0	0	0	1	0	0
4022	STAVANGER	STAVANGER	0	0	0	1	0	0
4023	STAVANGER	STAVANGER	0	0	0	1	0	0
4024	STAVANGER	STAVANGER	0	0	0	1	0	0

Postcode	Place	Terminal name	Parcels*		Business parcel express		Business groupage	
			In	Out	In	Out	In	Out
4025	STAVANGER	STAVANGER	0	0	0	1	0	0
4026	STAVANGER	STAVANGER	0	0	0	1	0	0
4027	STAVANGER	STAVANGER	0	0	0	1	0	0
4028	STAVANGER	STAVANGER	0	0	0	1	0	0
4029	STAVANGER	STAVANGER	0	0	0	1	0	0
4031	STAVANGER	STAVANGER	0	0	0	1	0	0
4032	STAVANGER	STAVANGER	0	0	0	1	0	0
4033	STAVANGER	STAVANGER	0	0	0	1	0	0
4034	STAVANGER	STAVANGER	0	0	0	1	0	0
4035	STAVANGER	STAVANGER	0	0	0	1	0	0
4041	HAFRSFJORD	STAVANGER	0	0	0	1	0	0
4042	HAFRSFJORD	STAVANGER	0	0	0	1	0	0
4043	HAFRSFJORD	STAVANGER	0	0	0	1	0	0
4044	HAFRSFJORD	STAVANGER	0	0	0	1	0	0
4045	HAFRSFJORD	STAVANGER	0	0	0	1	0	0
4046	HAFRSFJORD	STAVANGER	0	0	0	1	0	0
4047	HAFRSFJORD	STAVANGER	0	1	0	1	0	0
4048	HAFRSFJORD	STAVANGER	0	0	0	1	0	0
4049	HAFRSFJORD	STAVANGER	0	0	0	1	0	0
4050	SOLA	STAVANGER	0	0	0	1	0	0
4051	SOLA	STAVANGER	0	0	0	1	0	0
4052	RØYNEBERG	STAVANGER	0	0	0	1	0	0
4053	RÆGE	STAVANGER	0	1	0	1	1	1
4054	TJELTA	STAVANGER	0	1	0	1	1	1
4055	SOLA	STAVANGER	0	1	0	1	0	0

Postcode	Place	Terminal name	Parcels*		Business parcel express		Business groupage	
			In	Out	In	Out	In	Out
4056	TANANGER	STAVANGER	0	0	0	1	0	0
4057	TANANGER	STAVANGER	0	0	0	0	0	0
4058	TANANGER	STAVANGER	0	1	0	0	0	0
4070	RANDABERG	STAVANGER	1	1	0	1	2	2
4071	RANDABERG	STAVANGER	1	1	0	1	2	2
4072	RANDABERG	STAVANGER	1	1	0	1	2	2
4073	RANDABERG	STAVANGER	1	1	0	1	2	2
4076	VASSØY	STAVANGER	1	2	0	2	5	5
4077	HUNDVÅG	STAVANGER	0	0	0	1	1	1
4083	HUNDVÅG	STAVANGER	0	0	0	1	1	1
4085	HUNDVÅG	STAVANGER	0	0	0	1	1	1
4100	JØRPELAND	STAVANGER	1	2	0	1	5	5
4102	IDSE	STAVANGER	1	2	0	2	6	6
4103	JØRPELAND	STAVANGER	1	2	0	2	6	6
4104	JØRPELAND	STAVANGER	1	2	0	2	6	6
4105	JØRPELAND	STAVANGER	1	2	0	2	6	6
4110	FORSAND	STAVANGER	1	2	0	2	6	6
4120	TAU	STAVANGER	1	2	0	1	5	5
4121	TAU	STAVANGER	1	2	0	1	5	5
4123	SØR-HIDLE	STAVANGER	1	2	0	2	6	6
4127	LYSEBOTN	STAVANGER	1	2	0	2	8	8
4128	FLØYRLI	STAVANGER	1	2	0	2	8	8
4129	SONGESAND	STAVANGER	1	2	0	2	8	8
4130	HJELMELAND	STAVANGER	1	2	0	2	5	5
4134	JØSENFJORDEN	HAUGESUND	1	2	0	2	6	6

Postcode	Place	Terminal name	Parcels*		Business parcel express		Business groupage	
			In	Out	In	Out	In	Out
4137	ÅRDAL I RYFYLKE	STAVANGER	1	2	0	2	5	5
4139	FISTER	STAVANGER	1	2	0	2	6	6
4146	SKIFTUN	HAUGESUND	1	2	0	2	6	6
4150	RENNESØY	STAVANGER	1	2	0	2	5	5
4152	VESTRE ÅMØY	STAVANGER	1	2	0	2	5	5
4153	BRIMSE	STAVANGER	1	2	0	2	6	6
4154	AUSTRE ÅMØY	STAVANGER	1	2	0	2	5	5
4156	MOSTERØY	STAVANGER	1	2	0	2	5	5
4158	BRU	STAVANGER	1	2	0	2	5	5
4160	FINNØY	STAVANGER	1	2	0	2	6	6
4163	TALGJE	STAVANGER	1	2	0	2	6	6
4164	FOGN	STAVANGER	1	2	0	2	6	6
4167	HELGØY I RYFYLKE	STAVANGER	1	2	0	2	6	6
4168	BYRE	STAVANGER	1	2	0	2	6	6
4169	SØRBOKN	STAVANGER	1	2	0	2	6	6
4170	SJERNARØY	STAVANGER	1	2	0	2	6	6
4173	NORD-HIDLE	STAVANGER	1	2	0	2	6	6
4180	KVITSØY	STAVANGER	1	2	0	2	6	6
4182	SKARTVEIT	STAVANGER	1	2	0	2	6	6
4187	OMBO	STAVANGER	1	2	0	2	6	6
4198	FOLDØY	HAUGESUND	1	2	0	2	6	6
4200	SAUDA	HAUGESUND	1	2	0	2	6	6
4208	SAUDASJØEN	HAUGESUND	1	2	0	2	6	6
4209	VANVIK	HAUGESUND	1	2	0	2	6	6
4230	SAND	HAUGESUND	1	2	0	2	6	6

Postcode	Place	Terminal name	Parcels*		Business parcel express		Business groupage	
			In	Out	In	Out	In	Out
4233	ERFJORD	HAUGESUND	1	2	0	2	6	6
4234	JELSA	HAUGESUND	1	2	0	2	6	6
4235	HEBNES	HAUGESUND	1	2	0	2	6	6
4237	SULDALSOSEN	HAUGESUND	1	2	0	2	6	6
4244	NESFLATEN	HAUGESUND	1	2	0	2	7	7
4250	KOPERVIK	HAUGESUND	1	1	0	1	4	4
4260	TORVASTAD	HAUGESUND	1	1	0	0	4	4
4262	AVALDSNES	HAUGESUND	1	1	0	1	4	4
4264	KVALAVÅG	HAUGESUND	1	1	0	0	4	4
4265	HÅVIK	HAUGESUND	1	1	0	0	3	3
4270	ÅKREHAMN	HAUGESUND	1	1	0	0	4	4
4272	SANDVE	HAUGESUND	1	1	0	0	4	4
4274	STOL	HAUGESUND	1	1	0	0	4	4
4275	SÆVELANDSVIK	HAUGESUND	1	1	0	0	4	4
4276	VEAVÅGEN	HAUGESUND	1	1	0	0	4	4
4280	SKUDENESHAVN	HAUGESUND	1	2	0	1	5	5
4306	SANDNES	STAVANGER	0	0	0	1	0	0
4307	SANDNES	STAVANGER	0	0	0	1	0	0
4308	SANDNES	STAVANGER	0	1	0	0	0	0
4309	SANDNES	STAVANGER	0	1	0	0	0	0
4310	HOMMERSÅK	STAVANGER	1	1	0	1	3	3
4311	HOMMERSÅK	STAVANGER	1	1	0	1	3	3
4312	SANDNES	STAVANGER	0	1	0	1	0	0
4313	SANDNES	STAVANGER	0	0	0	1	0	0
4314	SANDNES	STAVANGER	0	0	0	1	0	0

Postcode	Place	Terminal name	Parcels*		Business parcel express		Business groupage	
			In	Out	In	Out	In	Out
4315	SANDNES	STAVANGER	0	0	0	1	0	0
4316	SANDNES	STAVANGER	0	0	0	1	0	0
4317	SANDNES	STAVANGER	0	0	0	1	0	0
4318	SANDNES	STAVANGER	0	0	0	1	0	0
4319	SANDNES	STAVANGER	0	0	0	1	0	0
4320	SANDNES	STAVANGER	0	0	0	1	0	0
4321	SANDNES	STAVANGER	0	0	0	1	0	0
4322	SANDNES	STAVANGER	0	0	0	1	0	0
4323	SANDNES	STAVANGER	0	0	0	1	0	0
4324	SANDNES	STAVANGER	0	0	0	1	0	0
4325	SANDNES	STAVANGER	0	0	0	1	0	0
4326	SANDNES	STAVANGER	0	0	0	1	0	0
4327	SANDNES	STAVANGER	0	0	0	1	0	0
4328	SANDNES	STAVANGER	0	0	0	1	0	0
4329	SANDNES	STAVANGER	0	1	0	1	0	0
4330	ÅLGÅRD	STAVANGER	1	1	0	1	3	3
4331	ÅLGÅRD	STAVANGER	1	1	0	1	3	3
4332	FIGGJO	STAVANGER	1	1	0	1	3	3
4333	OLTEDAL	STAVANGER	1	2	0	1	5	5
4334	ÅLGÅRD	STAVANGER	1	2	0	1	5	5
4335	DIRDAL	STAVANGER	1	2	0	2	6	6
4336	SANDNES	STAVANGER	0	1	0	0	0	0
4337	SANDNES	STAVANGER	0	1	0	0	0	0
4338	SANDNES	STAVANGER	0	1	0	0	0	0
4340	BRYNE	STAVANGER	0	0	0	1	2	2

Postcode	Place	Terminal name	Parcels*		Business parcel express		Business groupage	
			In	Out	In	Out	In	Out
4341	BRYNE	STAVANGER	0	1	0	1	2	2
4342	UNDHEIM	STAVANGER	1	2	0	1	6	6
4343	ORRE	STAVANGER	1	2	0	1	5	5
4344	BRYNE	STAVANGER	0	0	0	1	2	2
4345	BRYNE	STAVANGER	0	0	0	1	1	1
4346	BRYNE	STAVANGER	0	1	0	1	1	1
4347	LYE	STAVANGER	1	1	0	0	3	3
4350	KLEPPE	STAVANGER	1	1	0	1	2	2
4351	KLEPPE	STAVANGER	1	1	0	1	2	2
4352	KLEPPE	STAVANGER	1	1	0	1	2	2
4353	KLEPP STASJON	STAVANGER	1	1	0	1	2	2
4354	VOLL	STAVANGER	1	1	0	1	3	3
4355	KVERNALAND	STAVANGER	1	1	0	1	3	3
4360	VARHAUG	STAVANGER	1	1	0	1	4	4
4362	VIGRESTAD	STAVANGER	1	1	0	1	4	4
4363	BRUSAND	STAVANGER	1	2	0	1	6	6
4364	SIREVÅG	STAVANGER	1	2	0	1	6	6
4365	NÆRBØ	STAVANGER	1	1	0	1	4	4
4370	EGERSUND	STAVANGER	1	1	0	1	3	3
4371	EGERSUND	STAVANGER	1	1	0	1	3	3
4372	EGERSUND	STAVANGER	1	1	0	1	3	3
4373	EGERSUND	STAVANGER	1	1	0	1	3	3
4374	EGERSUND	STAVANGER	1	1	0	1	3	3
4375	HELLVIK	STAVANGER	1	2	0	1	6	6
4376	HELLELAND	STAVANGER	1	2	0	1	6	6

Postcode	Place	Terminal name	Parcels*		Business parcel express		Business groupage	
			In	Out	In	Out	In	Out
4380	HAUGE I DALANE	STAVANGER	1	2	0	1	6	6
4387	BJERKREIM	STAVANGER	1	2	0	1	6	6
4389	VIKESÅ	STAVANGER	1	2	0	1	6	6
4400	FLEKKEFJORD	STAVANGER	1	1	0	1	3	3
4404	FLEKKEFJORD	STAVANGER	1	1	0	1	3	3
4405	FLEKKEFJORD	STAVANGER	1	1	0	1	3	3
4406	FLEKKEFJORD	STAVANGER	1	1	0	1	3	3
4407	FLEKKEFJORD	STAVANGER	1	1	0	1	3	3
4420	ÅNA-SIRA	STAVANGER	1	2	0	2	8	8
4432	HIDRASUND	STAVANGER	1	2	0	2	8	8
4434	ANDABELØY	STAVANGER	1	2	0	2	8	8
4436	GYLAND	STAVANGER	1	2	0	2	5	5
4438	SIRA	STAVANGER	1	2	0	2	5	5
4440	TONSTAD	STAVANGER	1	2	0	2	8	8
4443	TJØRHOM	STAVANGER	1	2	0	2	8	8
4460	MOI	STAVANGER	1	1	0	1	3	3
4462	HOVSHERAD	STAVANGER	1	2	0	2	6	6
4463	UALAND	STAVANGER	1	2	0	2	6	6
4473	KVINLOG	STAVANGER	1	2	0	2	5	5
4480	KVINESDAL	STAVANGER	1	2	0	2	5	5
4484	ØYESTRANDA	STAVANGER	1	2	0	2	5	5
4485	FEDA	STAVANGER	1	2	0	2	5	5
4513	MANDAL	KRISTIANSAND	1	1	0	1	3	3
4514	MANDAL	KRISTIANSAND	1	1	0	1	3	3
4515	MANDAL	KRISTIANSAND	1	1	0	1	3	3

Postcode	Place	Terminal name	Parcels*		Business parcel express		Business groupage	
			In	Out	In	Out	In	Out
4516	MANDAL	KRISTIANSAND	1	1	0	1	3	3
4517	MANDAL	KRISTIANSAND	1	1	0	1	3	3
4519	HOLUM	KRISTIANSAND	1	2	0	1	5	5
4520	LINDESNES	KRISTIANSAND	1	2	0	2	6	6
4521	LINDESNES	KRISTIANSAND	1	2	0	2	6	6
4525	KONSMO	KRISTIANSAND	1	2	0	2	6	6
4528	KOLLUNGVEIT	KRISTIANSAND	1	2	0	2	6	6
4529	BYREMO	KRISTIANSAND	1	2	0	2	6	6
4532	ØYSLEBØ	KRISTIANSAND	1	2	0	2	6	6
4534	MARNARDAL	KRISTIANSAND	1	2	0	2	4	4
4536	BJELLAND	KRISTIANSAND	1	2	0	2	5	5
4540	ÅSERAL	KRISTIANSAND	1	2	0	2	7	7
4544	FOSSDAL	KRISTIANSAND	1	2	0	2	6	6
4550	FARSUND	KRISTIANSAND	1	2	0	2	5	5
4560	VANSE	KRISTIANSAND	1	2	0	2	6	6
4563	BORHAUG	KRISTIANSAND	1	2	0	2	6	6
4580	LYNGDAL	KRISTIANSAND	1	1	0	1	3	3
4586	KORSHAMN	KRISTIANSAND	1	2	0	2	6	6
4588	KVÅS	KRISTIANSAND	1	2	0	2	6	6
4590	SNARTEMO	KRISTIANSAND	1	2	0	2	6	6
4595	TINGVATN	KRISTIANSAND	1	2	0	2	6	6
4596	EIKEN	KRISTIANSAND	1	2	0	2	6	6
4608	KRISTIANSAND S	KRISTIANSAND	0	0	0	1	0	0
4609	KARDEMEMOMME BY	KRISTIANSAND	0	0	0	0	0	0
4610	KRISTIANSAND S	KRISTIANSAND	0	0	0	1	0	0

Postcode	Place	Terminal name	Parcels*		Business parcel express		Business groupage	
			In	Out	In	Out	In	Out
4611	KRISTIANSAND S	KRISTIANSAND	0	0	0	1	0	0
4612	KRISTIANSAND S	KRISTIANSAND	0	0	0	1	0	0
4613	KRISTIANSAND S	KRISTIANSAND	0	0	0	1	0	0
4614	KRISTIANSAND S	KRISTIANSAND	0	0	0	1	0	0
4615	KRISTIANSAND S	KRISTIANSAND	0	1	0	1	0	0
4616	KRISTIANSAND S	KRISTIANSAND	0	0	0	1	0	0
4617	KRISTIANSAND S	KRISTIANSAND	0	1	0	1	0	0
4618	KRISTIANSAND S	KRISTIANSAND	0	1	0	1	0	0
4619	MOSBY	KRISTIANSAND	0	1	0	1	1	1
4620	KRISTIANSAND S	KRISTIANSAND	0	0	0	1	0	0
4621	KRISTIANSAND S	KRISTIANSAND	0	0	0	1	0	0
4622	KRISTIANSAND S	KRISTIANSAND	0	0	0	1	0	0
4623	KRISTIANSAND S	KRISTIANSAND	0	0	0	1	0	0
4624	KRISTIANSAND S	KRISTIANSAND	0	0	0	1	0	0
4625	FLEKKERØY	KRISTIANSAND	1	1	0	1	2	2
4626	KRISTIANSAND S	KRISTIANSAND	0	0	0	1	0	0
4628	KRISTIANSAND S	KRISTIANSAND	0	0	0	1	0	0
4629	KRISTIANSAND S	KRISTIANSAND	0	0	0	1	0	0
4630	KRISTIANSAND S	KRISTIANSAND	0	0	0	1	0	0
4631	KRISTIANSAND S	KRISTIANSAND	0	0	0	1	0	0
4632	KRISTIANSAND S	KRISTIANSAND	0	0	0	1	0	0
4633	KRISTIANSAND S	KRISTIANSAND	0	0	0	1	0	0
4634	KRISTIANSAND S	KRISTIANSAND	0	1	0	1	0	0
4635	KRISTIANSAND S	KRISTIANSAND	0	0	0	1	0	0
4636	KRISTIANSAND S	KRISTIANSAND	0	0	0	1	0	0

Postcode	Place	Terminal name	Parcels*		Business parcel express		Business groupage	
			In	Out	In	Out	In	Out
4637	KRISTIANSAND S	KRISTIANSAND	0	0	0	1	0	0
4638	KRISTIANSAND S	KRISTIANSAND	0	0	0	1	0	0
4639	KRISTIANSAND S	KRISTIANSAND	0	1	0	1	0	0
4640	SØGNE	KRISTIANSAND	1	1	0	0	2	2
4641	SØGNE	KRISTIANSAND	1	1	0	0	2	2
4642	SØGNE	KRISTIANSAND	1	1	0	0	2	2
4643	SØGNE	KRISTIANSAND	1	1	0	0	2	2
4644	SØGNE	KRISTIANSAND	1	2	0	0	2	2
4645	NODELAND	KRISTIANSAND	1	1	0	0	2	2
4646	FINSLAND	KRISTIANSAND	1	2	0	1	4	4
4647	BRENNÅSEN	KRISTIANSAND	1	1	0	0	1	1
4656	HAMRESANDEN	KRISTIANSAND	0	1	0	1	1	1
4657	KJEVIK	KRISTIANSAND	0	1	0	0	1	1
4658	TVEIT	KRISTIANSAND	1	1	0	1	2	2
4700	VENNESLA	KRISTIANSAND	0	0	0	0	1	1
4706	VENNESLA	KRISTIANSAND	0	1	0	0	3	3
4707	VENNESLA	KRISTIANSAND	0	1	0	0	3	3
4708	VENNESLA	KRISTIANSAND	0	0	0	0	3	3
4715	ØVREBØ	KRISTIANSAND	1	1	0	1	3	3
4720	HÆGELAND	KRISTIANSAND	1	2	0	1	3	3
4724	IVELAND	KRISTIANSAND	1	2	0	2	5	5
4730	VATNESTRØM	KRISTIANSAND	1	2	0	2	5	5
4735	EVJE	KRISTIANSAND	1	1	0	1	3	3
4737	HORNNES	KRISTIANSAND	1	2	0	2	3	3
4741	BYGLANDSFJORD	KRISTIANSAND	1	2	0	2	5	5

Postcode	Place	Terminal name	Parcels*		Business parcel express		Business groupage	
			In	Out	In	Out	In	Out
4742	GRENDI	KRISTIANSAND	1	2	0	2	6	6
4745	BYGLAND	KRISTIANSAND	1	2	0	2	5	5
4747	VALLE	KRISTIANSAND	1	2	0	2	7	7
4748	RYSSTAD	KRISTIANSAND	1	2	0	2	6	6
4754	BYKLE	KRISTIANSAND	1	2	0	2	7	7
4755	HOVDEN I SETESDAL	KRISTIANSAND	1	2	0	2	7	7
4760	BIRKELAND	KRISTIANSAND	1	2	0	1	2	2
4766	HEREFOSS	KRISTIANSAND	1	2	0	2	6	6
4768	ENGESLAND	KRISTIANSAND	1	2	0	2	5	5
4770	HØVÅG	KRISTIANSAND	1	1	0	1	3	3
4780	BREKKESTØ	KRISTIANSAND	1	1	0	1	3	3
4790	LILLESAND	KRISTIANSAND	1	1	0	1	2	2
4810	EYDEHAVN	KRISTIANSAND	1	1	0	1	3	3
4812	KONGSHAVN	KRISTIANSAND	1	1	0	1	3	3
4815	SALTRØD	KRISTIANSAND	1	1	0	1	3	3
4816	KOLBJØRNSVIK	KRISTIANSAND	1	1	0	1	3	3
4817	HIS	KRISTIANSAND	1	1	0	1	3	3
4818	FÆRVIK	KRISTIANSAND	1	1	0	1	3	3
4820	FROLAND	KRISTIANSAND	1	1	0	1	3	3
4821	RYKENE	KRISTIANSAND	1	1	0	1	3	3
4823	NEDENES	KRISTIANSAND	1	1	0	1	3	3
4824	BJORBekk	KRISTIANSAND	1	1	0	1	3	3
4825	ARENDAL	KRISTIANSAND	1	1	0	1	3	3
4827	FROLANDS VERK	KRISTIANSAND	1	2	0	1	3	3
4828	MJÅVATN	KRISTIANSAND	1	2	0	2	7	7

Postcode	Place	Terminal name	Parcels*		Business parcel express		Business groupage	
			In	Out	In	Out	In	Out
4830	HYNNEKLEIV	KRISTIANSAND	1	2	0	2	6	6
4832	MYKLAND	KRISTIANSAND	1	2	0	2	7	7
4834	RISDAL	KRISTIANSAND	1	2	0	2	7	7
4836	ARENDAL	KRISTIANSAND	1	0	0	1	3	3
4838	ARENDAL	KRISTIANSAND	1	0	0	1	3	3
4839	ARENDAL	KRISTIANSAND	1	1	0	1	3	3
4841	ARENDAL	KRISTIANSAND	1	1	0	1	3	3
4842	ARENDAL	KRISTIANSAND	1	1	0	1	3	3
4843	ARENDAL	KRISTIANSAND	1	1	0	1	3	3
4844	ARENDAL	KRISTIANSAND	1	1	0	1	3	3
4846	ARENDAL	KRISTIANSAND	1	1	0	1	3	3
4847	ARENDAL	KRISTIANSAND	1	1	0	1	3	3
4848	ARENDAL	KRISTIANSAND	1	1	0	1	3	3
4849	ARENDAL	KRISTIANSAND	1	1	0	1	3	3
4863	NELAUG	KRISTIANSAND	1	2	0	2	5	5
4865	ÅMLI	KRISTIANSAND	1	2	0	2	6	6
4868	SELÅSVATN	KRISTIANSAND	1	2	0	2	6	6
4869	DØLEMO	KRISTIANSAND	1	2	0	2	7	7
4870	FEVIK	KRISTIANSAND	1	1	0	1	3	3
4876	GRIMSTAD	KRISTIANSAND	1	0	0	1	3	3
4877	GRIMSTAD	KRISTIANSAND	1	1	0	1	3	3
4878	GRIMSTAD	KRISTIANSAND	1	1	0	1	3	3
4879	GRIMSTAD	KRISTIANSAND	1	1	0	1	3	3
4885	GRIMSTAD	KRISTIANSAND	1	1	0	1	3	3
4886	GRIMSTAD	KRISTIANSAND	1	1	0	1	3	3

Postcode	Place	Terminal name	Parcels*		Business parcel express		Business groupage	
			In	Out	In	Out	In	Out
4887	GRIMSTAD	KRISTIANSAND	1	1	0	1	3	3
4888	HOMBORSUND	KRISTIANSAND	1	1	0	1	3	3
4900	TVEDESTRAND	KRISTIANSAND	1	1	0	2	4	4
4903	TVEDESTRAND	KRISTIANSAND	1	1	0	2	4	4
4904	TVEDESTRAND	KRISTIANSAND	1	1	0	2	4	4
4905	TVEDESTRAND	KRISTIANSAND	1	1	0	2	4	4
4909	SONGE	KRISTIANSAND	1	2	0	2	6	6
4910	LYNGØR	KRISTIANSAND	1	2	0	2	5	5
4912	GJEVING	KRISTIANSAND	1	2	0	2	6	6
4915	VESTRE SANDØYA	KRISTIANSAND	1	2	0	2	6	6
4916	BORØY	KRISTIANSAND	1	2	0	2	6	6
4920	STAUBØ	KRISTIANSAND	1	2	0	2	6	6
4934	NES VERK	KRISTIANSAND	1	2	0	2	5	5
4950	RISØR	KRISTIANSAND	1	1	0	2	4	4
4956	RISØR	KRISTIANSAND	1	1	0	2	4	4
4957	RISØR	KRISTIANSAND	1	1	0	2	4	4
4980	GJERSTAD	KRISTIANSAND	1	2	0	2	5	5
4985	VEGÅRSHEI	KRISTIANSAND	1	2	0	2	6	6
4990	SØNDELED	KRISTIANSAND	1	2	0	2	5	5
4993	SUNDEBRU	KRISTIANSAND	1	2	0	2	5	5
4994	AKLAND	KRISTIANSAND	1	1	0	2	4	4
5003	BERGEN	BERGEN	0	0	0	1	0	0
5004	BERGEN	BERGEN	0	0	0	1	0	0
5005	BERGEN	BERGEN	0	0	0	1	0	0
5006	BERGEN	BERGEN	0	0	0	1	0	0

Postcode	Place	Terminal name	Parcels*		Business parcel express		Business groupage	
			In	Out	In	Out	In	Out
5007	BERGEN	BERGEN	0	0	0	1	0	0
5008	BERGEN	BERGEN	0	0	0	1	0	0
5009	BERGEN	BERGEN	0	0	0	1	0	0
5010	BERGEN	BERGEN	0	0	0	1	0	0
5011	BERGEN	BERGEN	0	0	0	1	0	0
5012	BERGEN	BERGEN	0	0	0	1	0	0
5013	BERGEN	BERGEN	0	0	0	1	0	0
5014	BERGEN	BERGEN	0	0	0	1	0	0
5015	BERGEN	BERGEN	0	0	0	1	0	0
5016	BERGEN	BERGEN	0	0	0	1	0	0
5017	BERGEN	BERGEN	0	1	0	1	0	0
5018	BERGEN	BERGEN	0	0	0	1	0	0
5019	BERGEN	BERGEN	0	0	0	1	0	0
5021	BERGEN	BERGEN	0	0	0	1	0	0
5022	BERGEN	BERGEN	0	0	0	1	0	0
5031	BERGEN	BERGEN	0	0	0	1	0	0
5032	BERGEN	BERGEN	0	0	0	1	0	0
5033	BERGEN	BERGEN	0	0	0	1	0	0
5034	BERGEN	BERGEN	0	0	0	1	0	0
5035	BERGEN	BERGEN	0	0	0	1	0	0
5036	BERGEN	BERGEN	0	0	0	1	0	0
5037	BERGEN	BERGEN	0	0	0	1	0	0
5038	BERGEN	BERGEN	0	0	0	1	0	0
5039	BERGEN	BERGEN	0	0	0	1	0	0
5041	BERGEN	BERGEN	0	0	0	1	0	0

Postcode	Place	Terminal name	Parcels*		Business parcel express		Business groupage	
			In	Out	In	Out	In	Out
5042	BERGEN	BERGEN	0	0	0	1	0	0
5043	BERGEN	BERGEN	0	0	0	1	0	0
5045	BERGEN	BERGEN	0	0	0	1	0	0
5052	BERGEN	BERGEN	0	0	0	1	0	0
5053	BERGEN	BERGEN	0	0	0	1	0	0
5054	BERGEN	BERGEN	0	0	0	1	0	0
5055	BERGEN	BERGEN	0	0	0	1	0	0
5056	BERGEN	BERGEN	0	0	0	1	0	0
5057	BERGEN	BERGEN	0	0	0	1	0	0
5058	BERGEN	BERGEN	0	0	0	1	0	0
5059	BERGEN	BERGEN	0	0	0	1	0	0
5063	BERGEN	BERGEN	0	0	0	1	0	0
5067	BERGEN	BERGEN	0	0	0	1	0	0
5068	BERGEN	BERGEN	0	0	0	1	0	0
5072	BERGEN	BERGEN	0	0	0	1	0	0
5073	BERGEN	BERGEN	0	0	0	1	0	0
5075	BERGEN	BERGEN	0	0	0	1	0	0
5081	BERGEN	BERGEN	0	0	0	1	0	0
5082	BERGEN	BERGEN	0	0	0	1	0	0
5089	BERGEN	BERGEN	0	0	0	1	0	0
5093	BERGEN	BERGEN	0	0	0	1	0	0
5094	BERGEN	BERGEN	0	0	0	1	0	0
5096	BERGEN	BERGEN	0	0	0	1	0	0
5097	BERGEN	BERGEN	0	0	0	1	0	0
5098	BERGEN	BERGEN	0	0	0	1	0	0

Postcode	Place	Terminal name	Parcels*		Business parcel express		Business groupage	
			In	Out	In	Out	In	Out
5099	BERGEN	BERGEN	0	0	0	1	0	0
5101	EIDSVÅGNESET	BERGEN	0	0	0	1	0	0
5104	EIDSVÅG I ÅSANE	BERGEN	0	0	0	1	0	0
5105	EIDSVÅG I ÅSANE	BERGEN	0	0	0	1	0	0
5106	ØVRE ERVIK	BERGEN	0	0	0	1	0	0
5107	SALHUS	BERGEN	0	0	0	0	0	0
5108	HORDVIK	BERGEN	0	1	0	1	0	0
5109	HYLKJE	BERGEN	0	0	0	1	0	0
5111	BREISTEIN	BERGEN	1	2	0	1	3	3
5113	TERTNES	BERGEN	0	0	0	0	0	0
5114	TERTNES	BERGEN	0	0	0	0	0	0
5115	ULSET	BERGEN	0	0	0	0	0	0
5116	ULSET	BERGEN	0	0	0	1	0	0
5117	ULSET	BERGEN	0	0	0	0	0	0
5118	ULSET	BERGEN	0	0	0	0	0	0
5119	ULSET	BERGEN	0	0	0	1	0	0
5121	ULSET	BERGEN	0	0	0	0	0	0
5122	MORVIK	BERGEN	0	0	0	0	0	0
5124	MORVIK	BERGEN	0	0	0	0	0	0
5130	NYBORG	BERGEN	0	0	0	1	0	0
5131	NYBORG	BERGEN	0	0	0	1	0	0
5132	NYBORG	BERGEN	0	0	0	1	0	0
5134	FLAKTVEIT	BERGEN	0	0	0	0	0	0
5135	FLAKTVEIT	BERGEN	0	1	0	0	0	0
5136	MJØLKERÅEN	BERGEN	0	0	0	1	0	0

Postcode	Place	Terminal name	Parcels*		Business parcel express		Business groupage	
			In	Out	In	Out	In	Out
5137	MJØLKERÅEN	BERGEN	0	1	0	0	0	0
5141	FYLLINGSDALEN	BERGEN	0	0	0	1	0	0
5142	FYLLINGSDALEN	BERGEN	0	0	0	0	0	0
5143	FYLLINGSDALEN	BERGEN	0	0	0	1	0	0
5144	FYLLINGSDALEN	BERGEN	0	0	0	0	0	0
5145	FYLLINGSDALEN	BERGEN	0	0	0	0	0	0
5146	FYLLINGSDALEN	BERGEN	0	0	0	1	0	0
5147	FYLLINGSDALEN	BERGEN	0	0	0	1	0	0
5148	FYLLINGSDALEN	BERGEN	0	0	0	0	0	0
5151	STRAUMSGREND	BERGEN	0	0	0	0	0	0
5152	BØNES	BERGEN	0	1	0	1	0	0
5153	BØNES	BERGEN	0	0	0	0	0	0
5154	BØNES	BERGEN	0	0	0	0	0	0
5155	BØNES	BERGEN	0	0	0	1	0	0
5160	LAKSEVÅG	BERGEN	0	0	0	1	0	0
5161	LAKSEVÅG	BERGEN	0	0	0	1	0	0
5162	LAKSEVÅG	BERGEN	0	0	0	1	0	0
5163	LAKSEVÅG	BERGEN	0	0	0	1	0	0
5164	LAKSEVÅG	BERGEN	0	0	0	1	0	0
5165	LAKSEVÅG	BERGEN	0	0	0	1	0	0
5170	BJØRNDALSTRÆ	BERGEN	0	0	0	0	0	0
5171	LODDEFJORD	BERGEN	0	0	0	1	0	0
5172	LODDEFJORD	BERGEN	0	0	0	0	0	0
5173	LODDEFJORD	BERGEN	0	0	0	1	0	0
5174	MATHOPEN	BERGEN	0	0	0	1	0	0

Postcode	Place	Terminal name	Parcels*		Business parcel express		Business groupage	
			In	Out	In	Out	In	Out
5176	LODDEFJORD	BERGEN	0	0	0	0	0	0
5177	BJØRØYHAMN	BERGEN	1	2	0	1	7	7
5178	LODDEFJORD	BERGEN	0	0	0	0	0	0
5179	GODVIK	BERGEN	0	0	0	1	0	0
5183	OLSVIK	BERGEN	0	0	0	0	0	0
5184	OLSVIK	BERGEN	0	0	0	0	0	0
5200	OS	BERGEN	1	0	0	1	3	3
5208	OS	BERGEN	1	1	0	1	3	3
5209	OS	BERGEN	1	1	0	1	3	3
5210	OS	BERGEN	1	1	0	1	3	3
5211	OS	BERGEN	1	1	0	2	3	3
5212	SØFTELAND	BERGEN	1	1	0	1	3	3
5215	LYSEKLOSTER	BERGEN	1	2	0	1	3	3
5216	LEPSØY	BERGEN	1	2	0	1	3	3
5217	HAGAVIK	BERGEN	1	2	0	1	3	3
5218	NORDSTRØNO	BERGEN	1	2	0	1	3	3
5221	NESTTUN	BERGEN	0	0	0	1	0	0
5222	NESTTUN	BERGEN	0	0	0	0	0	0
5223	NESTTUN	BERGEN	0	0	0	0	0	0
5224	NESTTUN	BERGEN	0	0	0	1	0	0
5225	NESTTUN	BERGEN	0	0	0	0	0	0
5226	NESTTUN	BERGEN	0	1	0	0	0	0
5227	NESTTUN	BERGEN	0	0	0	0	0	0
5228	NESTTUN	BERGEN	0	0	0	0	0	0
5229	KALANDSEIDET	BERGEN	1	1	0	1	3	3

Postcode	Place	Terminal name	Parcels*		Business parcel express		Business groupage	
			In	Out	In	Out	In	Out
5230	PARADIS	BERGEN	0	0	0	0	0	0
5231	PARADIS	BERGEN	0	0	0	0	0	0
5232	PARADIS	BERGEN	0	0	0	0	0	0
5235	RÅDAL	BERGEN	0	0	0	0	0	0
5236	RÅDAL	BERGEN	0	0	0	0	0	0
5237	RÅDAL	BERGEN	0	0	0	0	0	0
5238	RÅDAL	BERGEN	0	0	0	0	0	0
5239	RÅDAL	BERGEN	0	0	0	1	0	0
5243	FANA	BERGEN	0	1	0	0	1	1
5244	FANA	BERGEN	0	1	0	0	1	1
5251	SØREIDGREND	BERGEN	0	0	0	0	0	0
5252	SØREIDGREND	BERGEN	0	0	0	0	0	0
5253	SANDSLI	BERGEN	0	0	0	0	0	0
5254	SANDSLI	BERGEN	0	0	0	1	0	0
5257	KOKSTAD	BERGEN	0	0	0	1	0	0
5258	BLOMSTERDALEN	BERGEN	0	0	0	1	0	0
5259	HJELLESTAD	BERGEN	1	1	0	1	3	3
5260	INDRE ARNA	BERGEN	0	0	0	1	1	1
5261	INDRE ARNA	BERGEN	0	0	0	1	1	1
5262	ARNATVEIT	BERGEN	1	1	0	1	1	1
5263	TRENGEREID	BERGEN	1	2	0	1	5	5
5264	GARNES	BERGEN	1	2	0	1	5	5
5265	YTRE ARNA	BERGEN	1	1	0	0	2	2
5267	ESPELAND	BERGEN	1	1	0	0	2	2
5268	HAUKELAND	BERGEN	0	1	0	1	2	2

Postcode	Place	Terminal name	Parcels*		Business parcel express		Business groupage	
			In	Out	In	Out	In	Out
5281	VALESTRANDSFOSSEN	BERGEN	1	2	0	1	5	5
5282	LONEVÅG	BERGEN	1	2	0	1	5	5
5283	FOTLANDSVÅG	BERGEN	1	2	0	2	6	6
5284	TYSSEBOTNEN	BERGEN	1	2	0	2	6	6
5285	BRUVIK	BERGEN	1	2	0	2	6	6
5286	HAUS	BERGEN	1	2	0	2	6	6
5300	KLEPPESTØ	BERGEN	1	1	0	1	3	3
5301	KLEPPESTØ	BERGEN	1	1	0	1	3	3
5302	STRUSSHAMN	BERGEN	1	1	0	1	3	3
5303	FOLLESE	BERGEN	1	1	0	1	3	3
5304	HETLEVIK	BERGEN	1	1	0	1	3	3
5305	FLORVÅG	BERGEN	1	1	0	1	3	3
5306	ERDAL	BERGEN	1	1	0	1	3	3
5307	ASK	BERGEN	1	1	0	1	3	3
5308	KLEPPESTØ	BERGEN	1	1	0	1	3	3
5309	KLEPPESTØ	BERGEN	1	1	0	1	3	3
5310	HAUGLANDSHELLA	BERGEN	1	1	0	1	3	3
5314	KJERRGARDEN	BERGEN	1	1	0	1	3	3
5315	HERDLA	BERGEN	1	2	0	2	6	6
5334	HELLESØY	BERGEN	1	2	0	2	8	8
5335	HERNAR	BERGEN	1	2	0	2	8	8
5336	TJELDSTØ	BERGEN	1	2	0	2	7	7
5337	RONG	BERGEN	1	2	0	2	7	7
5347	ÅGOTNES	BERGEN	1	1	0	1	3	3
5350	BRATTHOLMEN	BERGEN	1	1	0	1	3	3

Postcode	Place	Terminal name	Parcels*		Business parcel express		Business groupage	
			In	Out	In	Out	In	Out
5353	STRAUME	BERGEN	1	1	0	1	3	3
5354	STRAUME	BERGEN	1	1	0	1	3	3
5355	KNARREVIK	BERGEN	1	1	0	1	3	3
5357	FJELL	BERGEN	1	1	0	1	3	3
5360	KOLLTVEIT	BERGEN	1	1	0	1	3	3
5363	ÅGOTNES	BERGEN	1	1	0	1	3	3
5365	TURØY	BERGEN	1	2	0	2	7	7
5366	MISJE	BERGEN	1	2	0	2	7	7
5378	KLOKKARVIK	BERGEN	1	2	0	2	6	6
5379	STEINSLAND	BERGEN	1	2	0	2	6	6
5380	TELAVÅG	BERGEN	1	2	0	2	6	6
5381	GLESVÆR	BERGEN	1	2	0	2	6	6
5382	SKOGSVÅG	BERGEN	1	2	0	2	6	6
5384	TORANGSVÅG	BERGEN	1	2	0	2	8	8
5385	BAKKASUND	BERGEN	1	2	0	2	8	8
5387	MØKSTER	BERGEN	1	2	0	2	8	8
5388	LITLAKALSØY	BERGEN	1	2	0	2	8	8
5392	STOREBØ	BERGEN	1	2	0	2	6	6
5394	KOLBEINSVIK	BERGEN	1	2	0	2	6	6
5396	VESTRE VINNESVÅG	BERGEN	1	2	0	2	6	6
5397	BEKKJARVIK	BERGEN	1	2	0	2	6	6
5398	STOLMEN	BERGEN	1	2	0	2	8	8
5410	SAGVÅG	HAUGESUND	1	1	0	0	3	3
5411	STORD	HAUGESUND	1	1	0	1	3	3
5412	STORD	HAUGESUND	1	1	0	1	3	3

Postcode	Place	Terminal name	Parcels*		Business parcel express		Business groupage	
			In	Out	In	Out	In	Out
5413	HUGLO	HAUGESUND	1	2	0	2	7	7
5414	STORD	HAUGESUND	1	1	0	1	3	3
5415	STORD	HAUGESUND	1	1	0	1	3	3
5416	STORD	HAUGESUND	1	1	0	1	3	3
5417	STORD	HAUGESUND	1	1	0	1	3	3
5419	FITJAR	HAUGESUND	1	2	0	2	6	6
5420	RUBBESTADNESET	HAUGESUND	1	1	0	2	4	4
5423	BRANDASUND	HAUGESUND	1	2	0	2	7	7
5427	URANGSVÅG	HAUGESUND	1	2	0	2	6	6
5428	FOLDRØYHAMN	HAUGESUND	1	2	0	2	6	6
5430	BREMNES	HAUGESUND	1	2	0	2	6	6
5437	FINNÅS	HAUGESUND	1	2	0	2	6	6
5440	MOSTERHAMN	HAUGESUND	1	2	0	2	6	6
5443	BØMLO	HAUGESUND	1	2	0	2	6	6
5444	ESPEVÆR	HAUGESUND	1	2	0	2	7	7
5450	SUNDE I SUNNHORDLAND	HAUGESUND	1	2	0	2	6	6
5451	VALEN	HAUGESUND	1	2	0	2	7	7
5452	SANDVOLL	HAUGESUND	1	2	0	2	7	7
5453	UTÅKER	HAUGESUND	1	2	0	2	7	7
5454	SÆBØVIK	HAUGESUND	1	2	0	2	7	7
5455	HALSNØY KLOSTER	HAUGESUND	1	2	0	2	7	7
5457	HØYLANDSBYGD	HAUGESUND	1	2	0	2	7	7
5458	ARNAVIK	HAUGESUND	1	2	0	2	6	6
5459	FJELBERG	HAUGESUND	1	2	0	2	7	7
5460	HUSNES	HAUGESUND	1	2	0	2	6	6

Postcode	Place	Terminal name	Parcels*		Business parcel express		Business groupage	
			In	Out	In	Out	In	Out
5462	HERØYSUNDET	HAUGESUND	1	2	0	2	7	7
5463	USKEDALEN	HAUGESUND	1	2	0	2	7	7
5464	DIMMELSVIK	HAUGESUND	1	2	0	2	7	7
5470	ROSENDAL	HAUGESUND	1	2	0	2	6	6
5472	SEIMSFLOSS	HAUGESUND	1	2	0	2	7	7
5473	SNILSTVEITØY	HAUGESUND	1	2	0	2	7	7
5474	LØFALLSTRAND	HAUGESUND	1	2	0	2	7	7
5475	ÆNES	HAUGESUND	1	2	0	2	7	7
5476	MAURANGER	HAUGESUND	1	2	0	2	7	7
5498	MATRE	HAUGESUND	1	2	0	2	4	4
5499	ÅKRA	HAUGESUND	1	2	0	2	4	4
5514	HAUGESUND	HAUGESUND	0	1	0	1	0	0
5515	HAUGESUND	HAUGESUND	0	0	0	1	0	0
5516	HAUGESUND	HAUGESUND	0	0	0	1	0	0
5517	HAUGESUND	HAUGESUND	0	0	0	1	0	0
5518	HAUGESUND	HAUGESUND	0	1	0	1	0	0
5519	HAUGESUND	HAUGESUND	0	0	0	1	0	0
5521	HAUGESUND	HAUGESUND	0	0	0	1	0	0
5522	HAUGESUND	HAUGESUND	0	0	0	1	0	0
5523	HAUGESUND	HAUGESUND	0	0	0	1	0	0
5525	HAUGESUND	HAUGESUND	0	0	0	1	0	0
5527	HAUGESUND	HAUGESUND	0	0	0	1	0	0
5528	HAUGESUND	HAUGESUND	0	0	0	1	0	0
5529	HAUGESUND	HAUGESUND	0	0	0	1	0	0
5531	HAUGESUND	HAUGESUND	0	0	0	1	0	0

Postcode	Place	Terminal name	Parcels*		Business parcel express		Business groupage	
			In	Out	In	Out	In	Out
5532	HAUGESUND	HAUGESUND	0	0	0	1	0	0
5533	HAUGESUND	HAUGESUND	0	0	0	1	0	0
5534	HAUGESUND	HAUGESUND	0	0	0	1	0	0
5535	HAUGESUND	HAUGESUND	0	0	0	1	0	0
5536	HAUGESUND	HAUGESUND	0	0	0	1	0	0
5537	HAUGESUND	HAUGESUND	0	0	0	1	0	0
5538	HAUGESUND	HAUGESUND	0	0	0	1	0	0
5541	KOLNES	HAUGESUND	1	1	0	0	3	3
5542	KARMSUND	HAUGESUND	0	0	0	1	0	0
5545	VORMEDAL	HAUGESUND	0	0	0	1	0	0
5546	RØYKSUND	HAUGESUND	1	1	0	0	4	4
5547	UTSIRA	HAUGESUND	1	2	0	2	5	5
5548	FEØY	HAUGESUND	1	2	0	2	6	6
5549	RØVÆR	HAUGESUND	1	2	0	2	6	6
5550	SVEIO	HAUGESUND	1	1	0	0	4	4
5551	AUKLANDSHAMN	HAUGESUND	1	1	0	0	4	4
5554	VALEVÅG	HAUGESUND	1	1	0	0	4	4
5555	FØRDE I HORDALAND	HAUGESUND	1	1	0	1	4	4
5560	NEDSTRAND	HAUGESUND	1	2	0	1	6	6
5561	BOKN	HAUGESUND	1	2	0	0	6	6
5563	FØRRESFJORDEN	HAUGESUND	1	1	0	0	3	3
5565	TYSVÆRVÅG	HAUGESUND	1	1	0	0	4	4
5566	HERVIK	HAUGESUND	1	2	0	0	6	6
5567	SKJOLDASTRAUMEN	HAUGESUND	1	2	0	0	6	6
5568	VIKEBYGD	HAUGESUND	1	2	0	1	4	4

Postcode	Place	Terminal name	Parcels*		Business parcel express		Business groupage	
			In	Out	In	Out	In	Out
5570	AKSDAL	HAUGESUND	1	1	0	0	4	4
5574	SKJOLD	HAUGESUND	1	1	0	0	4	4
5576	ØVRE VATS	HAUGESUND	1	1	0	0	4	4
5578	NEDRE VATS	HAUGESUND	1	2	0	1	4	4
5580	ØLEN	HAUGESUND	1	2	0	1	5	5
5582	ØLENSVÅG	HAUGESUND	1	2	0	1	5	5
5583	VIKEDAL	HAUGESUND	1	2	0	1	6	6
5584	BJOA	HAUGESUND	1	2	0	1	6	6
5585	SANDEID	HAUGESUND	1	2	0	1	5	5
5590	ETNE	HAUGESUND	1	2	0	2	6	6
5593	SKÅNEVIK	HAUGESUND	1	2	0	2	6	6
5596	MARKHUS	HAUGESUND	1	2	0	2	6	6
5598	FJÆRA	HAUGESUND	1	2	0	2	6	6
5600	NORHEIMSUND	BERGEN	1	2	0	2	5	5
5610	ØYSTESE	BERGEN	1	2	0	2	5	5
5612	STEINSTØ	BERGEN	1	2	0	2	7	7
5614	ÅLVIK	BERGEN	1	2	0	2	7	7
5620	TØRVIKBYGD	BERGEN	1	2	0	2	6	6
5626	KYSNESSTRAND	HAUGESUND	1	2	0	2	6	6
5627	JONDAL	HAUGESUND	1	2	0	2	6	6
5628	HERAND	HAUGESUND	1	2	0	2	6	6
5630	STRANDEBARM	BERGEN	1	2	0	2	6	6
5632	OMASTRAND	BERGEN	1	2	0	2	7	7
5635	HATLESTRAND	BERGEN	1	2	0	2	6	6
5636	VARALDSØY	BERGEN	1	2	0	2	8	8

Postcode	Place	Terminal name	Parcels*		Business parcel express		Business groupage	
			In	Out	In	Out	In	Out
5637	ØLVE	BERGEN	1	2	0	2	7	7
5640	EIKELANDSOSEN	BERGEN	1	2	0	2	6	6
5641	FUSA	BERGEN	1	2	0	2	6	6
5642	HOLMEFJORD	BERGEN	1	2	0	2	6	6
5643	STRANDVIK	BERGEN	1	2	0	2	7	7
5645	SÆVAREID	BERGEN	1	2	0	2	7	7
5646	NORDTVEITGREND	BERGEN	1	2	0	2	7	7
5647	BALDERSHEIM	BERGEN	1	2	0	2	7	7
5650	TYSSE	BERGEN	1	2	0	2	6	6
5652	ÅRLAND	BERGEN	1	2	0	2	6	6
5680	TYSNES	BERGEN	1	2	0	2	6	6
5683	REKSTEREN	BERGEN	1	2	0	2	8	8
5685	UGGDAL	BERGEN	1	2	0	2	6	6
5687	FLATRÅKER	BERGEN	1	2	0	2	6	6
5690	LUNDEGREND	BERGEN	1	2	0	2	6	6
5693	ÅRBAKKA	BERGEN	1	2	0	2	6	6
5694	ONARHEIM	BERGEN	1	2	0	2	6	6
5700	VOSS	BERGEN	1	2	0	2	6	6
5704	VOSS	BERGEN	1	2	0	2	6	6
5705	VOSS	BERGEN	1	1	0	2	6	6
5706	VOSS	BERGEN	1	2	0	2	6	6
5707	EVANGER	BERGEN	1	2	0	2	6	6
5708	VOSS	BERGEN	1	2	0	2	6	6
5709	VOSS	BERGEN	1	2	0	2	6	6
5710	SKULESTADMO	BERGEN	1	2	0	2	6	6

Postcode	Place	Terminal name	Parcels*		Business parcel express		Business groupage	
			In	Out	In	Out	In	Out
5713	VOSSESTRAND	BERGEN	1	2	0	2	7	7
5715	STALHEIM	BERGEN	1	2	0	2	8	8
5718	MYRDAL	BERGEN	1	2	0	2	8	8
5719	FINSE	BERGEN	1	2	0	2	8	8
5722	DALEKVAM	BERGEN	1	2	0	2	5	5
5723	BOLSTADØYRI	BERGEN	1	2	0	2	6	6
5724	STANGHELLE	BERGEN	1	2	0	2	5	5
5725	VAKSDAL	BERGEN	1	1	0	1	5	5
5727	STAMNES	BERGEN	1	2	0	2	6	6
5728	EIDSLANDET	BERGEN	1	2	0	2	8	8
5729	MODALEN	BERGEN	1	2	0	2	8	8
5730	ULVIK	BERGEN	1	2	0	2	7	7
5734	VALLAVIK	BERGEN	1	2	0	2	7	7
5736	GRANVIN	BERGEN	1	2	0	2	6	6
5743	FLÅM	BERGEN	1	2	0	2	7	7
5745	AURLAND	BERGEN	1	2	0	2	7	7
5746	UNDREDAL	BERGEN	1	2	0	2	8	8
5747	GUDVANGEN	BERGEN	1	2	0	2	7	7
5750	ODDA	HAUGESUND	1	2	0	2	5	5
5760	RØLDAL	HAUGESUND	1	2	0	2	6	6
5763	SKARE	HAUGESUND	1	2	0	2	8	8
5770	TYSSDAL	HAUGESUND	1	2	0	2	7	7
5773	HOVLAND	HAUGESUND	1	2	0	2	7	7
5776	NÅ	HAUGESUND	1	2	0	2	8	8
5777	GRIMO	HAUGESUND	1	2	0	2	7	7

Postcode	Place	Terminal name	Parcels*		Business parcel express		Business groupage	
			In	Out	In	Out	In	Out
5778	UTNE	HAUGESUND	1	2	0	2	8	8
5780	KINSARVIK	HAUGESUND	1	2	0	2	6	6
5781	LOFTHUS	HAUGESUND	1	2	0	2	6	6
5783	EIDFJORD	HAUGESUND	1	2	0	2	7	7
5784	ØVRE EIDFJORD	HAUGESUND	1	2	0	2	7	7
5785	VØRINGSFOSS	HAUGESUND	1	2	0	2	7	7
5911	ALVERSUND	BERGEN	1	2	0	2	6	6
5912	SEIM	BERGEN	1	2	0	2	6	6
5913	EIKANGERVÅG	BERGEN	1	2	0	2	6	6
5914	ISDALSTØ	BERGEN	1	1	0	1	3	3
5915	HJELMÅS	BERGEN	1	2	0	2	6	6
5916	ISDALSTØ	BERGEN	1	1	0	1	3	3
5917	ROSSLAND	BERGEN	1	2	0	2	6	6
5918	FREKHAUG	BERGEN	1	1	0	1	3	3
5919	FREKHAUG	BERGEN	1	1	0	1	3	3
5936	MANGER	BERGEN	1	2	0	2	6	6
5937	BØVÅGEN	BERGEN	1	2	0	2	6	6
5938	SÆBØVÅGEN	BERGEN	1	2	0	2	6	6
5939	SLETTA	BERGEN	1	2	0	2	6	6
5943	AUSTRHEIM	BERGEN	1	2	0	2	6	6
5947	FEDJE	BERGEN	1	2	0	2	8	8
5953	FONNES	BERGEN	1	2	0	2	6	6
5954	MONGSTAD	BERGEN	1	2	0	2	5	5
5955	LINDÅS	BERGEN	1	2	0	2	8	8
5956	HUNDVIN	BERGEN	1	2	0	2	8	8

Postcode	Place	Terminal name	Parcels*		Business parcel express		Business groupage	
			In	Out	In	Out	In	Out
5957	MYKING	BERGEN	1	2	0	2	6	6
5960	DALSØYRA	BERGEN	1	2	0	2	8	8
5961	BREKKE	BERGEN	1	2	0	2	8	8
5962	BJORDAL	BERGEN	1	2	0	2	8	8
5966	EIVINDVIK	BERGEN	1	2	0	2	8	8
5970	BYRKNESØY	BERGEN	1	2	0	2	8	8
5977	ÅNNELAND	BERGEN	1	2	0	2	8	8
5978	MJØMNA	BERGEN	1	2	0	2	8	8
5981	MASFJORDNES	BERGEN	1	2	0	2	8	8
5983	HAUGSVÆR	BERGEN	1	2	0	2	8	8
5984	MATREDAL	BERGEN	1	2	0	2	8	8
5986	HOSTELAND	BERGEN	1	2	0	2	7	7
5993	OSTEREIDET	BERGEN	1	2	0	2	6	6
5994	VIKANES	BERGEN	1	2	0	2	8	8
6002	ÅLESUND	ÅLESUND	0	0	0	1	0	0
6003	ÅLESUND	ÅLESUND	0	0	0	1	0	0
6004	ÅLESUND	ÅLESUND	0	0	0	1	0	0
6005	ÅLESUND	ÅLESUND	0	0	0	1	0	0
6006	ÅLESUND	ÅLESUND	0	0	0	1	0	0
6007	ÅLESUND	ÅLESUND	0	0	0	1	0	0
6008	ÅLESUND	ÅLESUND	0	0	0	1	0	0
6009	ÅLESUND	ÅLESUND	0	0	0	1	0	0
6010	ÅLESUND	ÅLESUND	0	1	0	1	0	0
6011	ÅLESUND	ÅLESUND	0	1	0	1	0	0
6012	ÅLESUND	ÅLESUND	0	0	0	1	0	0

Postcode	Place	Terminal name	Parcels*		Business parcel express		Business groupage	
			In	Out	In	Out	In	Out
6013	ÅLESUND	ÅLESUND	0	1	0	1	0	0
6014	ÅLESUND	ÅLESUND	0	0	0	1	0	0
6015	ÅLESUND	ÅLESUND	0	0	0	1	0	0
6016	ÅLESUND	ÅLESUND	0	0	0	1	0	0
6017	ÅLESUND	ÅLESUND	0	0	0	1	0	0
6018	ÅLESUND	ÅLESUND	0	0	0	1	0	0
6019	ÅLESUND	ÅLESUND	0	0	0	1	0	0
6020	ÅLESUND	ÅLESUND	0	0	0	1	0	0
6030	LANGEVÅG	ÅLESUND	1	1	0	1	2	2
6035	FISKARSTRAND	ÅLESUND	1	1	0	1	2	2
6036	MAUSEIDVÅG	ÅLESUND	1	1	0	1	2	2
6037	EIDSNES	ÅLESUND	0	0	0	1	0	0
6040	VIGRA	ÅLESUND	1	1	0	1	4	4
6050	VALDERØYA	ÅLESUND	1	1	0	1	3	3
6052	GISKE	ÅLESUND	1	1	0	1	4	4
6055	GODØYA	ÅLESUND	1	2	0	1	6	6
6057	ELLINGSØY	ÅLESUND	1	1	0	1	4	4
6060	HAREID	ÅLESUND	1	1	0	1	3	3
6062	BRANDAL	ÅLESUND	1	1	0	1	4	4
6063	HJØRUNGAVÅG	ÅLESUND	1	1	0	1	3	3
6064	HADDAL	ÅLESUND	1	1	0	1	4	4
6065	ULSTEINVIK	ÅLESUND	1	1	0	1	3	3
6068	EIKSUND	ÅLESUND	1	1	0	1	3	3
6070	TJØRVÅG	ÅLESUND	1	1	0	1	4	4
6076	MOLTUSTRANDA	ÅLESUND	1	1	0	1	4	4

Postcode	Place	Terminal name	Parcels*		Business parcel express		Business groupage	
			In	Out	In	Out	In	Out
6080	GURSKØY	ÅLESUND	1	1	0	1	4	4
6082	GURSKEN	ÅLESUND	1	1	0	1	4	4
6083	GJERDSVIKA	ÅLESUND	1	2	0	2	5	5
6084	LARSNES	ÅLESUND	1	2	0	2	5	5
6087	KVAMSØY	ÅLESUND	1	2	0	2	7	7
6089	SANDSHAMN	ÅLESUND	1	2	0	2	7	7
6090	FOSNAVÅG	ÅLESUND	1	1	0	1	4	4
6091	FOSNAVÅG	ÅLESUND	1	1	0	1	4	4
6092	FOSNAVÅG	ÅLESUND	1	1	0	1	4	4
6094	LEINØY	ÅLESUND	1	2	0	2	5	5
6095	BØLANDET	ÅLESUND	1	1	0	1	4	4
6096	RUNDE	ÅLESUND	1	2	0	2	7	7
6098	NERLANDSØY	ÅLESUND	1	2	0	2	5	5
6100	VOLDA	ÅLESUND	1	1	0	1	4	4
6102	VOLDA	ÅLESUND	1	1	0	1	4	4
6103	VOLDA	ÅLESUND	1	1	0	1	4	4
6104	VOLDA	ÅLESUND	1	1	0	1	4	4
6105	VOLDA	ÅLESUND	1	1	0	1	4	4
6106	VOLDA	ÅLESUND	1	2	0	1	4	4
6110	AUSTEFJORDEN	ÅLESUND	1	2	0	2	7	7
6120	FOLKESTAD	ÅLESUND	1	2	0	2	7	7
6133	LAUVSTAD	ÅLESUND	1	2	0	2	7	7
6140	SYVDE	ÅLESUND	1	2	0	2	7	7
6141	ROVDE	ÅLESUND	1	2	0	2	7	7
6142	EIDSÅ	ÅLESUND	1	2	0	2	7	7

Postcode	Place	Terminal name	Parcels*		Business parcel express		Business groupage	
			In	Out	In	Out	In	Out
6143	FISKÅ	ÅLESUND	1	2	0	2	7	7
6144	SYLTE	ÅLESUND	1	2	0	2	7	7
6146	ÅHEIM	ÅLESUND	1	2	0	2	7	7
6149	ÅRAM	ÅLESUND	1	2	0	2	7	7
6150	ØRSTA	ÅLESUND	1	1	0	1	4	4
6152	ØRSTA	ÅLESUND	1	1	0	1	4	4
6153	ØRSTA	ÅLESUND	1	1	0	1	4	4
6154	ØRSTA	ÅLESUND	1	1	0	1	4	4
6155	ØRSTA	ÅLESUND	1	1	0	1	4	4
6156	ØRSTA	ÅLESUND	1	2	0	1	4	4
6160	HOVDEBYGDA	ÅLESUND	1	1	0	1	4	4
6165	SÆBØ	ÅLESUND	1	2	0	2	7	7
6170	VARTDAL	ÅLESUND	1	2	0	1	4	4
6174	BARSTADVIK	ÅLESUND	1	2	0	1	4	4
6183	TRANDAL	ÅLESUND	1	2	0	2	8	8
6184	STORENDAL	ÅLESUND	1	2	0	2	8	8
6190	BJØRKE	ÅLESUND	1	2	0	2	7	7
6196	NORANGSFJORDEN	ÅLESUND	1	2	0	2	8	8
6200	STRANDA	ÅLESUND	1	1	0	1	4	4
6210	VALLDAL	ÅLESUND	1	2	0	1	6	6
6212	LIABYGDA	ÅLESUND	1	2	0	1	5	5
6213	TAFJORD	ÅLESUND	1	2	0	2	7	7
6214	NORDDAL	ÅLESUND	1	2	0	2	7	7
6215	EIDSDAL	ÅLESUND	1	2	0	2	7	7
6216	GEIRANGER	ÅLESUND	1	2	0	2	8	8

Postcode	Place	Terminal name	Parcels*		Business parcel express		Business groupage	
			In	Out	In	Out	In	Out
6218	HELLESYLT	ÅLESUND	1	2	0	2	6	6
6220	STRAUMGJERDE	ÅLESUND	1	2	0	1	4	4
6222	IKORNNES	ÅLESUND	1	1	0	1	4	4
6224	HUNDEIDVIK	ÅLESUND	1	2	0	2	5	5
6230	SYKKYLVEN	ÅLESUND	1	1	0	1	3	3
6240	ØRSKOG	ÅLESUND	1	1	0	1	3	3
6250	STORDAL	ÅLESUND	1	2	0	1	4	4
6260	SKODJE	ÅLESUND	0	1	0	0	0	0
6264	TENNFJORD	ÅLESUND	1	1	0	1	3	3
6265	VATNE	ÅLESUND	1	1	0	1	3	3
6270	BRATTVÅG	ÅLESUND	1	1	0	1	3	3
6272	HILDRE	ÅLESUND	1	1	0	1	4	4
6280	SØVIK	ÅLESUND	1	1	0	1	4	4
6285	STOREKALVØY	ÅLESUND	1	2	0	2	8	8
6286	ORTEN	ÅLESUND	1	2	0	2	8	8
6290	HARAMSØY	ÅLESUND	1	2	0	2	5	5
6292	KJERSTAD	ÅLESUND	1	2	0	2	7	7
6293	LONGVA	ÅLESUND	1	2	0	2	5	5
6294	FJØRTOFT	ÅLESUND	1	2	0	2	7	7
6295	MYKLEBOST	ÅLESUND	1	2	0	2	7	7
6296	HARØY	ÅLESUND	1	2	0	2	7	7
6297	SANDØY	ÅLESUND	1	2	0	2	7	7
6298	ONA	ÅLESUND	1	2	0	2	7	7
6300	ÅNDALSNES	MOLDE	1	1	0	1	3	3
6310	VEBLUNGSNES	MOLDE	1	1	0	1	3	3

Postcode	Place	Terminal name	Parcels*		Business parcel express		Business groupage	
			In	Out	In	Out	In	Out
6315	INNFJORDEN	MOLDE	1	2	0	1	3	3
6320	ISFJORDEN	MOLDE	1	2	0	1	3	3
6330	VERMA	MOLDE	1	2	0	2	7	7
6350	EIDSBYGDA	MOLDE	1	2	0	2	6	6
6360	ÅFARNES	MOLDE	1	2	0	1	3	3
6363	MITTET	MOLDE	1	2	0	2	6	6
6364	VISTDAL	MOLDE	1	2	0	2	6	6
6386	MÅNDALEN	MOLDE	1	1	0	1	3	3
6387	VÅGSTRANDA	MOLDE	1	2	0	1	3	3
6390	VESTNES	MOLDE	1	1	0	1	3	3
6391	TRESFJORD	MOLDE	1	2	0	1	3	3
6392	VIKEBUKT	MOLDE	1	2	0	1	3	3
6393	TOMREFJORD	MOLDE	1	1	0	1	3	3
6394	FIKSDAL	MOLDE	1	2	0	2	5	5
6395	REKDAL	MOLDE	1	2	0	2	6	6
6408	AUREOSEN	MOLDE	1	2	0	1	4	4
6409	MOLDE	MOLDE	0	1	0	1	0	0
6410	MOLDE	MOLDE	0	0	0	1	0	0
6411	MOLDE	MOLDE	0	1	0	1	0	0
6412	MOLDE	MOLDE	0	0	0	1	0	0
6413	MOLDE	MOLDE	0	0	0	1	0	0
6414	MOLDE	MOLDE	0	1	0	1	0	0
6415	MOLDE	MOLDE	0	0	0	1	0	0
6416	MOLDE	MOLDE	0	0	0	1	0	0
6418	SEKKEN	MOLDE	1	2	0	2	8	8

Postcode	Place	Terminal name	Parcels*		Business parcel express		Business groupage	
			In	Out	In	Out	In	Out
6419	MOLDE	MOLDE	0	0	0	1	0	0
6420	MOLDE	MOLDE	1	2	0	1	5	5
6421	MOLDE	MOLDE	0	1	0	1	0	0
6422	MOLDE	MOLDE	0	1	0	1	0	0
6423	MOLDE	MOLDE	0	0	0	1	0	0
6425	MOLDE	MOLDE	0	0	0	1	0	0
6429	MOLDE	MOLDE	0	1	0	1	0	0
6430	BUD	MOLDE	1	1	0	1	4	4
6433	HUSTAD	MOLDE	1	2	0	1	4	4
6440	ELNESVÅGEN	MOLDE	1	1	0	1	3	3
6443	TORNES I ROMSDAL	MOLDE	1	1	0	1	4	4
6444	FARSTAD	MOLDE	1	1	0	1	4	4
6445	MALMEFJORDEN	MOLDE	1	1	0	1	4	4
6450	HJELSET	MOLDE	1	1	0	0	2	2
6453	KLEIVE	MOLDE	1	2	0	0	3	3
6455	KORTGARDEN	MOLDE	1	2	0	1	5	5
6456	SKÅLA	MOLDE	1	1	0	0	4	4
6457	BOLSØYA	MOLDE	1	1	0	0	4	4
6460	EIDSVÅG I ROMSDAL	MOLDE	1	2	0	1	3	3
6462	RAUDSAND	MOLDE	1	2	0	2	5	5
6470	ERESFJORD	MOLDE	1	2	0	2	7	7
6472	EIKESDAL	MOLDE	1	2	0	2	8	8
6475	MIDSUND	MOLDE	1	2	0	2	5	5
6480	AUKRA	MOLDE	1	2	0	2	5	5
6490	EIDE	MOLDE	1	1	0	1	4	4

Postcode	Place	Terminal name	Parcels*		Business parcel express		Business groupage	
			In	Out	In	Out	In	Out
6493	LYNGSTAD	MOLDE	1	1	0	1	4	4
6494	VEVANG	MOLDE	1	1	0	1	4	4
6507	KRISTIANSUND N	MOLDE	0	0	0	1	1	1
6508	KRISTIANSUND N	MOLDE	0	0	0	1	1	1
6509	KRISTIANSUND N	MOLDE	0	1	0	1	1	1
6510	KRISTIANSUND N	MOLDE	0	0	0	1	1	1
6511	KRISTIANSUND N	MOLDE	0	0	0	1	1	1
6512	KRISTIANSUND N	MOLDE	0	0	0	1	1	1
6514	KRISTIANSUND N	MOLDE	0	0	0	1	1	1
6515	KRISTIANSUND N	MOLDE	0	0	0	1	1	1
6516	KRISTIANSUND N	MOLDE	0	0	0	1	1	1
6517	KRISTIANSUND N	MOLDE	0	0	0	1	1	1
6518	KRISTIANSUND N	MOLDE	0	0	0	1	1	1
6520	FREI	MOLDE	1	1	0	2	4	4
6521	FREI	MOLDE	1	1	0	2	4	4
6522	FREI	MOLDE	1	1	0	1	4	4
6523	FREI	MOLDE	1	1	0	1	4	4
6524	FREI	MOLDE	1	1	0	1	4	4
6525	FREI	MOLDE	1	1	0	1	4	4
6530	AVERØY	MOLDE	1	1	0	1	4	4
6531	AVERØY	MOLDE	1	1	0	1	4	4
6532	AVERØY	MOLDE	1	1	0	1	4	4
6533	AVERØY	MOLDE	1	1	0	1	4	4
6570	SMØLA	MOLDE	1	2	0	2	8	8
6590	TUSTNA	MOLDE	1	2	0	2	8	8

Postcode	Place	Terminal name	Parcels*		Business parcel express		Business groupage	
			In	Out	In	Out	In	Out
6600	SUNNDALSØRA	MOLDE	1	1	0	1	4	4
6610	ØKSENDAL	MOLDE	1	2	0	1	4	4
6611	FURUGRENDA	MOLDE	1	1	0	1	4	4
6612	GRØA	MOLDE	1	2	0	2	6	6
6613	GJØRA	MOLDE	1	2	0	2	7	7
6620	ÅLVUNDEID	MOLDE	1	2	0	2	5	5
6622	ÅLVUNDFJORD	MOLDE	1	2	0	2	5	5
6628	MEISINGSET	MOLDE	1	2	0	2	6	6
6629	TORJULVÅGEN	MOLDE	1	2	0	2	6	6
6630	TINGVOLL	MOLDE	1	2	0	2	5	5
6631	BATNFJORDSØRA	MOLDE	1	2	0	1	3	3
6633	GJEMNES	MOLDE	1	2	0	1	4	4
6636	ANGVIK	MOLDE	1	1	0	1	4	4
6637	FLEMMMA	MOLDE	1	2	0	1	4	4
6638	OSMARKA	MOLDE	1	2	0	1	4	4
6639	TORVIKBUKT	MOLDE	1	1	0	1	4	4
6640	KVANNE	MOLDE	1	2	0	2	5	5
6642	STANGVIK	MOLDE	1	2	0	2	5	5
6643	BØFJORDEN	MOLDE	1	2	0	2	5	5
6644	BÆVERFJORD	MOLDE	1	2	0	2	5	5
6645	TODALEN	MOLDE	1	2	0	2	5	5
6650	SURNADAL	MOLDE	1	2	0	2	5	5
6652	SURNADAL	MOLDE	1	2	0	2	5	5
6653	ØVRE SURNADAL	MOLDE	1	2	0	2	5	5
6655	VINDØLA	MOLDE	1	2	0	2	5	5

Postcode	Place	Terminal name	Parcels*		Business parcel express		Business groupage	
			In	Out	In	Out	In	Out
6657	RINDAL	MOLDE	1	2	0	2	5	5
6658	RINDALSSKOGEN	MOLDE	1	2	0	2	5	5
6670	ØYDEGARD	MOLDE	1	2	0	2	5	5
6674	KVISVIK	MOLDE	1	2	0	2	5	5
6680	HALSANAUSTAN	MOLDE	1	2	0	2	5	5
6683	VÅGLAND	MOLDE	1	2	0	2	5	5
6686	VALSØYBOTN	MOLDE	1	2	0	2	5	5
6687	VALSØYFJORD	MOLDE	1	2	0	2	5	5
6690	AURE	MOLDE	1	2	0	2	5	5
6693	MJOSUNDET	MOLDE	1	2	0	2	5	5
6694	FOLDFJORDEN	MOLDE	1	2	0	2	5	5
6697	VIHALS	MOLDE	1	2	0	2	5	5
6698	LESUND	MOLDE	1	2	0	2	5	5
6699	KJØRSVIKBUGEN	MOLDE	1	2	0	2	5	5
6700	MÅLØY	FØRDE	0	1	0	2	4	4
6710	RAUDEBERG	FØRDE	1	2	0	2	5	5
6711	BRYGGJA	FØRDE	1	1	0	2	4	4
6713	ALMENNINGEN	FØRDE	1	1	0	2	4	4
6714	SILDA	FØRDE	1	2	0	2	7	7
6715	BARMEN	FØRDE	1	2	0	2	7	7
6716	HUSEVÅG	FØRDE	1	2	0	2	7	7
6717	FLATRAKET	FØRDE	1	2	0	2	7	7
6718	DEKNEPOLLEN	FØRDE	1	1	0	2	4	4
6719	SKATESTRAUMEN	FØRDE	1	2	0	2	7	7
6723	SVELGEN	FØRDE	1	2	0	2	6	6

Postcode	Place	Terminal name	Parcels*		Business parcel express		Business groupage	
			In	Out	In	Out	In	Out
6727	BREMANGER	FØRDE	1	2	0	2	7	7
6729	KALVÅG	FØRDE	1	2	0	2	7	7
6730	DAVIK	FØRDE	1	2	0	2	6	6
6734	RUGSUND	FØRDE	1	2	0	2	7	7
6737	ÅLFOTEN	FØRDE	1	2	0	2	7	7
6740	SELJE	FØRDE	1	2	0	2	7	7
6750	STADLANDET	FØRDE	1	2	0	2	7	7
6763	HORNINDAL	FØRDE	1	2	0	2	3	3
6770	NORDFJORDEID	FØRDE	1	1	0	2	3	3
6773	NORDFJORDEID	FØRDE	1	1	0	2	3	3
6774	NORDFJORDEID	FØRDE	1	1	0	2	3	3
6776	KJØLSDALEN	FØRDE	1	2	0	2	4	4
6777	STÅRHEIM	FØRDE	1	1	0	2	4	4
6778	LOTE	FØRDE	1	2	0	2	3	3
6779	HOLMØYANE	FØRDE	1	2	0	2	3	3
6783	STRYN	FØRDE	0	1	0	0	2	2
6788	OLDEN	FØRDE	1	2	0	2	3	3
6789	LOEN	FØRDE	1	2	0	2	3	3
6791	OLDEDALEN	FØRDE	1	2	0	2	4	4
6792	BRIKSDALSBRE	FØRDE	1	2	0	2	4	4
6793	INNVIK	FØRDE	1	2	0	2	2	2
6795	BLAKSÆTER	FØRDE	1	2	0	2	4	4
6796	HOPLAND	FØRDE	1	2	0	2	4	4
6797	UTVIK	FØRDE	1	2	0	2	2	2
6798	HJELLEDALEN	FØRDE	1	2	0	2	4	4

Postcode	Place	Terminal name	Parcels*		Business parcel express		Business groupage	
			In	Out	In	Out	In	Out
6799	OPPSTRYN	FØRDE	1	2	0	2	4	4
6800	FØRDE	FØRDE	0	0	0	1	0	0
6809	FØRDE	FØRDE	0	0	0	1	0	0
6810	FØRDE	FØRDE	0	1	0	0	0	0
6811	FØRDE	FØRDE	0	2	0	1	0	0
6812	FØRDE	FØRDE	0	0	0	1	0	0
6813	FØRDE	FØRDE	0	0	0	1	0	0
6814	FØRDE	FØRDE	0	1	0	1	0	0
6815	FØRDE	FØRDE	0	1	0	1	0	0
6817	NAUSTDAL	FØRDE	1	2	0	1	3	3
6818	HAUKEDALEN	FØRDE	1	2	0	2	6	6
6819	FØRDE	FØRDE	0	1	0	0	0	0
6823	SANDANE	FØRDE	1	1	0	1	2	2
6826	BYRKJELO	FØRDE	1	2	0	2	2	2
6827	BREIM	FØRDE	1	2	0	2	2	2
6828	HESTENESØYRA	FØRDE	1	2	0	2	4	4
6829	HYEN	FØRDE	1	2	0	2	4	4
6843	SKEI I JØLSTER	FØRDE	1	2	0	2	3	3
6847	VASSENDEN	FØRDE	1	2	0	1	2	2
6848	FJÆRLAND	FØRDE	1	2	0	2	5	5
6854	KAUPANGER	FØRDE	0	1	0	1	2	2
6855	FRØNNINGEN	FØRDE	1	2	0	2	7	7
6856	SOGNDAL	FØRDE	0	1	0	1	2	2
6857	SOGNDAL	FØRDE	0	0	0	1	2	2
6858	FARDAL	FØRDE	0	1	0	0	3	3

Postcode	Place	Terminal name	Parcels*		Business parcel express		Business groupage	
			In	Out	In	Out	In	Out
6859	SLINDA	FØRDE	1	1	0	1	3	3
6863	LEIKANGER	FØRDE	1	1	0	1	3	3
6868	GAUPNE	FØRDE	1	1	0	1	4	4
6869	HAFSLO	FØRDE	1	1	0	1	3	3
6870	ORNES	FØRDE	1	2	0	2	7	7
6871	JOSTEDAL	FØRDE	1	2	0	2	7	7
6872	LUSTER	FØRDE	1	2	0	1	4	4
6873	MARIFJØRA	FØRDE	1	1	0	1	4	4
6875	HØYHEIMSVIK	FØRDE	1	1	0	1	4	4
6876	SKJOLDEN	FØRDE	1	2	0	2	5	5
6877	FORTUN	FØRDE	1	2	0	2	5	5
6878	VEITASTROND	FØRDE	1	2	0	2	7	7
6879	SOLVORN	FØRDE	1	1	0	2	4	4
6884	ØVRE ÅRDAL	FØRDE	1	1	0	1	4	4
6885	ÅRDALSTANGEN	FØRDE	1	1	0	1	4	4
6887	LÆRDAL	FØRDE	1	2	0	1	3	3
6888	BORGUND	FØRDE	1	2	0	2	5	5
6893	VIK I SOGN	FØRDE	1	2	0	2	4	4
6894	VANGSNES	FØRDE	1	1	0	2	4	4
6895	FEIOS	FØRDE	1	2	0	2	4	4
6896	FRESVIK	FØRDE	1	2	0	2	4	4
6899	BALESTRAND	FØRDE	1	2	0	2	4	4
6900	FLORØ	FØRDE	1	1	0	1	3	3
6905	FLORØ	FØRDE	1	1	0	1	3	3
6906	FLORØ	FØRDE	1	1	0	1	3	3

Postcode	Place	Terminal name	Parcels*		Business parcel express		Business groupage	
			In	Out	In	Out	In	Out
6907	FLORØ	FØRDE	1	1	0	1	3	3
6908	FLORØ	FØRDE	1	1	0	1	3	3
6910	FLORØ	FØRDE	1	1	0	1	3	3
6912	KINN	FØRDE	1	2	0	2	8	8
6913	FLORØ	FØRDE	1	1	0	2	3	3
6914	SVANØYBUKT	FØRDE	1	2	0	2	8	8
6915	ROGNALDSVÅG	FØRDE	1	2	0	2	8	8
6916	BAREKSTAD	FØRDE	1	2	0	2	8	8
6917	BATALDEN	FØRDE	1	2	0	2	8	8
6918	SØR-SKORPA	FØRDE	1	2	0	2	8	8
6919	TANSØY	FØRDE	1	2	0	2	8	8
6924	HARDBAKKE	FØRDE	1	2	0	2	8	8
6926	KRAKHELLA	FØRDE	1	2	0	2	8	8
6927	YTRØYGREND	FØRDE	1	2	0	2	8	8
6928	KOLGROV	FØRDE	1	2	0	2	8	8
6929	HERSVIKBYGDA	FØRDE	1	2	0	2	8	8
6940	EIKEFJORD	FØRDE	1	2	0	1	4	4
6942	SVORTEVIK	FØRDE	1	2	0	2	4	4
6944	STAVANG	FØRDE	1	2	0	2	6	6
6947	LAVIK	FØRDE	1	2	0	1	4	4
6953	LEIRVIK I SOGN	FØRDE	1	2	0	1	4	4
6957	HYLLESTAD	FØRDE	1	1	0	1	4	4
6958	SØRBØVÅG	FØRDE	1	2	0	1	4	4
6963	DALE I SUNNFJORD	FØRDE	1	1	0	1	4	4
6964	KORSSUND	FØRDE	1	2	0	2	5	5

Postcode	Place	Terminal name	Parcels*		Business parcel express		Business groupage	
			In	Out	In	Out	In	Out
6966	GUDDAL	FØRDE	1	2	0	2	5	5
6967	HELLEVIK I FJALER	FØRDE	1	1	0	1	4	4
6968	FLEKKE	FØRDE	1	2	0	1	4	4
6969	STRAUMSNES	FØRDE	1	1	0	1	4	4
6973	SANDE I SUNNFJORD	FØRDE	1	2	0	1	3	3
6975	SKILBREI	FØRDE	1	1	0	1	3	3
6977	BYGSTAD	FØRDE	1	2	0	1	3	3
6978	VIKSDALEN	FØRDE	1	2	0	2	3	3
6980	ASKVOLL	FØRDE	1	1	0	1	4	4
6982	HOLMEDAL	FØRDE	1	2	0	1	4	4
6983	KVAMMEN	FØRDE	1	2	0	2	7	7
6984	STONGFJORDEN	FØRDE	1	2	0	1	4	4
6985	ATLØY	FØRDE	1	2	0	2	8	8
6986	VÆRLANDET	FØRDE	1	2	0	2	8	8
6987	BULANDET	FØRDE	1	2	0	2	8	8
6993	HØYANGER	FØRDE	1	2	0	2	4	4
6994	NESSANE	FØRDE	1	2	0	2	5	5
6995	KYRKJEBØ	FØRDE	1	2	0	2	5	5
6996	VADHEIM	FØRDE	1	2	0	1	4	4
7010	TRONDHEIM	TRONDHEIM	0	0	0	1	0	0
7011	TRONDHEIM	TRONDHEIM	0	0	0	1	0	0
7012	TRONDHEIM	TRONDHEIM	0	0	0	1	0	0
7013	TRONDHEIM	TRONDHEIM	0	0	0	1	0	0
7014	TRONDHEIM	TRONDHEIM	0	0	0	1	0	0
7015	TRONDHEIM	TRONDHEIM	0	0	0	1	0	0

Postcode	Place	Terminal name	Parcels*		Business parcel express		Business groupage	
			In	Out	In	Out	In	Out
7016	TRONDHEIM	TRONDHEIM	0	0	0	1	0	0
7017	TRONDHEIM	TRONDHEIM	0	0	0	1	0	0
7018	TRONDHEIM	TRONDHEIM	0	1	0	1	0	0
7019	TRONDHEIM	TRONDHEIM	0	0	0	1	0	0
7020	TRONDHEIM	TRONDHEIM	0	1	0	1	0	0
7021	TRONDHEIM	TRONDHEIM	0	0	0	1	0	0
7022	TRONDHEIM	TRONDHEIM	0	0	0	1	0	0
7023	TRONDHEIM	TRONDHEIM	0	0	0	1	0	0
7024	TRONDHEIM	TRONDHEIM	0	1	0	1	0	0
7025	TRONDHEIM	TRONDHEIM	0	0	0	1	0	0
7026	TRONDHEIM	TRONDHEIM	0	1	0	1	0	0
7027	TRONDHEIM	TRONDHEIM	0	0	0	1	0	0
7028	TRONDHEIM	TRONDHEIM	0	0	0	1	0	0
7029	TRONDHEIM	TRONDHEIM	0	0	0	1	0	0
7030	TRONDHEIM	TRONDHEIM	0	0	0	1	0	0
7031	TRONDHEIM	TRONDHEIM	0	0	0	1	0	0
7032	TRONDHEIM	TRONDHEIM	0	0	0	1	0	0
7033	TRONDHEIM	TRONDHEIM	0	0	0	1	0	0
7034	TRONDHEIM	TRONDHEIM	0	0	0	1	0	0
7035	TRONDHEIM	TRONDHEIM	0	0	0	1	0	0
7036	TRONDHEIM	TRONDHEIM	0	0	0	1	0	0
7037	TRONDHEIM	TRONDHEIM	0	0	0	1	0	0
7038	TRONDHEIM	TRONDHEIM	0	0	0	1	0	0
7039	TRONDHEIM	TRONDHEIM	0	2	0	1	0	0
7040	TRONDHEIM	TRONDHEIM	0	1	0	1	0	0

Postcode	Place	Terminal name	Parcels*		Business parcel express		Business groupage	
			In	Out	In	Out	In	Out
7041	TRONDHEIM	TRONDHEIM	0	0	0	1	0	0
7042	TRONDHEIM	TRONDHEIM	0	0	0	1	0	0
7043	TRONDHEIM	TRONDHEIM	0	0	0	1	0	0
7044	TRONDHEIM	TRONDHEIM	0	0	0	1	0	0
7045	TRONDHEIM	TRONDHEIM	0	0	0	1	0	0
7046	TRONDHEIM	TRONDHEIM	0	0	0	1	0	0
7047	TRONDHEIM	TRONDHEIM	0	0	0	1	0	0
7048	TRONDHEIM	TRONDHEIM	0	0	0	1	0	0
7049	TRONDHEIM	TRONDHEIM	0	0	0	1	0	0
7050	TRONDHEIM	TRONDHEIM	0	0	0	1	0	0
7051	TRONDHEIM	TRONDHEIM	0	0	0	1	0	0
7052	TRONDHEIM	TRONDHEIM	0	0	0	1	0	0
7053	RANHEIM	TRONDHEIM	0	0	0	1	0	0
7054	RANHEIM	TRONDHEIM	0	0	0	1	0	0
7055	RANHEIM	TRONDHEIM	0	1	0	1	0	0
7056	RANHEIM	TRONDHEIM	0	0	0	1	0	0
7057	JONSVATNET	TRONDHEIM	1	1	0	1	2	2
7058	CHARLOTTENLUND	TRONDHEIM	0	0	0	1	0	0
7059	JAKOBSLI	TRONDHEIM	0	0	0	1	0	0
7060	CHARLOTTENLUND	TRONDHEIM	0	0	0	1	0	0
7066	TRONDHEIM	TRONDHEIM	0	0	0	1	0	0
7067	TRONDHEIM	TRONDHEIM	0	0	0	1	0	0
7068	TRONDHEIM	TRONDHEIM	0	0	0	1	0	0
7069	TRONDHEIM	TRONDHEIM	0	0	0	1	0	0
7070	BOSBERG	TRONDHEIM	1	1	0	1	2	2

Postcode	Place	Terminal name	Parcels*		Business parcel express		Business groupage	
			In	Out	In	Out	In	Out
7071	TRONDHEIM	TRONDHEIM	0	0	0	1	0	0
7072	HEIMDAL	TRONDHEIM	0	0	0	1	0	0
7074	SPONGDAL	TRONDHEIM	1	1	0	1	3	3
7075	TILLER	TRONDHEIM	0	0	0	1	0	0
7078	SAUPSTAD	TRONDHEIM	0	0	0	1	0	0
7079	FLATÅSEN	TRONDHEIM	0	0	0	1	0	0
7080	HEIMDAL	TRONDHEIM	0	0	0	1	0	0
7081	SJETNEMARKA	TRONDHEIM	0	0	0	1	0	0
7082	KATTEM	TRONDHEIM	0	0	0	1	0	0
7083	LEINSTRAND	TRONDHEIM	1	1	0	0	3	3
7088	HEIMDAL	TRONDHEIM	0	0	0	1	0	0
7089	HEIMDAL	TRONDHEIM	0	1	0	0	0	0
7091	TILLER	TRONDHEIM	0	0	0	1	0	0
7092	TILLER	TRONDHEIM	0	1	0	1	0	0
7093	TILLER	TRONDHEIM	0	0	0	1	0	0
7097	SAUPSTAD	TRONDHEIM	0	0	0	1	0	0
7098	SAUPSTAD	TRONDHEIM	0	0	0	1	0	0
7099	FLATÅSEN	TRONDHEIM	0	0	0	1	0	0
7100	RISSA	TRONDHEIM	1	2	0	2	6	6
7105	STADSBYGD	TRONDHEIM	1	2	0	2	6	6
7110	FEVÅG	TRONDHEIM	1	2	0	2	6	6
7112	HASSELVIKA	TRONDHEIM	1	2	0	2	6	6
7113	HUSBYSJØEN	TRONDHEIM	1	2	0	2	6	6
7114	RÅKVÅG	TRONDHEIM	1	2	0	2	6	6
7120	LEKSVIK	TRONDHEIM	1	2	0	2	6	6

Postcode	Place	Terminal name	Parcels*		Business parcel express		Business groupage	
			In	Out	In	Out	In	Out
7125	VANVIKAN	TRONDHEIM	1	2	0	2	6	6
7130	BREKSTAD	TRONDHEIM	1	2	0	2	7	7
7140	OPPHAUG	TRONDHEIM	1	2	0	2	7	7
7142	UTHAUG	TRONDHEIM	1	2	0	2	7	7
7150	STORFOSNA	TRONDHEIM	1	2	0	2	7	7
7152	KRÅKVÅG	TRONDHEIM	1	2	0	2	7	7
7153	GARTEN	TRONDHEIM	1	2	0	2	7	7
7156	LEKSA	TRONDHEIM	1	2	0	2	7	7
7160	BJUGN	TRONDHEIM	1	2	0	2	7	7
7165	OKSVOLL	TRONDHEIM	1	2	0	2	7	7
7166	TARVA	TRONDHEIM	1	2	0	2	7	7
7167	VALLERSUND	TRONDHEIM	1	2	0	2	7	7
7168	LYSØYSUNDET	TRONDHEIM	1	2	0	2	7	7
7170	ÅFJORD	TRONDHEIM	1	2	0	2	7	7
7176	LINESØYA	TRONDHEIM	1	2	0	2	7	7
7177	REVSNES	TRONDHEIM	1	2	0	2	7	7
7178	STOKKØY	TRONDHEIM	1	2	0	2	7	7
7180	ROAN	TRONDHEIM	1	2	0	2	7	7
7190	BESSAKER	TRONDHEIM	1	2	0	2	7	7
7194	BRANDSFJORD	TRONDHEIM	1	2	0	2	7	7
7200	KYRKSÆTERØRA	TRONDHEIM	1	2	0	2	5	5
7203	VINJEØRA	TRONDHEIM	1	2	0	2	8	8
7206	HELLANDSJØEN	TRONDHEIM	1	2	0	2	8	8
7207	YTRE SNILLFJORD	TRONDHEIM	1	2	0	2	8	8
7212	KORSVEGEN	TRONDHEIM	1	2	0	2	7	7

Postcode	Place	Terminal name	Parcels*		Business parcel express		Business groupage	
			In	Out	In	Out	In	Out
7213	GÅSBAKKEN	TRONDHEIM	1	2	0	2	7	7
7224	MELHUS	TRONDHEIM	1	1	0	1	2	2
7227	GIMSE	TRONDHEIM	1	2	0	1	6	6
7228	KVÅL	TRONDHEIM	1	1	0	0	3	3
7232	LUNDAMO	TRONDHEIM	1	2	0	0	3	3
7234	LER	TRONDHEIM	1	1	0	0	3	3
7236	HOVIN I GAULDAL	TRONDHEIM	1	2	0	0	4	4
7240	HITRA	TRONDHEIM	1	2	0	2	8	8
7241	ANSNES	TRONDHEIM	1	2	0	2	8	8
7242	KNARRLAGSUND	TRONDHEIM	1	2	0	2	8	8
7243	KVENVÆR	TRONDHEIM	1	2	0	2	8	8
7246	SANDSTAD	TRONDHEIM	1	2	0	2	8	8
7247	HESTVIKA	TRONDHEIM	1	2	0	2	8	8
7250	MELANDSJØ	TRONDHEIM	1	2	0	2	8	8
7252	DOLMØY	TRONDHEIM	1	2	0	2	8	8
7255	SUNDLANDET	TRONDHEIM	1	2	0	2	7	7
7256	HEMNSKJELA	TRONDHEIM	1	2	0	2	7	7
7257	SNILLFJORD	TRONDHEIM	1	2	0	2	7	7
7260	SISTRANDA	TRONDHEIM	1	2	0	2	8	8
7263	HAMARVIK	TRONDHEIM	1	2	0	2	8	8
7266	KVERVA	TRONDHEIM	1	2	0	2	8	8
7268	TITRAN	TRONDHEIM	1	2	0	2	8	8
7270	DYRVIK	TRONDHEIM	1	2	0	2	8	8
7273	NORDDYRØY	TRONDHEIM	1	2	0	2	8	8
7280	SULA	TRONDHEIM	1	2	0	2	8	8

Postcode	Place	Terminal name	Parcels*		Business parcel express		Business groupage	
			In	Out	In	Out	In	Out
7282	BOGØYVÆR	TRONDHEIM	1	2	0	2	8	8
7284	MAUSUND	TRONDHEIM	1	2	0	2	8	8
7285	GJÆSINGEN	TRONDHEIM	1	2	0	2	8	8
7286	SØRBURØY	TRONDHEIM	1	2	0	2	8	8
7287	SAUØY	TRONDHEIM	1	2	0	2	8	8
7288	SOKNEDAL	TRONDHEIM	1	2	0	1	4	4
7290	STØREN	TRONDHEIM	1	1	0	1	4	4
7295	ROGNES	TRONDHEIM	1	2	0	2	5	5
7298	BUDALEN	TRONDHEIM	1	2	0	2	7	7
7300	ORKANGER	TRONDHEIM	1	1	0	2	3	3
7303	ORKANGER	TRONDHEIM	1	1	0	2	3	3
7310	GJØLME	TRONDHEIM	1	2	0	2	7	7
7316	LENSVIK	TRONDHEIM	1	2	0	2	7	7
7318	AGDENES	TRONDHEIM	1	2	0	2	7	7
7320	FANNREM	TRONDHEIM	1	1	0	1	4	4
7327	SVORKMO	TRONDHEIM	1	1	0	1	4	4
7332	LØKKEN VERK	TRONDHEIM	1	1	0	1	4	4
7334	STORÅS	TRONDHEIM	1	2	0	2	5	5
7335	JERPSTAD	TRONDHEIM	1	2	0	2	5	5
7336	MELDAL	TRONDHEIM	1	1	0	1	4	4
7340	OPPDAL	TRONDHEIM	1	2	0	1	4	4
7342	LØNSET	TRONDHEIM	1	2	0	2	8	8
7343	VOGNILL	TRONDHEIM	1	2	0	2	6	6
7344	OPPDAL	TRONDHEIM	1	2	0	2	6	6
7345	DRIVDALEN	TRONDHEIM	1	2	0	2	5	5

Postcode	Place	Terminal name	Parcels*		Business parcel express		Business groupage	
			In	Out	In	Out	In	Out
7346	OPPDAL	TRONDHEIM	1	2	0	2	5	5
7347	OPPDAL	TRONDHEIM	1	2	0	2	5	5
7350	BUVIKA	TRONDHEIM	1	1	0	2	2	2
7353	BØRSA	TRONDHEIM	1	1	0	1	4	4
7354	VIGGJA	TRONDHEIM	1	2	0	2	6	6
7355	EGGKLEIVA	TRONDHEIM	1	2	0	2	6	6
7357	SKAUN	TRONDHEIM	1	2	0	2	6	6
7370	BREKKEBYGD	RØROS	1	2	0	1	7	7
7372	GLÅMOS	RØROS	1	2	0	1	6	6
7374	RØROS	RØROS	1	2	0	1	0	0
7375	RØROS	RØROS	1	2	0	1	6	6
7380	ÅLEN	RØROS	1	2	0	1	6	6
7383	HALTDALEN	RØROS	1	2	0	1	6	6
7387	SINGSÅS	TRONDHEIM	1	2	0	2	5	5
7391	RENNEBU	TRONDHEIM	1	1	0	1	4	4
7392	RENNEBU	TRONDHEIM	1	2	0	1	4	4
7393	RENNEBU	TRONDHEIM	1	2	0	1	4	4
7397	RENNEBU	TRONDHEIM	1	2	0	1	4	4
7398	RENNEBU	TRONDHEIM	1	2	0	1	4	4
7500	STJØRDAL	TRONDHEIM	1	1	0	2	2	2
7502	STJØRDAL	TRONDHEIM	1	1	0	2	2	2
7503	STJØRDAL	TRONDHEIM	1	1	0	2	2	2
7504	STJØRDAL	TRONDHEIM	1	1	0	2	2	2
7505	STJØRDAL	TRONDHEIM	1	0	0	2	2	2
7506	STJØRDAL	TRONDHEIM	1	1	0	2	2	2

Postcode	Place	Terminal name	Parcels*		Business parcel express		Business groupage	
			In	Out	In	Out	In	Out
7507	STJØRDAL	TRONDHEIM	1	1	0	2	2	2
7509	STJØRDAL	TRONDHEIM	1	1	0	1	2	2
7510	SKATVAL	TRONDHEIM	1	2	0	1	6	6
7512	STJØRDAL	TRONDHEIM	1	1	0	2	2	2
7513	STJØRDAL	TRONDHEIM	1	1	0	1	2	2
7514	STJØRDAL	TRONDHEIM	1	1	0	1	2	2
7517	HELL	TRONDHEIM	1	1	0	2	4	4
7519	ELVARLI	TRONDHEIM	1	2	0	1	4	4
7520	HEGRA	TRONDHEIM	1	2	0	1	3	3
7525	FLORNES	TRONDHEIM	1	2	0	2	6	6
7530	MERÅKER	TRONDHEIM	1	2	0	2	5	5
7533	KOPPERÅ	TRONDHEIM	1	2	0	2	7	7
7540	KLÆBU	TRONDHEIM	1	1	0	0	3	3
7549	TANEM	TRONDHEIM	1	1	0	0	3	3
7550	HOMMELVIK	TRONDHEIM	1	1	0	0	2	2
7560	VIKHAMMER	TRONDHEIM	1	1	0	0	2	2
7562	SAKSVIK	TRONDHEIM	1	1	0	0	2	2
7563	MALVIK	TRONDHEIM	1	1	0	0	2	2
7580	SELBU	TRONDHEIM	1	2	0	2	6	6
7584	SELBUSTRAND	TRONDHEIM	1	2	0	2	6	6
7590	TYDAL	TRONDHEIM	1	2	0	2	8	8
7596	FLAKNAN	TRONDHEIM	1	2	0	2	7	7
7600	LEVANGER	TRONDHEIM	1	1	0	1	4	4
7602	LEVANGER	TRONDHEIM	1	1	0	1	4	4
7603	LEVANGER	TRONDHEIM	1	1	0	1	4	4

Postcode	Place	Terminal name	Parcels*		Business parcel express		Business groupage	
			In	Out	In	Out	In	Out
7604	LEVANGER	TRONDHEIM	1	1	0	1	4	4
7605	LEVANGER	TRONDHEIM	1	1	0	1	4	4
7606	LEVANGER	TRONDHEIM	1	1	0	1	4	4
7607	LEVANGER	TRONDHEIM	1	1	0	1	4	4
7608	LEVANGER	TRONDHEIM	1	2	0	1	4	4
7609	LEVANGER	TRONDHEIM	1	1	0	1	4	4
7620	SKOGN	TRONDHEIM	1	1	0	1	4	4
7622	MARKABYGDA	TRONDHEIM	1	2	0	2	7	7
7623	RONGLAN	TRONDHEIM	1	2	0	2	7	7
7624	EKNE	TRONDHEIM	1	2	0	2	8	8
7629	YTTERØY	TRONDHEIM	1	2	0	2	7	7
7630	ÅSEN	TRONDHEIM	1	2	0	2	7	7
7632	ÅSENFJORD	TRONDHEIM	1	2	0	2	6	6
7633	FROSTA	TRONDHEIM	1	2	0	2	7	7
7650	VERDAL	TRONDHEIM	1	0	0	1	4	4
7652	VERDAL	TRONDHEIM	1	1	0	1	4	4
7653	VERDAL	TRONDHEIM	1	1	0	1	4	4
7654	VERDAL	TRONDHEIM	1	1	0	1	4	4
7655	VERDAL	TRONDHEIM	1	1	0	1	4	4
7656	VERDAL	TRONDHEIM	1	1	0	1	4	4
7657	VERDAL	TRONDHEIM	1	1	0	1	4	4
7660	VUKU	TRONDHEIM	1	2	0	2	8	8
7670	INDERØY	TRONDHEIM	1	2	0	2	7	7
7690	MOSVIK	TRONDHEIM	1	2	0	2	8	8
7710	SPARBU	TRONDHEIM	1	2	0	2	8	8

Postcode	Place	Terminal name	Parcels*		Business parcel express		Business groupage	
			In	Out	In	Out	In	Out
7711	STEINKJER	TRONDHEIM	1	2	0	2	4	4
7712	STEINKJER	TRONDHEIM	1	1	0	1	4	4
7713	STEINKJER	TRONDHEIM	1	0	0	1	4	4
7714	STEINKJER	TRONDHEIM	1	1	0	1	4	4
7715	STEINKJER	TRONDHEIM	1	1	0	1	4	4
7716	STEINKJER	TRONDHEIM	1	1	0	1	4	4
7717	STEINKJER	TRONDHEIM	1	2	0	1	4	4
7718	STEINKJER	TRONDHEIM	1	2	0	1	4	4
7724	STEINKJER	TRONDHEIM	1	2	0	2	4	4
7725	STEINKJER	TRONDHEIM	1	1	0	1	4	4
7730	BEITSTAD	TRONDHEIM	1	2	0	2	8	8
7732	STEINKJER	TRONDHEIM	1	2	0	1	4	4
7740	STEINSDALEN	TRONDHEIM	1	2	0	2	8	8
7742	YTTERVÅG	TRONDHEIM	1	2	0	2	8	8
7744	HEPSØY	TRONDHEIM	1	2	0	2	8	8
7745	OPPLAND	TRONDHEIM	1	2	0	2	8	8
7746	HASVÅG	TRONDHEIM	1	2	0	2	8	8
7748	SETER	TRONDHEIM	1	2	0	2	8	8
7750	NAMDALSEID	TRONDHEIM	1	2	0	2	8	8
7760	SNÅSA	TRONDHEIM	1	2	0	2	8	8
7770	FLATANGER	TRONDHEIM	1	2	0	2	8	8
7777	NORD-STATLAND	TRONDHEIM	1	2	0	2	8	8
7790	MALM	TRONDHEIM	1	2	0	2	8	8
7796	FOLLAFOSS	TRONDHEIM	1	2	0	2	8	8
7797	VERRABOTN	TRONDHEIM	1	2	0	2	8	8

Postcode	Place	Terminal name	Parcels*		Business parcel express		Business groupage	
			In	Out	In	Out	In	Out
7800	NAMSOS	TRONDHEIM	1	2	0	2	6	6
7802	NAMSOS	TRONDHEIM	1	2	0	2	6	6
7803	NAMSOS	TRONDHEIM	1	2	0	2	6	6
7804	NAMSOS	TRONDHEIM	1	2	0	2	6	6
7805	NAMSOS	TRONDHEIM	1	2	0	2	6	6
7810	NAMSOS	TRONDHEIM	1	2	0	2	6	6
7817	SALSNES	TRONDHEIM	1	2	0	2	8	8
7818	LUND	TRONDHEIM	1	2	0	2	8	8
7819	FOSSLANDSOSEN	TRONDHEIM	1	2	0	2	8	8
7820	SPILLUM	TRONDHEIM	1	2	0	2	6	6
7822	BANGSUND	TRONDHEIM	1	2	0	2	8	8
7856	JØA	TRONDHEIM	1	2	0	2	8	8
7860	SKAGE I NAMDALEN	TRONDHEIM	1	2	0	2	8	8
7863	OVERHALLA	TRONDHEIM	1	2	0	2	8	8
7870	GRONG	TRONDHEIM	1	2	0	2	8	8
7873	HARRAN	TRONDHEIM	1	2	0	2	8	8
7876	KONGSMOEN	TRONDHEIM	1	2	0	2	8	8
7877	HØYLANDET	TRONDHEIM	1	2	0	2	8	8
7882	NORDLI	TRONDHEIM	1	2	0	2	8	8
7884	SØRLI	TRONDHEIM	1	2	0	2	8	8
7890	NAMSSKOGAN	TRONDHEIM	1	2	0	2	7	7
7892	TRONES	TRONDHEIM	1	2	0	2	8	8
7893	SKOROVATN	TRONDHEIM	1	2	0	2	8	8
7896	BREKKVASSSELV	TRONDHEIM	1	2	0	2	8	8
7898	LIMINGEN	TRONDHEIM	1	2	0	2	8	8

Postcode	Place	Terminal name	Parcels*		Business parcel express		Business groupage	
			In	Out	In	Out	In	Out
7900	RØRVIK	TRONDHEIM	1	2	0	2	8	8
7924	AUSTAFJORD	TRONDHEIM	1	2	0	2	8	8
7940	OTTERSØY	TRONDHEIM	1	2	0	2	8	8
7944	INDRE NÆRØY	TRONDHEIM	1	2	0	2	8	8
7950	ABELVÆR	TRONDHEIM	1	2	0	2	7	7
7960	SALSBRUKET	TRONDHEIM	1	2	0	2	8	8
7970	KOLVEREID	TRONDHEIM	1	2	0	2	8	8
7973	GJERDINGA	TRONDHEIM	1	2	0	2	8	8
7980	TERRÅK	TRONDHEIM	1	2	0	2	6	6
7981	HARANGSFJORD	TRONDHEIM	1	2	0	2	5	5
7982	BINDALSEIDET	TRONDHEIM	1	2	0	2	6	6
7985	FOLDEREID	TRONDHEIM	1	2	0	2	8	8
7990	NAUSTBUKTA	TRONDHEIM	1	2	0	2	8	8
7993	GUTVIK	TRONDHEIM	1	2	0	2	8	8
7994	LEKA	TRONDHEIM	1	2	0	2	8	8
8003	BODØ	FAUSKE	0	0	0	1	0	0
8004	BODØ	FAUSKE	0	0	0	1	0	0
8005	BODØ	FAUSKE	0	0	0	1	0	0
8006	BODØ	FAUSKE	0	0	0	1	0	0
8007	BODØ	FAUSKE	0	0	0	1	0	0
8008	BODØ	FAUSKE	0	0	0	1	0	0
8009	BODØ	FAUSKE	0	0	0	1	0	0
8010	BODØ	FAUSKE	0	0	0	1	0	0
8011	BODØ	FAUSKE	0	1	0	1	0	0
8012	BODØ	FAUSKE	0	0	0	1	0	0

Postcode	Place	Terminal name	Parcels*		Business parcel express		Business groupage	
			In	Out	In	Out	In	Out
8013	BODØ	FAUSKE	0	0	0	1	0	0
8014	BODØ	FAUSKE	0	0	0	1	0	0
8015	BODØ	FAUSKE	0	0	0	1	0	0
8016	BODØ	FAUSKE	1	1	0	1	3	3
8019	BODØ	FAUSKE	0	0	0	1	0	0
8020	BODØ	FAUSKE	0	1	0	1	1	1
8021	BODØ	FAUSKE	0	0	0	1	1	1
8022	BODØ	FAUSKE	0	0	0	1	1	1
8023	BODØ	FAUSKE	0	0	0	1	1	1
8025	BODØ	FAUSKE	0	0	0	1	8	8
8026	BODØ	FAUSKE	0	0	0	1	1	1
8027	BODØ	FAUSKE	0	0	0	1	1	1
8028	BODØ	FAUSKE	0	0	0	1	1	1
8029	BODØ	FAUSKE	0	0	0	1	1	1
8030	BODØ	FAUSKE	0	1	0	1	1	1
8050	TVERLANDET	FAUSKE	1	1	0	0	3	3
8056	SALTSTRAUMEN	FAUSKE	1	2	0	1	4	4
8063	VÆRØY	FAUSKE	1	2	0	1	8	8
8064	RØST	FAUSKE	1	2	0	2	8	8
8070	BODØ	FAUSKE	0	0	0	1	0	0
8071	BODØ	FAUSKE	0	0	0	1	0	0
8072	BODØ	FAUSKE	0	0	0	1	0	0
8073	BODØ	FAUSKE	0	1	0	1	0	0
8074	BODØ	FAUSKE	0	0	0	1	0	0
8075	BODØ	FAUSKE	0	0	0	1	0	0

Postcode	Place	Terminal name	Parcels*		Business parcel express		Business groupage	
			In	Out	In	Out	In	Out
8076	BODØ	FAUSKE	0	0	0	1	0	0
8079	BODØ	FAUSKE	0	0	0	1	0	0
8093	KJERRINGØY	FAUSKE	1	2	0	2	8	8
8094	FLEINVÆR	FAUSKE	1	2	0	2	5	5
8095	HELLIGVÆR	FAUSKE	1	2	0	2	5	5
8096	BLIKSVÆR	FAUSKE	1	2	0	2	5	5
8097	GIVÆR	FAUSKE	1	2	0	2	5	5
8098	LANDEGODE	FAUSKE	1	2	0	2	5	5
8099	JAN MAYEN	FAUSKE	1	2	0	2	0	0
8100	MISVÆR	FAUSKE	1	2	0	2	6	6
8102	SKJERSTAD	FAUSKE	1	2	0	2	6	6
8103	BREIVIK I SALTEN	FAUSKE	1	2	0	2	7	7
8110	MOLDJORD	FAUSKE	1	2	0	2	6	6
8114	TOLLÅ	FAUSKE	1	2	0	2	6	6
8120	NYGÅRDSJØEN	FAUSKE	1	2	0	2	4	4
8128	YTRE BEIARN	FAUSKE	1	2	0	2	5	5
8130	SANDHORNØY	FAUSKE	1	2	0	2	7	7
8135	SØRARNØY	FAUSKE	1	2	0	2	5	5
8136	NORDARNØY	FAUSKE	1	2	0	2	5	5
8140	INNDYR	FAUSKE	1	2	0	2	8	8
8145	STORVIK	FAUSKE	1	2	0	2	8	8
8146	REIPÅ	FAUSKE	1	2	0	2	8	8
8149	NEVERDAL	FAUSKE	1	2	0	2	8	8
8150	ØRNES	FAUSKE	1	2	0	2	8	8
8157	MELØY	FAUSKE	1	2	0	2	8	8

Postcode	Place	Terminal name	Parcels*		Business parcel express		Business groupage	
			In	Out	In	Out	In	Out
8158	BOLGA	FAUSKE	1	2	0	2	8	8
8159	STØTT	FAUSKE	1	2	0	2	8	8
8160	GLOMFJORD	FAUSKE	1	2	0	2	8	8
8170	ENGAVÅGEN	FAUSKE	1	2	0	2	8	8
8178	HALSA	FAUSKE	1	2	0	2	8	8
8181	MYKEN	FAUSKE	1	2	0	2	8	8
8182	MELFJORDBOTN	FAUSKE	1	2	0	2	8	8
8184	ÅGSKARDET	FAUSKE	1	2	0	2	8	8
8185	VÅGAHOLMEN	FAUSKE	1	2	0	2	8	8
8186	TJONGSFJORDEN	FAUSKE	1	2	0	2	8	8
8187	JEKTVIK	FAUSKE	1	2	0	2	8	8
8188	NORDVERNES	FAUSKE	1	2	0	2	8	8
8189	GJERSVIKGRENDA	FAUSKE	1	2	0	2	5	5
8190	SØRFJORDEN	FAUSKE	1	2	0	2	8	8
8193	RØDØY	FAUSKE	1	2	0	2	8	8
8195	GJERØY	FAUSKE	1	2	0	2	8	8
8196	SELSØYVIK	FAUSKE	1	2	0	2	8	8
8197	STORSELSØY	FAUSKE	1	2	0	2	8	8
8198	NORDNESØY	FAUSKE	1	2	0	2	8	8
8200	FAUSKE	FAUSKE	0	0	0	1	0	0
8206	FAUSKE	FAUSKE	0	1	0	1	0	0
8207	FAUSKE	FAUSKE	0	0	0	0	0	0
8208	FAUSKE	FAUSKE	0	0	0	1	0	0
8209	FAUSKE	FAUSKE	0	0	0	1	0	0
8210	FAUSKE	FAUSKE	0	0	0	1	0	0

Postcode	Place	Terminal name	Parcels*		Business parcel express		Business groupage	
			In	Out	In	Out	In	Out
8211	FAUSKE	FAUSKE	0	2	0	1	0	0
8214	FAUSKE	FAUSKE	0	2	0	1	0	0
8215	VALNESFJORD	FAUSKE	1	2	0	1	3	3
8218	FAUSKE	FAUSKE	0	1	0	1	0	0
8219	FAUSKE	FAUSKE	0	2	0	1	0	0
8220	RØSVIK	FAUSKE	1	2	0	2	7	7
8226	STRAUMEN	FAUSKE	1	2	0	1	4	4
8230	SULITJELMA	FAUSKE	1	2	0	2	7	7
8250	ROGNAN	FAUSKE	1	1	0	1	4	4
8252	ROGNAN	FAUSKE	1	1	0	1	4	4
8253	ROGNAN	FAUSKE	1	1	0	1	4	4
8255	RØKLAND	FAUSKE	1	2	0	2	7	7
8260	INNHAVET	FAUSKE	1	2	0	2	8	8
8264	ENGAN	FAUSKE	1	2	0	2	8	8
8266	MØRSVIKBOTN	FAUSKE	1	2	0	2	8	8
8270	DRAG	FAUSKE	1	2	0	2	8	8
8273	NEVERVIK	FAUSKE	1	2	0	2	8	8
8274	MUSKEN	FAUSKE	1	2	0	2	8	8
8275	STORJORD I TYSFJORD	FAUSKE	1	2	0	2	8	8
8276	ULVSVÅG	FAUSKE	1	2	0	2	8	8
8278	STORÅ	FAUSKE	1	2	0	2	8	8
8283	LEINESFJORD	FAUSKE	1	2	0	2	8	8
8285	LEINES	FAUSKE	1	2	0	2	8	8
8286	NORDFOLD	FAUSKE	1	2	0	2	8	8
8288	BOGØY	FAUSKE	1	2	0	2	8	8

Postcode	Place	Terminal name	Parcels*		Business parcel express		Business groupage	
			In	Out	In	Out	In	Out
8289	ENGELØYA	FAUSKE	1	2	0	2	8	8
8290	SKUTVIK	FAUSKE	1	2	0	2	8	8
8294	HAMARØY	FAUSKE	1	2	0	2	8	8
8297	TRANØY	FAUSKE	1	2	0	2	8	8
8300	SVOLVÆR	LEKNES	1	1	0	1	4	4
8310	KABELVÅG	LEKNES	1	1	0	1	4	4
8312	HENNINGSVÆR	LEKNES	1	1	0	1	4	4
8313	KLEPPSTAD	LEKNES	1	2	0	1	4	4
8314	GIMSØYSAND	LEKNES	1	2	0	1	4	4
8315	LAUKVIK	LEKNES	1	2	0	2	5	5
8316	LAUPSTAD	LEKNES	1	2	0	2	5	5
8317	STRØNSTAD	LEKNES	1	2	0	2	5	5
8320	SKROVA	LEKNES	1	2	0	2	8	8
8322	BRETTESNES	LEKNES	1	2	0	2	8	8
8323	STORFJELL	LEKNES	1	2	0	2	8	8
8324	DIGERMULEN	LEKNES	1	2	0	2	8	8
8325	TENGELFJORD	LEKNES	1	2	0	2	8	8
8326	MYRLAND	LEKNES	1	2	0	2	4	4
8328	STORMOLLA	LEKNES	1	2	0	2	8	8
8340	STAMSUND	LEKNES	1	1	0	1	4	4
8352	SENNESVIK	LEKNES	1	2	0	1	4	4
8357	VALBERG	LEKNES	1	2	0	1	4	4
8360	BØSTAD	LEKNES	1	2	0	1	4	4
8370	LEKNES	LEKNES	0	1	0	0	0	0
8372	GRAVDAL	LEKNES	0	1	0	0	0	0

Postcode	Place	Terminal name	Parcels*		Business parcel express		Business groupage	
			In	Out	In	Out	In	Out
8373	BALLSTAD	LEKNES	1	1	0	1	4	4
8380	RAMBERG	LEKNES	1	1	0	1	4	4
8382	NAPP	LEKNES	1	2	0	1	4	4
8384	SUND I LOFOTEN	LEKNES	1	1	0	1	4	4
8385	MØLNARODDEN	LEKNES	1	1	0	1	4	4
8387	FREDVANG	LEKNES	1	2	0	1	4	4
8390	REINE	LEKNES	1	2	0	2	5	5
8392	SØRVÅGEN	LEKNES	1	2	0	2	5	5
8400	SORTLAND	SORTLAND	0	1	0	1	0	0
8402	SORTLAND	SORTLAND	0	0	0	0	0	0
8403	SORTLAND	SORTLAND	0	0	0	0	0	0
8404	SORTLAND	SORTLAND	0	1	0	0	0	0
8406	SORTLAND	SORTLAND	0	2	0	0	0	0
8407	SORTLAND	SORTLAND	0	2	0	0	0	0
8408	SORTLAND	SORTLAND	0	2	0	0	0	0
8409	GULLESFJORD	SORTLAND	1	2	0	1	4	4
8410	LØDINGEN	NARVIK	1	2	0	2	7	7
8412	VESTBYGD	NARVIK	1	2	0	2	8	8
8413	KVITNES	SORTLAND	1	2	0	1	4	4
8414	HENNES	SORTLAND	1	2	0	2	6	6
8415	SORTLAND	SORTLAND	0	2	0	0	0	0
8416	SORTLAND	SORTLAND	0	2	0	0	0	0
8426	BARKESTAD	SORTLAND	1	2	0	2	5	5
8428	TUNSTAD	SORTLAND	1	2	0	2	5	5
8430	MYRE	SORTLAND	1	1	0	1	4	4

Postcode	Place	Terminal name	Parcels*		Business parcel express		Business groupage	
			In	Out	In	Out	In	Out
8432	ALSVÅG	SORTLAND	1	1	0	1	4	4
8438	STØ	SORTLAND	1	2	0	2	5	5
8445	MELBU	SORTLAND	1	1	0	1	3	3
8447	LONKAN	SORTLAND	1	2	0	2	6	6
8450	STOKMARKNES	SORTLAND	1	1	0	1	4	4
8470	BØ I VESTERÅLEN	SORTLAND	1	1	0	1	4	4
8475	STRAUMSJØEN	SORTLAND	1	2	0	2	6	6
8480	ANDENES	SORTLAND	1	1	0	2	4	4
8481	BLEIK	SORTLAND	1	1	0	2	4	4
8484	RISØYHAMN	SORTLAND	1	2	0	2	4	4
8485	DVERBERG	SORTLAND	1	2	0	2	4	4
8488	NØSS	SORTLAND	1	2	0	1	4	4
8489	NORDMELA	SORTLAND	1	2	0	1	4	4
8514	NARVIK	NARVIK	0	0	0	1	0	0
8515	NARVIK	NARVIK	0	0	0	1	0	0
8516	NARVIK	NARVIK	0	0	0	1	0	0
8517	NARVIK	NARVIK	0	1	0	1	0	0
8519	NARVIK	NARVIK	0	0	0	1	0	0
8520	ANKENES	NARVIK	0	2	0	1	0	0
8521	ANKENES	NARVIK	0	0	0	1	4	4
8522	BEISFJORD	NARVIK	1	1	0	1	4	4
8523	SKJOMEN	NARVIK	1	2	0	1	4	4
8530	BJERKVIK	NARVIK	0	1	0	0	0	0
8533	BOGEN I OFOTEN	NARVIK	1	2	0	1	6	6
8534	LILAND	NARVIK	1	2	0	1	6	6

Postcode	Place	Terminal name	Parcels*		Business parcel express		Business groupage	
			In	Out	In	Out	In	Out
8535	TÅRSTAD	NARVIK	1	2	0	1	6	6
8536	EVENES	NARVIK	1	1	0	1	4	4
8540	BALLANGEN	NARVIK	1	2	0	2	4	4
8543	KJELDEBOTN	NARVIK	1	2	0	2	6	6
8590	KJØPSVIK	NARVIK	1	2	0	2	8	8
8610	MO I RANA	MO I RANA	0	1	0	0	0	0
8611	MO I RANA	MO I RANA	0	0	0	0	0	0
8613	MO I RANA	MO I RANA	0	1	0	2	0	0
8614	MO I RANA	MO I RANA	0	1	0	2	0	0
8615	SKONSENG	MO I RANA	1	2	0	0	4	4
8616	MO I RANA	MO I RANA	0	1	0	2	0	0
8617	DALSGRENDA	MO I RANA	1	2	0	1	4	4
8618	MO I RANA	MO I RANA	0	2	0	0	0	0
8622	MO I RANA	MO I RANA	0	1	0	2	0	0
8624	MO I RANA	MO I RANA	0	0	0	2	0	0
8626	MO I RANA	MO I RANA	0	0	0	2	0	0
8630	STORFORSHEIA	MO I RANA	1	2	0	1	4	4
8640	HEMNESBERGET	MO I RANA	1	1	0	1	4	4
8642	FINNEIDFJORD	MO I RANA	1	2	0	1	3	3
8643	BJERKA	MO I RANA	1	2	0	1	3	3
8646	KORGEN	MO I RANA	1	2	0	1	3	3
8647	BLEIKVASSLIA	MO I RANA	1	2	0	2	7	7
8656	MOSJØEN	MO I RANA	1	1	0	1	3	3
8657	MOSJØEN	MO I RANA	1	0	0	1	3	3
8658	MOSJØEN	MO I RANA	1	2	0	1	3	3

Postcode	Place	Terminal name	Parcels*		Business parcel express		Business groupage	
			In	Out	In	Out	In	Out
8659	MOSJØEN	MO I RANA	1	2	0	1	3	3
8660	MOSJØEN	MO I RANA	1	1	0	1	3	3
8661	MOSJØEN	MO I RANA	1	0	0	1	3	3
8663	MOSJØEN	MO I RANA	1	1	0	1	3	3
8664	MOSJØEN	MO I RANA	1	2	0	1	3	3
8665	MOSJØEN	MO I RANA	1	1	0	1	3	3
8666	MOSJØEN	MO I RANA	1	1	0	2	3	3
8672	ELSFJORD	MO I RANA	1	2	0	2	7	7
8682	TROFORS	MO I RANA	1	2	0	2	5	5
8683	TROFORS	MO I RANA	1	2	0	2	5	5
8684	TROFORS	MO I RANA	1	2	0	2	5	5
8685	TROFORS	MO I RANA	1	2	0	2	5	5
8692	HATTFJELLDAL	MO I RANA	1	2	0	2	8	8
8693	HATTFJELLDAL	MO I RANA	1	2	0	2	8	8
8694	HATTFJELLDAL	MO I RANA	1	2	0	2	8	8
8695	HATTFJELLDAL	MO I RANA	1	2	0	2	8	8
8696	HATTFJELLDAL	MO I RANA	1	2	0	2	8	8
8700	NESNA	MO I RANA	1	2	0	2	5	5
8704	NESNASTRANDA	MO I RANA	1	2	0	2	5	5
8705	STRANDLANDET	MO I RANA	1	2	0	2	5	5
8720	VIKHOLMEN	MO I RANA	1	2	0	2	8	8
8723	HUSBY	MO I RANA	1	2	0	2	8	8
8724	SAURA	MO I RANA	1	2	0	2	8	8
8725	UTSKARPEN	MO I RANA	1	2	0	2	8	8
8730	BRATLAND	MO I RANA	1	2	0	2	8	8

Postcode	Place	Terminal name	Parcels*		Business parcel express		Business groupage	
			In	Out	In	Out	In	Out
8732	ALDRA	MO I RANA	1	2	0	2	6	6
8733	STUVLAND	MO I RANA	1	2	0	2	8	8
8735	STOKKVÅGEN	MO I RANA	1	2	0	2	8	8
8740	NORD-SOLVÆR	MO I RANA	1	2	0	2	8	8
8742	SELVÆR	MO I RANA	1	2	0	2	8	8
8743	INDRE KVARØY	MO I RANA	1	2	0	2	8	8
8750	TONNES	MO I RANA	1	2	0	2	7	7
8752	KONSVIKOSEN	MO I RANA	1	2	0	2	7	7
8754	ØRESVIK	MO I RANA	1	2	0	2	7	7
8762	SLENESET	MO I RANA	1	2	0	2	8	8
8764	LOVUND	MO I RANA	1	2	0	2	8	8
8766	LURØY	MO I RANA	1	2	0	2	8	8
8770	TRÆNA	MO I RANA	1	2	0	2	8	8
8800	SANDNESSJØEN	SANDNESSJØEN	0	1	0	1	0	0
8802	SANDNESSJØEN	SANDNESSJØEN	0	0	0	1	0	0
8803	SANDNESSJØEN	SANDNESSJØEN	0	1	0	1	0	0
8804	SANDNESSJØEN	SANDNESSJØEN	0	2	0	0	0	0
8813	LØKTA	SANDNESSJØEN	1	2	0	2	6	6
8820	DØNNA	SANDNESSJØEN	1	2	0	2	5	5
8830	VANDVE	SANDNESSJØEN	1	2	0	2	7	7
8842	BRASØY	SANDNESSJØEN	1	2	0	2	7	7
8844	SANDVÆR	SANDNESSJØEN	1	2	0	2	5	5
8850	HERØY	SANDNESSJØEN	1	2	0	2	5	5
8854	AUSTBØ	SANDNESSJØEN	1	2	0	2	7	7
8860	TJØTTA	SANDNESSJØEN	1	2	0	2	7	7

Postcode	Place	Terminal name	Parcels*		Business parcel express		Business groupage	
			In	Out	In	Out	In	Out
8865	TRO	SANDNESSJØEN	1	2	0	2	4	4
8870	VISTHUS	SANDNESSJØEN	1	2	0	2	8	8
8880	BÆRØYVÅGEN	SANDNESSJØEN	1	2	0	2	8	8
8890	LEIRFJORD	SANDNESSJØEN	1	2	0	2	8	8
8892	SUNDØY	MO I RANA	1	2	0	2	8	8
8897	BARDAL	SANDNESSJØEN	1	2	0	2	5	5
8900	BRØNNØYSUND	BRØNNØYSUND	0	0	0	0	0	0
8904	BRØNNØYSUND	BRØNNØYSUND	0	1	0	0	0	0
8906	BRØNNØYSUND	BRØNNØYSUND	0	1	0	0	0	0
8907	BRØNNØYSUND	BRØNNØYSUND	0	0	0	0	0	0
8908	BRØNNØYSUND	BRØNNØYSUND	0	2	0	0	0	0
8909	BRØNNØYSUND	BRØNNØYSUND	0	1	0	0	0	0
8920	SØMNA	BRØNNØYSUND	1	1	0	1	4	4
8960	VELFJORD	BRØNNØYSUND	1	2	0	2	4	4
8976	VEVELSTAD	BRØNNØYSUND	1	2	0	2	4	4
8982	VEGA	BRØNNØYSUND	1	2	0	2	5	5
8983	VEGA	BRØNNØYSUND	1	2	0	2	5	5
8984	VEGA	BRØNNØYSUND	1	2	0	2	5	5
8985	YLVIINGEN	BRØNNØYSUND	1	2	0	2	5	5
8986	VEGA	BRØNNØYSUND	1	2	0	2	5	5
9006	TROMSØ	TROMSØ	0	0	0	1	0	0
9007	TROMSØ	TROMSØ	0	0	0	1	0	0
9008	TROMSØ	TROMSØ	0	0	0	1	0	0
9009	TROMSØ	TROMSØ	0	0	0	1	0	0
9010	TROMSØ	TROMSØ	0	0	0	1	0	0

Postcode	Place	Terminal name	Parcels*		Business parcel express		Business groupage	
			In	Out	In	Out	In	Out
9011	TROMSØ	TROMSØ	0	0	0	1	0	0
9012	TROMSØ	TROMSØ	0	0	0	1	0	0
9013	TROMSØ	TROMSØ	0	0	0	1	0	0
9014	TROMSØ	TROMSØ	0	0	0	1	0	0
9015	TROMSØ	TROMSØ	0	0	0	1	0	0
9016	TROMSØ	TROMSØ	0	0	0	1	0	0
9017	TROMSØ	TROMSØ	0	0	0	1	0	0
9018	TROMSØ	TROMSØ	0	0	0	1	0	0
9019	TROMSØ	TROMSØ	0	0	0	1	0	0
9020	TROMSDALEN	TROMSØ	0	1	0	1	0	0
9021	TROMSDALEN	TROMSØ	0	1	0	1	0	0
9022	KROKELVDALEN	TROMSØ	1	1	0	0	2	2
9023	KROKELVDALEN	TROMSØ	1	2	0	0	2	2
9024	TOMASJORD	TROMSØ	0	0	0	1	0	0
9027	RAMFJORBOTN	TROMSØ	1	2	0	1	6	6
9030	SJURSNES	TROMSØ	1	2	0	2	8	8
9034	OLDERVIK	TROMSØ	1	2	0	1	8	8
9040	NORDKJOSBOTN	TROMSØ	1	2	0	1	4	4
9042	LAKSVATN	TROMSØ	1	2	0	1	6	6
9043	JØVIK	TROMSØ	1	2	0	2	8	8
9045	LAKSELVBUKT	TROMSØ	1	2	0	2	8	8
9046	OTEREN	TROMSØ	1	2	0	2	7	7
9050	STORSTEINNES	TROMSØ	1	2	0	2	6	6
9055	MEISTERVIK	TROMSØ	1	2	0	2	7	7
9056	MORTENHALS	TROMSØ	1	2	0	2	7	7

Postcode	Place	Terminal name	Parcels*		Business parcel express		Business groupage	
			In	Out	In	Out	In	Out
9057	VIKRAN	TROMSØ	1	2	0	1	7	7
9060	LYNGSEIDET	TROMSØ	1	2	0	2	7	7
9062	FURUFLATEN	TROMSØ	1	2	0	2	7	7
9064	SVENSBY	TROMSØ	1	2	0	2	7	7
9068	NORD-LENANGEN	TROMSØ	1	2	0	2	8	8
9100	KVALØYSLETTA	TROMSØ	1	1	0	1	4	4
9101	KVALØYSLETTA	TROMSØ	1	1	0	1	4	4
9102	KVALØYSLETTA	TROMSØ	1	1	0	1	4	4
9103	KVALØYA	TROMSØ	1	2	0	2	8	8
9104	KVALØYA	TROMSØ	1	1	0	1	4	4
9105	KVALØYA	TROMSØ	1	1	0	0	4	4
9106	STRAUMSBUKTA	TROMSØ	1	2	0	1	7	7
9107	KVALØYA	TROMSØ	1	2	0	2	8	8
9108	KVALØYA	TROMSØ	1	2	0	1	8	8
9109	KVALØYA	TROMSØ	1	2	0	1	8	8
9110	SOMMARØY	TROMSØ	1	2	0	1	7	7
9118	BRENSHOLMEN	TROMSØ	1	2	0	1	7	7
9120	VENGSØY	TROMSØ	1	2	0	2	8	8
9128	TUSSØY	TROMSØ	1	2	0	2	8	8
9130	HANSNES	TROMSØ	1	2	0	2	6	6
9131	KÅRVIK	TROMSØ	1	2	0	2	8	8
9132	STAKKVIK	TROMSØ	1	2	0	2	8	8
9135	VANNVÅG	TROMSØ	1	2	0	2	8	8
9136	VANNAREID	TROMSØ	1	2	0	2	8	8
9138	KARLSØY	TROMSØ	1	2	0	2	8	8

Postcode	Place	Terminal name	Parcels*		Business parcel express		Business groupage	
			In	Out	In	Out	In	Out
9140	REBBENES	TROMSØ	1	2	0	2	8	8
9141	MJØLVIK	TROMSØ	1	2	0	2	8	8
9143	SKIBOTN	TROMSØ	1	2	0	2	8	8
9144	SAMUELSBERG	TROMSØ	1	2	0	2	8	8
9146	OLDERDALEN	TROMSØ	1	2	0	2	8	8
9147	BIRTAVARRE	TROMSØ	1	2	0	2	8	8
9151	STORSLETT	TROMSØ	1	2	0	2	8	8
9152	SØRKJOSEN	TROMSØ	1	2	0	2	8	8
9153	ROTSUND	TROMSØ	1	2	0	2	8	8
9154	STORSLETT	TROMSØ	1	2	0	2	8	8
9157	STORSLETT	TROMSØ	1	2	0	2	8	8
9158	STORSLETT	TROMSØ	1	2	0	2	8	8
9159	HAVNNES	TROMSØ	1	2	0	2	8	8
9161	BURFJORD	ALTA	1	2	0	2	8	8
9162	SØRSTRAUMEN	ALTA	1	2	0	2	8	8
9163	JØKELFJORD	ALTA	1	2	0	2	8	8
9170	LONGYEARBYEN	TROMSØ	1	2	0	2	0	0
9173	NY-ÅLESUND	TROMSØ	1	2	0	2	0	0
9174	HOPEN	TROMSØ	1	2	0	2	0	0
9175	SVEAGRUVA	TROMSØ	1	2	0	2	0	0
9176	BJØRNØYA	TROMSØ	1	2	0	2	0	0
9178	BARENTSBURG	TROMSØ	1	2	0	2	0	0
9180	SKJERVØY	TROMSØ	1	2	0	2	7	7
9181	HAMNEIDET	TROMSØ	1	2	0	2	8	8
9182	SEGLVIK	TROMSØ	1	2	0	2	8	8

Postcode	Place	Terminal name	Parcels*		Business parcel express		Business groupage	
			In	Out	In	Out	In	Out
9184	REINFJORD	TROMSØ	1	2	0	2	8	8
9185	SPILDRA	TROMSØ	1	2	0	2	8	8
9186	ANDSNES	TROMSØ	1	2	0	2	6	6
9187	VALANHAMN	ALTA	1	2	0	2	8	8
9190	AKKARVIK	TROMSØ	1	2	0	2	8	8
9192	ARNØYHAMN	TROMSØ	1	2	0	2	8	8
9193	NIKKEBY	TROMSØ	1	2	0	2	8	8
9194	LAUKSLETTA	TROMSØ	1	2	0	2	8	8
9195	ÅRVIKSAND	TROMSØ	1	2	0	2	8	8
9197	ULØYBUKT	TROMSØ	1	2	0	2	8	8
9300	FINNSNES	NARVIK	1	2	0	2	5	5
9302	ROSSFJORDSTRAUMEN	NARVIK	1	2	0	2	6	6
9303	SILSAND	NARVIK	1	2	0	2	6	6
9304	VANGSVIK	NARVIK	1	2	0	2	6	6
9307	FINNSNES	NARVIK	1	2	0	2	5	5
9308	FINNSNES	NARVIK	1	2	0	2	5	5
9309	FINNSNES	NARVIK	1	2	0	2	5	5
9310	SØRREISA	NARVIK	1	2	0	2	6	6
9311	BRØSTADBOTN	NARVIK	1	2	0	2	6	6
9321	MOEN	NARVIK	1	2	0	2	6	6
9322	KARLSTAD	NARVIK	1	2	0	2	5	5
9325	BARDUFOSS	NARVIK	1	2	0	2	5	5
9334	ØVERBYGD	NARVIK	1	2	0	2	6	6
9336	RUNDHAUG	NARVIK	1	2	0	2	6	6
9350	SJØVEGAN	NARVIK	1	2	0	2	6	6

Postcode	Place	Terminal name	Parcels*		Business parcel express		Business groupage	
			In	Out	In	Out	In	Out
9357	TENNEVOLL	NARVIK	1	2	0	1	4	4
9360	BARDU	NARVIK	1	2	0	2	5	5
9372	GIBOSTAD	NARVIK	1	2	0	2	6	6
9373	BOTNHAMN	NARVIK	1	2	0	2	6	6
9376	SKATVIK	NARVIK	1	2	0	2	6	6
9380	GRYLLEFJORD	NARVIK	1	2	0	2	6	6
9381	TORSKEN	NARVIK	1	2	0	2	6	6
9385	SKALAND	NARVIK	1	2	0	2	6	6
9386	SENJAHOPEN	NARVIK	1	2	0	2	6	6
9388	FJORDGARD	NARVIK	1	2	0	2	6	6
9389	HUSØY I SENJA	NARVIK	1	2	0	2	6	6
9392	STONGLANDSEIDET	NARVIK	1	2	0	2	6	6
9393	FLAKSTADVÅG	NARVIK	1	2	0	2	6	6
9395	KALDFARNES	NARVIK	1	2	0	2	6	6
9402	HARSTAD	HARSTAD	0	2	0	1	0	0
9403	HARSTAD	HARSTAD	0	0	0	1	0	0
9404	HARSTAD	HARSTAD	0	0	0	1	0	0
9405	HARSTAD	HARSTAD	0	0	0	1	0	0
9406	HARSTAD	HARSTAD	0	0	0	1	0	0
9407	HARSTAD	HARSTAD	0	0	0	1	0	0
9408	HARSTAD	HARSTAD	0	0	0	1	0	0
9409	HARSTAD	HARSTAD	0	0	0	1	0	0
9411	HARSTAD	HARSTAD	0	0	0	1	0	0
9414	HARSTAD	HARSTAD	0	0	0	1	0	0
9415	HARSTAD	HARSTAD	0	1	0	1	0	0

Postcode	Place	Terminal name	Parcels*		Business parcel express		Business groupage	
			In	Out	In	Out	In	Out
9419	SØRVIK	HARSTAD	1	1	0	1	4	4
9420	LUNDENES	HARSTAD	1	2	0	2	5	5
9423	GRØTAVÆR	HARSTAD	1	2	0	2	7	7
9424	KJØTTA	HARSTAD	1	2	0	2	8	8
9425	SANDSØY	HARSTAD	1	2	0	2	8	8
9426	BJARKØY	HARSTAD	1	2	0	2	8	8
9427	MELØYVÆR	HARSTAD	1	2	0	2	8	8
9430	SANDTORG	NARVIK	1	2	0	1	5	5
9436	KONGSVIK	NARVIK	1	2	0	1	5	5
9440	EVENSKJER	NARVIK	1	2	0	1	5	5
9441	FJELLDAL	NARVIK	1	2	0	1	6	6
9442	RAMSUND	NARVIK	1	2	0	1	6	6
9443	MYKLEBOSTAD	NARVIK	1	2	0	2	8	8
9444	HOL I TJELDSUND	NARVIK	1	2	0	2	8	8
9445	TOVIK	NARVIK	1	2	0	1	6	6
9446	GROVFJORD	NARVIK	1	2	0	2	6	6
9450	HAMNVIK	NARVIK	1	2	0	2	7	7
9453	KRÅKRØHAMN	NARVIK	1	2	0	2	8	8
9454	ÅNSTAD	NARVIK	1	2	0	2	8	8
9455	ENGENES	NARVIK	1	2	0	2	8	8
9470	GRATANGEN	NARVIK	1	2	0	2	7	7
9475	BORKENES	HARSTAD	1	2	0	1	5	5
ALTA	ALTA	ALTA	0	0	0	0	0	0
9511	ALTA	ALTA	0	0	0	0	0	0
9512	ALTA	ALTA	0	0	0	0	0	0

Postcode	Place	Terminal name	Parcels*		Business parcel express		Business groupage	
			In	Out	In	Out	In	Out
9513	ALTA	ALTA	0	0	0	0	0	0
9514	ALTA	ALTA	0	0	0	0	0	0
9515	ALTA	ALTA	0	0	0	0	0	0
9516	ALTA	ALTA	0	1	0	0	0	0
9517	ALTA	ALTA	0	2	0	0	0	0
9518	ALTA	ALTA	0	2	0	1	0	0
9519	KVIBY	ALTA	1	2	0	1	4	4
9520	KAUTOKEINO	ALTA	1	2	0	2	8	8
9522	KAUTOKEINO	ALTA	1	2	0	2	8	8
9523	KAUTOKEINO	ALTA	1	2	0	2	8	8
9524	KAUTOKEINO	ALTA	1	2	0	2	8	8
9525	MAZE	ALTA	1	2	0	2	8	8
9527	KAUTOKEINO	ALTA	1	2	0	2	8	8
9528	KAUTOKEINO	ALTA	1	2	0	2	8	8
9529	KAUTOKEINO	ALTA	1	2	0	2	8	8
9531	KVALFJORD	ALTA	1	2	0	2	8	8
9532	HAKKSTABBEN	ALTA	1	2	0	2	8	8
9533	KONGSHUS	ALTA	1	2	0	2	8	8
9536	KORSFJORDEN	ALTA	1	2	0	2	8	8
9537	TVERRELVDALEN	ALTA	1	2	0	2	8	8
9538	ALTA	ALTA	1	2	0	2	8	8
9540	TALVIK	ALTA	1	2	0	2	6	6
9541	ALTA	ALTA	1	2	0	2	6	6
9545	LANGFJORDBOTN	ALTA	1	2	0	2	8	8
9550	ØKSFJORD	ALTA	1	2	0	2	8	8

Postcode	Place	Terminal name	Parcels*		Business parcel express		Business groupage	
			In	Out	In	Out	In	Out
9552	ØKSFJORDEN	ALTA	1	2	0	2	8	8
9580	BERGSFJORD	ALTA	1	2	0	2	8	8
9582	NUVSVÅG	ALTA	1	2	0	2	8	8
9583	LANGFJORDHAMN	ALTA	1	2	0	2	8	8
9584	SØR-TVERRFJORD	ALTA	1	2	0	2	8	8
9585	SANDLAND	ALTA	1	2	0	2	8	8
9586	LOPPA	ALTA	1	2	0	2	8	8
9587	SKAVNAKK	ALTA	1	2	0	2	8	8
9590	HASVIK	ALTA	1	2	0	2	8	8
9593	BREIVIKBOTN	ALTA	1	2	0	2	8	8
9595	SØRVÆR	ALTA	1	2	0	2	8	8
9600	HAMMERFEST	ALTA	0	1	0	0	0	0
9601	HAMMERFEST	ALTA	1	2	0	2	0	0
9602	HAMMERFEST	ALTA	1	2	0	2	0	0
9603	HAMMERFEST	ALTA	1	2	0	2	0	0
9609	NORDRE SEILAND	ALTA	1	2	0	2	7	7
9610	RYPEFJORD	ALTA	0	1	0	2	0	0
9612	FORSØL	ALTA	1	2	0	2	0	0
9620	KVALSUND	ALTA	1	2	0	2	4	4
9624	REVSNESSHAMN	ALTA	1	2	0	2	8	8
9650	AKKARFJORD	ALTA	1	2	0	2	6	6
9651	LANGSTRAND	ALTA	1	2	0	2	6	6
9657	KÅRHAMN	ALTA	1	2	0	2	8	8
9664	SANDØYBOTN	ALTA	1	2	0	2	8	8
9670	TUFJORD	ALTA	1	2	0	2	8	8

Postcode	Place	Terminal name	Parcels*		Business parcel express		Business groupage	
			In	Out	In	Out	In	Out
9672	INGØY	ALTA	1	2	0	2	8	8
9690	HAVØYSUND	ALTA	1	2	0	2	8	8
9692	MÅSØY	ALTA	1	2	0	2	8	8
9700	LAKSELV	ALTA	1	2	0	2	8	8
9709	PORSANGMOEN	ALTA	1	2	0	2	8	8
9710	INDRE BILLEFJORD	ALTA	1	2	0	2	8	8
9713	RUSSENES	ALTA	1	2	0	2	8	8
9714	SNEFJORD	ALTA	1	2	0	2	8	8
9715	KOKELV	ALTA	1	2	0	2	8	8
9716	BØRSELV	ALTA	1	2	0	2	8	8
9717	VEIDNES	ALTA	1	2	0	2	8	8
9722	SKOGANVARRE	ALTA	1	2	0	2	8	8
9730	KARASJOK	ALTA	1	2	0	2	8	8
9731	KARASJOK	ALTA	1	2	0	2	8	8
9732	KARASJOK	ALTA	1	2	0	2	8	8
9733	KARASJOK	ALTA	1	2	0	2	8	8
9734	KARASJOK	ALTA	1	2	0	2	8	8
9736	KARASJOK	ALTA	1	2	0	2	8	8
9737	KARASJOK	ALTA	1	2	0	2	8	8
9740	LEBESBY	TANA	1	2	0	2	8	8
9742	KUNES	ALTA	1	2	0	2	8	8
9750	HONNINGSVÅG	ALTA	1	2	0	2	8	8
9760	NORDVÅGEN	ALTA	1	2	0	2	8	8
9762	KAMØYVÆR	ALTA	1	2	0	2	8	8
9763	SKARSVÅG	ALTA	1	2	0	2	8	8

Postcode	Place	Terminal name	Parcels*		Business parcel express		Business groupage	
			In	Out	In	Out	In	Out
9764	NORDKAPP	ALTA	1	2	0	2	8	8
9765	GJESVÆR	ALTA	1	2	0	2	8	8
9766	SARNES	ALTA	1	2	0	2	8	8
9768	REPVÅG	ALTA	1	2	0	2	8	8
9770	MEHAMN	TANA	1	2	0	2	8	8
9771	SKJÅNES	TANA	1	2	0	2	8	8
9772	LANGFJORDNES	TANA	1	2	0	2	8	8
9773	NERVEI	TANA	1	2	0	2	8	8
9775	GAMVIK	TANA	1	2	0	2	8	8
9782	DYFJORD	TANA	1	2	0	2	8	8
9790	KJØLLEFJORD	TANA	1	2	0	2	8	8
9800	VADSØ	TANA	1	2	0	2	6	6
9801	VADSØ	TANA	1	2	0	2	6	6
9802	VESTRE JAKOBSELV	TANA	1	2	0	2	5	5
9803	VADSØ	TANA	1	2	0	2	5	5
9804	VADSØ	TANA	1	2	0	2	5	5
9826	SIRMA	TANA	1	2	0	2	8	8
9840	VARANGERBOTN	TANA	1	2	0	2	5	5
9841	TANA	TANA	1	2	0	2	5	5
9842	TANA	TANA	1	2	0	2	5	5
9843	TANA	TANA	1	2	0	2	5	5
9844	TANA	TANA	0	0	0	2	5	5
9845	TANA	TANA	0	2	0	2	0	0
9900	KIRKENES	TANA	0	1	0	2	7	7
9901	KIRKENES	TANA	0	0	0	2	7	7

Postcode	Place	Terminal name	Parcels*		Business parcel express		Business groupage	
			In	Out	In	Out	In	Out
9910	BJØRNEVATN	TANA	0	1	0	2	8	8
9911	JARFJORD	TANA	0	0	0	2	8	8
9912	HESSING	TANA	0	1	0	2	7	7
9925	SVANVIK	TANA	1	2	0	2	8	8
9926	PASVIK	TANA	1	2	0	2	8	8
9930	NEIDEN	TANA	1	2	0	1	6	6
9935	BUGØYNES	TANA	1	2	0	2	6	6
9950	VARDØ	TANA	1	2	0	2	7	7
9952	VARDØ	TANA	1	2	0	2	7	7
9955	SVARTNES	TANA	1	2	0	2	7	7
9960	KIBERG	TANA	1	2	0	2	7	7
9980	BERLEVÅG	TANA	1	2	0	2	8	8
9982	KONGSFJORD	TANA	1	2	0	2	8	8
9990	BÅTSFJORD	TANA	1	2	0	2	8	8



3.3.1 Local zones Home delivery parcel plus

Postcode	Terminal	Zone in	Zone out
0001	1000	0	3
0002	1000	0	3
0003	1000	0	3
0004	1000	0	3
0005	1000	0	3
0006	1000	0	3
0007	1000	0	3
0008	1000	0	3
0009	1000	0	3
0010	1000	0	3
0011	1000	0	3
0012	1000	0	3
0013	1000	0	3
0014	1000	0	3
0015	1000	0	3
0016	1000	0	3
0017	1000	0	3
0018	1000	0	3
0019	1000	0	3
0020	1000	0	3
0021	1000	0	3
0022	1000	0	3
0023	1000	0	3
0024	1000	0	3
0025	1000	0	3
0026	1000	0	3

Postcode	Terminal	Zone in	Zone out
0027	1000	0	3
0028	1000	0	3
0029	1000	0	3
0030	1000	0	3
0031	1000	0	3
0032	1000	0	3
0033	1000	0	3
0034	1000	0	3
0035	1000	0	3
0036	1000	0	3
0037	1000	0	3
0038	1000	0	3
0039	1000	0	3
0040	1000	0	3
0041	1000	0	3
0042	1000	0	3
0043	1000	0	3
0044	1000	0	3
0045	1000	0	3
0046	1000	0	3
0047	1000	0	3
0048	1000	0	3
0049	1000	0	3
0050	1000	0	3
0051	1000	0	3
0052	1000	0	3

Postcode	Terminal	Zone in	Zone out
0053	1000	0	3
0054	1000	0	3
0055	1000	0	3
0056	1000	0	3
0057	1000	0	3
0058	1000	0	3
0059	1000	0	3
0060	1000	0	3
0061	1000	0	3
0062	1000	0	3
0063	1000	0	3
0064	1000	0	3
0065	1000	0	3
0066	1000	0	3
0067	1000	0	3
0068	1000	0	3
0069	1000	0	3
0070	1000	0	3
0071	1000	0	3
0072	1000	0	3
0073	1000	0	3
0074	1000	0	3
0075	1000	0	3
0076	1000	0	3
0077	1000	0	3
0078	1000	0	3

Postcode	Terminal	Zone in	Zone out
0079	1000	0	3
0080	1000	0	3
0081	1000	0	3
0082	1000	0	3
0083	1000	0	3
0084	1000	0	3
0085	1000	0	3
0086	1000	0	3
0087	1000	0	3
0088	1000	0	3
0089	1000	0	3
0090	1000	0	3
0091	1000	0	3
0092	1000	0	3
0093	1000	0	3
0094	1000	0	3
0095	1000	0	3
0096	1000	0	3
0097	1000	0	3
0098	1000	0	3
0099	1000	0	3
0100	1000	0	3
0101	1000	0	3
0102	1000	0	3
0103	1000	0	3
0104	1000	0	3

Postcode	Terminal	Zone in	Zone out
0105	1000	0	3
0106	1000	0	3
0107	1000	0	3
0108	1000	0	3
0109	1000	0	3
0110	1000	0	3
0111	1000	0	3
0112	1000	0	3
0113	1000	0	3
0114	1000	0	3
0115	1000	0	3
0116	1000	0	3
0117	1000	0	3
0118	1000	0	3
0119	1000	0	3
0120	1000	0	3
0121	1000	0	3
0122	1000	0	3
0123	1000	0	3
0124	1000	0	3
0125	1000	0	3
0126	1000	0	3
0127	1000	0	3
0128	1000	0	3
0129	1000	0	3
0130	1000	0	3

Postcode	Terminal	Zone in	Zone out
0131	1000	0	3
0132	1000	0	3
0133	1000	0	3
0134	1000	0	3
0135	1000	0	3
0136	1000	0	3
0137	1000	0	3
0138	1000	0	3
0139	1000	0	1
0140	1000	0	3
0141	1000	0	3
0142	1000	0	3
0143	1000	0	3
0144	1000	0	3
0145	1000	0	3
0146	1000	0	3
0147	1000	0	3
0148	1000	0	3
0149	1000	0	3
0150	1000	0	3
0151	1000	0	1
0152	1000	0	1
0153	1000	0	1
0154	1000	0	1
0155	1000	0	1
0156	1000	0	3

Postcode	Terminal	Zone in	Zone out
0157	1000	0	1
0158	1000	0	1
0159	1000	0	1
0160	1000	0	1
0161	1000	0	1
0162	1000	0	1
0163	1000	0	3
0164	1000	0	1
0165	1000	0	1
0166	1000	0	1
0167	1000	0	1
0168	1000	0	1
0169	1000	0	1
0170	1000	0	1
0171	1000	0	1
0172	1000	0	1
0173	1000	0	1
0174	1000	0	1
0175	1000	0	1
0176	1000	0	1
0177	1000	0	1
0178	1000	0	1
0179	1000	0	1
0180	1000	0	1
0181	1000	0	1
0182	1000	0	1

Postcode	Terminal	Zone in	Zone out
0183	1000	0	1
0184	1000	0	1
0185	1000	0	1
0186	1000	0	1
0187	1000	0	1
0188	1000	0	1
0189	1000	0	3
0190	1000	0	1
0191	1000	0	1
0192	1000	0	1
0193	1000	0	1
0194	1000	0	1
0195	1000	0	1
0196	1000	0	1
0197	1000	0	3
0198	1000	0	1
0199	1000	0	3
0200	1000	0	3
0201	1000	0	3
0202	1000	0	3
0203	1000	0	3
0204	1000	0	3
0205	1000	0	3
0206	1000	0	3
0207	1000	0	3
0208	1000	0	3

Postcode	Terminal	Zone in	Zone out
0209	1000	0	3
0210	1000	0	3
0211	1000	0	3
0212	1000	0	3
0213	1000	0	3
0214	1000	0	3
0215	1000	0	3
0216	1000	0	3
0217	1000	0	3
0218	1000	0	3
0219	1000	0	3
0220	1000	0	3
0221	1000	0	3
0222	1000	0	3
0223	1000	0	3
0224	1000	0	3
0225	1000	0	3
0226	1000	0	3
0227	1000	0	3
0228	1000	0	3
0229	1000	0	3
0230	1000	0	3
0231	1000	0	3
0232	1000	0	3
0233	1000	0	3
0234	1000	0	3

Postcode	Terminal	Zone in	Zone out
0235	1000	0	3
0236	1000	0	3
0237	1000	0	3
0238	1000	0	3
0239	1000	0	3
0240	1000	0	3
0241	1000	0	3
0242	1000	0	3
0243	1000	0	3
0244	1000	0	3
0245	1000	0	3
0246	1000	0	3
0247	1000	0	3
0248	1000	0	3
0249	1000	0	3
0250	1000	0	1
0251	1000	0	1
0252	1000	0	1
0253	1000	0	1
0254	1000	0	1
0255	1000	0	1
0256	1000	0	1
0257	1000	0	1
0258	1000	0	1
0259	1000	0	1
0260	1000	0	1

Postcode	Terminal	Zone in	Zone out
0261	1000	0	3
0262	1000	0	1
0263	1000	0	1
0264	1000	0	1
0265	1000	0	1
0266	1000	0	1
0267	1000	0	1
0268	1000	0	1
0269	1000	0	3
0270	1000	0	1
0271	1000	0	1
0272	1000	0	1
0273	1000	0	1
0274	1000	0	1
0275	1000	0	1
0276	1000	0	1
0277	1000	0	1
0278	1000	0	1
0279	1000	0	1
0280	1000	0	1
0281	1000	0	1
0282	1000	0	1
0283	1000	0	1
0284	1000	0	1
0285	1000	0	3
0286	1000	0	1

Postcode	Terminal	Zone in	Zone out
0287	1000	0	1
0288	1000	0	3
0289	1000	0	3
0290	1000	0	3
0291	1000	0	3
0292	1000	0	3
0293	1000	0	3
0294	1000	0	3
0295	1000	0	3
0296	1000	0	3
0297	1000	0	3
0298	1000	0	3
0299	1000	0	3
0300	1000	0	3
0301	1000	0	3
0302	1000	0	3
0303	1000	0	3
0304	1000	0	3
0305	1000	0	3
0306	1000	0	3
0307	1000	0	3
0308	1000	0	3
0309	1000	0	3
0310	1000	0	3
0311	1000	0	3
0312	1000	0	3

Postcode	Terminal	Zone in	Zone out
0313	1000	0	3
0314	1000	0	3
0315	1000	0	3
0316	1000	0	3
0317	1000	0	3
0318	1000	0	3
0319	1000	0	3
0320	1000	0	3
0321	1000	0	3
0322	1000	0	3
0323	1000	0	3
0324	1000	0	3
0325	1000	0	3
0326	1000	0	3
0327	1000	0	3
0328	1000	0	3
0329	1000	0	3
0330	1000	0	3
0331	1000	0	3
0332	1000	0	3
0333	1000	0	3
0334	1000	0	3
0335	1000	0	3
0336	1000	0	3
0337	1000	0	3
0338	1000	0	3

Postcode	Terminal	Zone in	Zone out
0339	1000	0	3
0340	1000	0	3
0341	1000	0	3
0342	1000	0	3
0343	1000	0	3
0344	1000	0	3
0345	1000	0	3
0346	1000	0	3
0347	1000	0	3
0348	1000	0	3
0349	1000	0	1
0350	1000	0	1
0351	1000	0	1
0352	1000	0	1
0353	1000	0	1
0354	1000	0	1
0355	1000	0	1
0356	1000	0	1
0357	1000	0	1
0358	1000	0	1
0359	1000	0	1
0360	1000	0	1
0361	1000	0	1
0362	1000	0	1
0363	1000	0	1
0364	1000	0	1

Postcode	Terminal	Zone in	Zone out
0365	1000	0	1
0366	1000	0	1
0367	1000	0	1
0368	1000	0	1
0369	1000	0	1
0370	1000	0	1
0371	1000	0	1
0372	1000	0	1
0373	1000	0	1
0374	1000	0	1
0375	1000	0	1
0376	1000	0	1
0377	1000	0	1
0378	1000	0	1
0379	1000	0	1
0380	1000	0	1
0381	1000	0	1
0382	1000	0	1
0383	1000	0	1
0384	1000	0	3
0385	1000	0	3
0386	1000	0	3
0387	1000	0	3
0388	1000	0	3
0389	1000	0	3
0390	1000	0	3

Postcode	Terminal	Zone in	Zone out
0391	1000	0	3
0392	1000	0	3
0393	1000	0	3
0394	1000	0	3
0395	1000	0	3
0396	1000	0	3
0397	1000	0	3
0398	1000	0	3
0399	1000	0	3
0400	1000	0	3
0401	1000	0	3
0402	1000	0	3
0403	1000	0	3
0404	1000	0	3
0405	1000	0	3
0406	1000	0	3
0407	1000	0	3
0408	1000	0	3
0409	1000	0	3
0410	1000	0	3
0411	1000	0	3
0412	1000	0	3
0413	1000	0	3
0414	1000	0	3
0415	1000	0	3
0416	1000	0	3

Postcode	Terminal	Zone in	Zone out
0417	1000	0	3
0418	1000	0	3
0419	1000	0	3
0420	1000	0	3
0421	1000	0	3
0422	1000	0	3
0423	1000	0	3
0424	1000	0	3
0425	1000	0	3
0426	1000	0	3
0427	1000	0	3
0428	1000	0	3
0429	1000	0	3
0430	1000	0	3
0431	1000	0	3
0432	1000	0	3
0433	1000	0	3
0434	1000	0	3
0435	1000	0	3
0436	1000	0	3
0437	1000	0	3
0438	1000	0	3
0439	1000	0	3
0440	1000	0	3
0441	1000	0	3
0442	1000	0	3

Postcode	Terminal	Zone in	Zone out
0443	1000	0	3
0444	1000	0	3
0445	1000	0	1
0446	1000	0	3
0447	1000	0	3
0448	1000	0	3
0449	1000	0	3
0450	1000	0	1
0451	1000	0	1
0452	1000	0	1
0453	1000	0	3
0454	1000	0	1
0455	1000	0	1
0456	1000	0	1
0457	1000	0	1
0458	1000	0	1
0459	1000	0	1
0460	1000	0	1
0461	1000	0	1
0462	1000	0	1
0463	1000	0	1
0464	1000	0	1
0465	1000	0	1
0466	1000	0	3
0467	1000	0	1
0468	1000	0	1

Postcode	Terminal	Zone in	Zone out
0469	1000	0	1
0470	1000	0	1
0471	1000	0	3
0472	1000	0	1
0473	1000	0	1
0474	1000	0	1
0475	1000	0	1
0476	1000	0	1
0477	1000	0	1
0478	1000	0	1
0479	1000	0	1
0480	1000	0	1
0481	1000	0	1
0482	1000	0	1
0483	1000	0	1
0484	1000	0	1
0485	1000	0	1
0486	1000	0	1
0487	1000	0	1
0488	1000	0	1
0489	1000	0	1
0490	1000	0	1
0491	1000	0	1
0492	1000	0	1
0493	1000	0	1
0494	1000	0	1

Postcode	Terminal	Zone in	Zone out
0495	1000	0	1
0496	1000	0	4
0497	1000	0	3
0498	1000	0	3
0499	1000	0	3
0500	1000	0	3
0501	1000	0	3
0502	1000	0	3
0503	1000	0	3
0504	1000	0	3
0505	1000	0	3
0506	1000	0	3
0507	1000	0	3
0508	1000	0	3
0509	1000	0	3
0510	1000	0	3
0511	1000	0	3
0512	1000	0	3
0513	1000	0	3
0514	1000	0	3
0515	1000	0	3
0516	1000	0	3
0517	1000	0	3
0518	1000	0	3
0519	1000	0	3
0520	1000	0	3

Postcode	Terminal	Zone in	Zone out
0521	1000	0	3
0522	1000	0	3
0523	1000	0	3
0524	1000	0	3
0525	1000	0	3
0526	1000	0	3
0527	1000	0	3
0528	1000	0	3
0529	1000	0	3
0530	1000	0	3
0531	1000	0	3
0532	1000	0	3
0533	1000	0	3
0534	1000	0	3
0535	1000	0	3
0536	1000	0	3
0537	1000	0	3
0538	1000	0	3
0539	1000	0	3
0540	1000	0	3
0541	1000	0	3
0542	1000	0	3
0543	1000	0	3
0544	1000	0	3
0545	1000	0	3
0546	1000	0	3

Postcode	Terminal	Zone in	Zone out
0547	1000	0	3
0548	1000	0	3
0549	1000	0	3
0550	1000	0	1
0551	1000	0	1
0552	1000	0	1
0553	1000	0	1
0554	1000	0	1
0555	1000	0	1
0556	1000	0	1
0557	1000	0	1
0558	1000	0	1
0559	1000	0	1
0560	1000	0	1
0561	1000	0	1
0562	1000	0	1
0563	1000	0	1
0564	1000	0	1
0565	1000	0	1
0566	1000	0	1
0567	1000	0	1
0568	1000	0	1
0569	1000	0	1
0570	1000	0	1
0571	1000	0	1
0572	1000	0	1

Postcode	Terminal	Zone in	Zone out
0573	1000	0	1
0574	1000	0	1
0575	1000	0	1
0576	1000	0	1
0577	1000	0	1
0578	1000	0	1
0579	1000	0	1
0580	1000	0	1
0581	1000	0	1
0582	1000	0	1
0583	1000	0	1
0584	1000	0	1
0585	1000	0	1
0586	1000	0	1
0587	1000	0	1
0588	1000	0	1
0589	1000	0	1
0590	1000	0	1
0591	1000	0	1
0592	1000	0	1
0593	1000	0	1
0594	1000	0	1
0595	1000	0	1
0596	1000	0	1
0597	1000	0	1
0598	1000	0	1

Postcode	Terminal	Zone in	Zone out
0599	1000	0	3
0600	1000	0	3
0601	1000	0	3
0602	1000	0	3
0603	1000	0	3
0604	1000	0	3
0605	1000	0	3
0606	1000	0	3
0607	1000	0	3
0608	1000	0	3
0609	1000	0	3
0610	1000	0	3
0611	1000	0	3
0612	1000	0	3
0613	1000	0	3
0614	1000	0	3
0615	1000	0	3
0616	1000	0	3
0617	1000	0	3
0618	1000	0	3
0619	1000	0	3
0620	1000	0	3
0621	1000	0	3
0622	1000	0	3
0623	1000	0	3
0624	1000	0	3

Postcode	Terminal	Zone in	Zone out
0625	1000	0	3
0626	1000	0	3
0627	1000	0	3
0628	1000	0	3
0629	1000	0	3
0630	1000	0	3
0631	1000	0	3
0632	1000	0	3
0633	1000	0	3
0634	1000	0	3
0635	1000	0	3
0636	1000	0	3
0637	1000	0	3
0638	1000	0	3
0639	1000	0	3
0640	1000	0	3
0641	1000	0	3
0642	1000	0	3
0643	1000	0	3
0644	1000	0	3
0645	1000	0	3
0646	1000	0	3
0647	1000	0	3
0648	1000	0	3
0649	1000	0	3
0650	1000	0	1

Postcode	Terminal	Zone in	Zone out
0651	1000	0	1
0652	1000	0	1
0653	1000	0	1
0654	1000	0	1
0655	1000	0	1
0656	1000	0	1
0657	1000	0	1
0658	1000	0	1
0659	1000	0	1
0660	1000	0	1
0661	1000	0	1
0662	1000	0	1
0663	1000	0	1
0664	1000	0	1
0665	1000	0	1
0666	1000	0	1
0667	1000	0	1
0668	1000	0	1
0669	1000	0	1
0670	1000	0	1
0671	1000	0	1
0672	1000	0	1
0673	1000	0	1
0674	1000	0	1
0675	1000	0	1
0676	1000	0	1

Postcode	Terminal	Zone in	Zone out
0677	1000	0	1
0678	1000	0	1
0679	1000	0	1
0680	1000	0	1
0681	1000	0	1
0682	1000	0	1
0683	1000	0	1
0684	1000	0	1
0685	1000	0	1
0686	1000	0	1
0687	1000	0	1
0688	1000	0	1
0689	1000	0	1
0690	1000	0	1
0691	1000	0	1
0692	1000	0	1
0693	1000	0	2
0694	1000	0	1
0695	1000	0	3
0696	1000	0	3
0697	1000	0	3
0698	1000	0	3
0699	1000	0	3
0700	1000	0	3
0701	1000	0	3
0702	1000	0	3

Postcode	Terminal	Zone in	Zone out
0703	1000	0	3
0704	1000	0	3
0705	1000	0	3
0706	1000	0	3
0707	1000	0	3
0708	1000	0	3
0709	1000	0	3
0710	1000	0	3
0711	1000	0	3
0712	1000	0	3
0713	1000	0	3
0714	1000	0	3
0715	1000	0	3
0716	1000	0	3
0717	1000	0	3
0718	1000	0	3
0719	1000	0	3
0720	1000	0	3
0721	1000	0	3
0722	1000	0	3
0723	1000	0	3
0724	1000	0	3
0725	1000	0	3
0726	1000	0	3
0727	1000	0	3
0728	1000	0	3

Postcode	Terminal	Zone in	Zone out
0729	1000	0	3
0730	1000	0	3
0731	1000	0	3
0732	1000	0	3
0733	1000	0	3
0734	1000	0	3
0735	1000	0	3
0736	1000	0	3
0737	1000	0	3
0738	1000	0	3
0739	1000	0	3
0740	1000	0	3
0741	1000	0	3
0742	1000	0	3
0743	1000	0	3
0744	1000	0	3
0745	1000	0	3
0746	1000	0	3
0747	1000	0	3
0748	1000	0	3
0749	1000	0	3
0750	1000	0	1
0751	1000	0	1
0752	1000	0	1
0753	1000	0	1
0754	1000	0	1

Postcode	Terminal	Zone in	Zone out
0755	1000	0	1
0756	1000	0	1
0757	1000	0	1
0758	1000	0	4
0759	1000	0	3
0760	1000	0	1
0761	1000	0	3
0762	1000	0	3
0763	1000	0	1
0764	1000	0	1
0765	1000	0	1
0766	1000	0	1
0767	1000	0	1
0768	1000	0	1
0769	1000	0	3
0770	1000	0	1
0771	1000	0	1
0772	1000	0	1
0773	1000	0	1
0774	1000	0	1
0775	1000	0	1
0776	1000	0	1
0777	1000	0	1
0778	1000	0	1
0779	1000	0	1
0780	1000	0	3

Postcode	Terminal	Zone in	Zone out
0781	1000	0	1
0782	1000	0	2
0783	1000	0	1
0784	1000	0	1
0785	1000	0	1
0786	1000	0	1
0787	1000	0	1
0788	1000	0	1
0789	1000	0	1
0790	1000	0	1
0791	1000	0	1
0792	1000	0	3
0793	1000	0	3
0794	1000	0	3
0795	1000	0	3
0796	1000	0	3
0797	1000	0	3
0798	1000	0	3
0799	1000	0	3
0800	1000	0	3
0801	1000	0	3
0802	1000	0	3
0803	1000	0	3
0804	1000	0	3
0805	1000	0	3
0806	1000	0	3

Postcode	Terminal	Zone in	Zone out
0807	1000	0	3
0808	1000	0	3
0809	1000	0	3
0810	1000	0	3
0811	1000	0	3
0812	1000	0	3
0813	1000	0	3
0814	1000	0	3
0815	1000	0	3
0816	1000	0	3
0817	1000	0	3
0818	1000	0	3
0819	1000	0	3
0820	1000	0	3
0821	1000	0	3
0822	1000	0	3
0823	1000	0	3
0824	1000	0	3
0825	1000	0	3
0826	1000	0	3
0827	1000	0	3
0828	1000	0	3
0829	1000	0	3
0830	1000	0	3
0831	1000	0	3
0832	1000	0	3

Postcode	Terminal	Zone in	Zone out
0833	1000	0	3
0834	1000	0	3
0835	1000	0	3
0836	1000	0	3
0837	1000	0	3
0838	1000	0	3
0839	1000	0	3
0840	1000	0	3
0841	1000	0	3
0842	1000	0	3
0843	1000	0	3
0844	1000	0	3
0845	1000	0	3
0846	1000	0	3
0847	1000	0	3
0848	1000	0	3
0849	1000	0	3
0850	1000	0	1
0851	1000	0	1
0852	1000	0	1
0853	1000	0	1
0854	1000	0	1
0855	1000	0	1
0856	1000	0	1
0857	1000	0	1
0858	1000	0	1

Postcode	Terminal	Zone in	Zone out
0859	1000	0	3
0860	1000	0	1
0861	1000	0	1
0862	1000	0	1
0863	1000	0	2
0864	1000	0	1
0865	1000	0	3
0866	1000	0	3
0867	1000	0	3
0868	1000	0	3
0869	1000	0	3
0870	1000	0	1
0871	1000	0	1
0872	1000	0	1
0873	1000	0	1
0874	1000	0	1
0875	1000	0	1
0876	1000	0	1
0877	1000	0	1
0878	1000	0	3
0879	1000	0	3
0880	1000	0	1
0881	1000	0	1
0882	1000	0	1
0883	1000	0	1
0884	1000	0	1

Postcode	Terminal	Zone in	Zone out
0885	1000	0	3
0886	1000	0	3
0887	1000	0	3
0888	1000	0	3
0889	1000	0	3
0890	1000	0	4
0891	1000	0	4
0892	1000	0	3
0893	1000	0	3
0894	1000	0	3
0895	1000	0	3
0896	1000	0	3
0897	1000	0	3
0898	1000	0	3
0899	1000	0	3
0900	1000	0	3
0901	1000	0	3
0902	1000	0	3
0903	1000	0	3
0904	1000	0	3
0905	1000	0	3
0906	1000	0	3
0907	1000	0	3
0908	1000	0	3
0909	1000	0	3
0910	1000	0	3

Postcode	Terminal	Zone in	Zone out
0911	1000	0	3
0912	1000	0	3
0913	1000	0	3
0914	1000	0	3
0915	1000	0	3
0916	1000	0	3
0917	1000	0	3
0918	1000	0	3
0919	1000	0	3
0920	1000	0	3
0921	1000	0	3
0922	1000	0	3
0923	1000	0	3
0924	1000	0	3
0925	1000	0	3
0926	1000	0	3
0927	1000	0	3
0928	1000	0	3
0929	1000	0	3
0930	1000	0	3
0931	1000	0	3
0932	1000	0	3
0933	1000	0	3
0934	1000	0	3
0935	1000	0	3
0936	1000	0	3

Postcode	Terminal	Zone in	Zone out
0937	1000	0	3
0938	1000	0	3
0939	1000	0	3
0940	1000	0	3
0941	1000	0	3
0942	1000	0	3
0943	1000	0	3
0944	1000	0	3
0945	1000	0	3
0946	1000	0	3
0947	1000	0	3
0948	1000	0	3
0949	1000	0	3
0950	1000	0	1
0951	1000	0	1
0952	1000	0	1
0953	1000	0	1
0954	1000	0	1
0955	1000	0	1
0956	1000	0	1
0957	1000	0	2
0958	1000	0	1
0959	1000	0	1
0960	1000	0	1
0961	1000	0	3
0962	1000	0	1

Postcode	Terminal	Zone in	Zone out
0963	1000	0	1
0964	1000	0	1
0965	1000	0	3
0966	1000	0	3
0967	1000	0	3
0968	1000	0	1
0969	1000	0	1
0970	1000	0	1
0971	1000	0	1
0972	1000	0	1
0973	1000	0	1
0974	1000	0	3
0975	1000	0	1
0976	1000	0	1
0977	1000	0	1
0978	1000	0	1
0979	1000	0	1
0980	1000	0	1
0981	1000	0	1
0982	1000	0	1
0983	1000	0	1
0984	1000	0	1
0985	1000	0	1
0986	1000	0	1
0987	1000	0	1
0988	1000	0	1

Postcode	Terminal	Zone in	Zone out
0989	1000	0	3
0990	1000	0	3
0991	1000	0	3
0992	1000	0	3
0993	1000	0	3
0994	1000	0	3
0995	1000	0	3
0996	1000	0	3
0997	1000	0	3
0998	1000	0	3
0999	1000	0	3
1000	1000	0	3
1001	1000	0	3
1002	1000	0	3
1003	1000	0	3
1004	1000	0	3
1005	1000	0	3
1006	1000	0	3
1007	1000	0	3
1008	1000	0	3
1009	1000	0	3
1010	1000	0	3
1011	1000	0	3
1012	1000	0	3
1013	1000	0	3
1014	1000	0	3

Postcode	Terminal	Zone in	Zone out
1015	1000	0	3
1016	1000	0	3
1017	1000	0	3
1018	1000	0	3
1019	1000	0	3
1020	1000	0	3
1021	1000	0	3
1022	1000	0	3
1023	1000	0	3
1024	1000	0	3
1025	1000	0	3
1026	1000	0	3
1027	1000	0	3
1028	1000	0	3
1029	1000	0	3
1030	1000	0	3
1031	1000	0	3
1032	1000	0	3
1033	1000	0	3
1034	1000	0	3
1035	1000	0	3
1036	1000	0	3
1037	1000	0	3
1038	1000	0	3
1039	1000	0	3
1040	1000	0	3

Postcode	Terminal	Zone in	Zone out
1041	1000	0	3
1042	1000	0	3
1043	1000	0	3
1044	1000	0	3
1045	1000	0	3
1046	1000	0	3
1047	1000	0	3
1048	1000	0	3
1049	1000	0	3
1050	1000	0	3
1051	1000	0	1
1052	1000	0	1
1053	1000	0	1
1054	1000	0	1
1055	1000	0	1
1056	1000	0	1
1057	1000	0	3
1058	1000	0	3
1059	1000	0	3
1060	1000	0	3
1061	1000	0	2
1062	1000	0	1
1063	1000	0	1
1064	1000	0	1
1065	1000	0	1
1066	1000	0	3

Postcode	Terminal	Zone in	Zone out
1067	1000	0	1
1068	1000	0	1
1069	1000	0	1
1070	1000	0	3
1071	1000	0	1
1072	1000	0	3
1073	1000	0	3
1074	1000	0	3
1075	1000	0	3
1076	1000	0	3
1077	1000	0	3
1078	1000	0	3
1079	1000	0	3
1080	1000	0	3
1081	1000	0	1
1082	1000	0	3
1083	1000	0	1
1084	1000	0	1
1085	1000	0	3
1086	1000	0	1
1087	1000	0	1
1088	1000	0	1
1089	1000	0	1
1090	1000	0	3
1091	1000	0	3
1092	1000	0	3

Postcode	Terminal	Zone in	Zone out
1093	1000	0	3
1094	1000	0	3
1095	1000	0	3
1096	1000	0	3
1097	1000	0	3
1098	1000	0	3
1099	1000	0	3
1100	1000	0	3
1101	1000	0	3
1102	1000	0	3
1103	1000	0	3
1104	1000	0	3
1105	1000	0	3
1106	1000	0	3
1107	1000	0	3
1108	1000	0	3
1109	1000	0	3
1110	1000	0	3
1111	1000	0	3
1112	1000	0	3
1113	1000	0	3
1114	1000	0	3
1115	1000	0	3
1116	1000	0	3
1117	1000	0	3
1118	1000	0	3

Postcode	Terminal	Zone in	Zone out
1119	1000	0	3
1120	1000	0	3
1121	1000	0	3
1122	1000	0	3
1123	1000	0	3
1124	1000	0	3
1125	1000	0	3
1126	1000	0	3
1127	1000	0	3
1128	1000	0	3
1129	1000	0	3
1130	1000	0	3
1131	1000	0	3
1132	1000	0	3
1133	1000	0	3
1134	1000	0	3
1135	1000	0	3
1136	1000	0	3
1137	1000	0	3
1138	1000	0	3
1139	1000	0	3
1140	1000	0	3
1141	1000	0	3
1142	1000	0	3
1143	1000	0	3
1144	1000	0	3

Postcode	Terminal	Zone in	Zone out
1145	1000	0	3
1146	1000	0	3
1147	1000	0	3
1148	1000	0	3
1149	1000	0	3
1150	1000	0	1
1151	1000	0	1
1152	1000	0	1
1153	1000	0	1
1154	1000	0	1
1155	1000	0	1
1156	1000	0	1
1157	1000	0	1
1158	1000	0	1
1159	1000	0	3
1160	1000	0	1
1161	1000	0	1
1162	1000	0	1
1163	1000	0	1
1164	1000	0	1
1165	1000	0	1
1166	1000	0	1
1167	1000	0	1
1168	1000	0	1
1169	1000	0	2
1170	1000	0	1

Postcode	Terminal	Zone in	Zone out
1171	1000	0	3
1172	1000	0	1
1173	1000	0	3
1174	1000	0	3
1175	1000	0	3
1176	1000	0	1
1177	1000	0	1
1178	1000	0	1
1179	1000	0	1
1180	1000	0	3
1181	1000	0	1
1182	1000	0	1
1183	1000	0	3
1184	1000	0	1
1185	1000	0	1
1186	1000	0	3
1187	1000	0	1
1188	1000	0	1
1189	1000	0	1
1190	1000	0	3
1191	1000	0	3
1192	1000	0	3
1193	1000	0	3
1194	1000	0	3
1195	1000	0	3
1196	1000	0	3

Postcode	Terminal	Zone in	Zone out
1197	1000	0	3
1198	1000	0	3
1199	1000	0	3
1200	1000	0	3
1201	1000	0	3
1202	1000	0	3
1203	1000	0	3
1204	1000	0	3
1205	1000	0	3
1206	1000	0	3
1207	1000	0	3
1208	1000	0	3
1209	1000	0	3
1210	1000	0	3
1211	1000	0	3
1212	1000	0	3
1213	1000	0	3
1214	1000	0	3
1215	1000	0	3
1216	1000	0	3
1217	1000	0	3
1218	1000	0	3
1219	1000	0	3
1220	1000	0	3
1221	1000	0	3
1222	1000	0	3

Postcode	Terminal	Zone in	Zone out
1223	1000	0	3
1224	1000	0	3
1225	1000	0	3
1226	1000	0	3
1227	1000	0	3
1228	1000	0	3
1229	1000	0	3
1230	1000	0	3
1231	1000	0	3
1232	1000	0	3
1233	1000	0	3
1234	1000	0	3
1235	1000	0	3
1236	1000	0	3
1237	1000	0	3
1238	1000	0	3
1239	1000	0	3
1240	1000	0	3
1241	1000	0	3
1242	1000	0	3
1243	1000	0	3
1244	1000	0	3
1245	1000	0	3
1246	1000	0	3
1247	1000	0	3
1248	1000	0	3

Postcode	Terminal	Zone in	Zone out
1249	1000	0	3
1250	1000	0	4
1251	1000	0	1
1252	1000	0	1
1253	1000	0	1
1254	1000	0	1
1255	1000	0	1
1256	1000	0	1
1257	1000	0	1
1258	1000	0	1
1259	1000	0	1
1260	1000	0	3
1261	1000	0	3
1262	1000	0	1
1263	1000	0	1
1264	1000	0	3
1265	1000	0	3
1266	1000	0	1
1267	1000	0	3
1268	1000	0	3
1269	1000	0	3
1270	1000	0	1
1271	1000	0	1
1272	1000	0	1
1273	1000	0	1
1274	1000	0	1

Postcode	Terminal	Zone in	Zone out
1275	1000	0	1
1276	1000	0	3
1277	1000	0	3
1278	1000	0	3
1279	1000	0	2
1280	1000	0	3
1281	1000	0	1
1282	1000	0	3
1283	1000	0	1
1284	1000	0	1
1285	1000	0	1
1286	1000	0	1
1287	1000	0	3
1288	1000	0	3
1289	1000	0	3
1290	1000	0	4
1291	1000	0	3
1292	1000	0	3
1293	1000	0	3
1294	1000	0	4
1295	1000	0	4
1296	1000	0	3
1297	1000	0	3
1298	1000	0	3
1299	1000	0	3
1300	1000	0	3

Postcode	Terminal	Zone in	Zone out
1301	1000	0	3
1302	1000	0	3
1303	1000	0	3
1304	1000	0	3
1305	1000	0	3
1306	1000	0	3
1307	1000	0	3
1308	1000	0	3
1309	1000	0	3
1310	1000	0	3
1311	1000	0	3
1312	1000	0	3
1313	1000	0	3
1314	1000	0	3
1315	1000	0	3
1316	1000	0	3
1317	1000	0	3
1318	1000	0	3
1319	1000	0	3
1320	1000	0	3
1321	1000	0	3
1322	1000	0	3
1323	1000	0	3
1324	1000	0	3
1325	1000	0	3
1326	1000	0	3

Postcode	Terminal	Zone in	Zone out
1327	1000	0	3
1328	1000	0	3
1329	1000	0	3
1330	1000	0	3
1331	1000	0	3
1332	1000	0	3
1333	1000	0	3
1334	1000	0	3
1335	1000	0	3
1336	1000	0	1
1337	1000	0	1
1338	1000	0	1
1339	1000	0	1
1340	1000	0	2
1341	1000	0	2
1342	1000	0	3
1343	1000	0	3
1344	1000	0	1
1345	1000	0	3
1346	1000	0	1
1347	1000	0	3
1348	1000	0	1
1349	1000	0	1
1350	1000	0	4
1351	1000	0	1
1352	1000	0	1

Postcode	Terminal	Zone in	Zone out
1353	1000	0	1
1354	1000	0	1
1355	1000	0	3
1356	1000	0	1
1357	1000	0	1
1358	1000	0	1
1359	1000	0	1
1360	1000	0	1
1361	1000	0	1
1362	1000	0	1
1363	1000	0	1
1364	1000	0	1
1365	1000	0	1
1366	1000	0	1
1367	1000	0	2
1368	1000	0	1
1369	1000	0	1
1370	1000	0	3
1371	1000	0	3
1372	1000	0	3
1373	1000	0	3
1374	1000	0	3
1375	1000	0	3
1376	1000	0	3
1377	1000	0	3
1378	1000	0	3

Postcode	Terminal	Zone in	Zone out
1379	1000	0	3
1380	1000	1	4
1381	1000	0	3
1382	1000	0	3
1383	1000	0	1
1384	1000	0	2
1385	1000	0	1
1386	1000	0	1
1387	1000	0	1
1388	1000	1	2
1389	1000	1	2
1390	1000	1	2
1391	1000	1	2
1392	1000	0	2
1393	1000	0	3
1394	1000	0	1
1395	1000	0	1
1396	1000	0	1
1397	1000	0	1
1398	1000	0	3
1399	1000	0	3
1400	1000	0	1
1401	1000	0	3
1402	1000	0	3
1403	1000	0	3
1404	1000	0	4

Postcode	Terminal	Zone in	Zone out
1405	1000	0	1
1406	1000	0	1
1407	1000	0	1
1408	1000	0	4
1409	1000	0	4
1410	1000	0	1
1411	1000	0	3
1412	1000	0	1
1413	1000	0	1
1414	1000	0	1
1415	1000	0	1
1416	1000	0	3
1417	1000	0	3
1418	1000	0	3
1419	1000	0	3
1420	1000	0	4
1421	1000	0	3
1422	1000	0	3
1423	1000	0	1
1424	1000	0	1
1425	1000	0	3
1426	1000	0	3
1427	1000	0	3
1428	1000	0	3
1429	1000	0	3
1430	1000	1	2

Postcode	Terminal	Zone in	Zone out
1431	1000	1	4
1432	1000	1	4
1433	1000	1	2
1434	1000	1	2
1435	1000	1	2
1436	1000	1	4
1437	1000	1	4
1438	1000	1	4
1439	1000	1	4
1440	1000	1	1
1441	1000	1	4
1442	1000	1	4
1443	1000	1	4
1444	1000	1	2
1445	1000	1	2
1446	1000	1	2
1447	1000	1	2
1448	1000	1	1
1449	1000	1	4
1450	1000	1	2
1451	1000	1	4
1452	1000	1	2
1453	1000	1	2
1454	1000	1	2
1455	1000	1	2
1456	1000	1	2

Postcode	Terminal	Zone in	Zone out
1457	1000	1	4
1458	1000	1	2
1459	1000	1	2
1460	1000	0	3
1461	1000	0	1
1462	1000	0	1
1463	1000	0	1
1464	1000	0	1
1465	1000	0	1
1466	1000	0	1
1467	1000	0	1
1468	1000	0	3
1469	1000	0	3
1470	1000	0	1
1471	1000	0	3
1472	1000	0	1
1473	1000	0	1
1474	1000	0	1
1475	1000	0	2
1476	1000	0	1
1477	1000	0	3
1478	1000	0	3
1479	1000	0	1
1480	1000	0	2
1481	1000	0	1
1482	1000	0	2

Postcode	Terminal	Zone in	Zone out
1483	1000	0	3
1484	1000	0	4
1485	1000	0	3
1486	1000	0	3
1487	1000	0	4
1488	1000	0	4
1489	1000	0	3
1490	1000	0	3
1491	1000	0	3
1492	1000	0	3
1493	1000	0	3
1494	1000	0	3
1495	1000	0	3
1496	1000	0	3
1497	1000	0	3
1498	1000	0	3
1499	1000	0	3
1500	1700	0	3
1501	1700	0	3
1502	1700	0	3
1503	1700	0	3
1504	1700	0	3
1505	1700	0	3
1506	1700	0	3
1507	1700	0	3
1508	1700	0	3

Postcode	Terminal	Zone in	Zone out
1509	1700	0	3
1510	1700	0	3
1511	1700	0	3
1512	1700	0	3
1513	1700	0	3
1514	1700	0	4
1515	1700	0	3
1516	1700	0	3
1517	1700	0	3
1518	1700	0	3
1519	1700	0	4
1520	1700	0	3
1521	1700	0	3
1522	1700	0	3
1523	1700	0	3
1524	1700	0	3
1525	1700	0	4
1526	1700	0	3
1527	1700	0	3
1528	1700	0	3
1529	1700	0	3
1530	1700	0	3
1531	1700	0	3
1532	1700	0	3
1533	1700	0	3
1534	1700	0	3

Postcode	Terminal	Zone in	Zone out
1535	1700	0	3
1536	1700	0	3
1537	1700	0	3
1538	1700	0	3
1539	1700	0	3
1540	1000	0	4
1541	1000	0	3
1542	1000	0	3
1543	1000	0	3
1544	1000	1	4
1545	1000	1	4
1546	1000	1	4
1547	1000	1	4
1548	1000	1	4
1549	1000	1	4
1550	1700	1	4
1551	1700	1	4
1552	1700	1	4
1553	1700	1	4
1554	1700	1	4
1555	1700	1	4
1556	1700	1	4
1557	1700	1	4
1558	1700	1	4
1559	1700	1	4
1560	1700	1	4

Postcode	Terminal	Zone in	Zone out
1561	1700	1	4
1562	1700	1	4
1563	1700	1	4
1564	1700	1	4
1565	1700	1	4
1566	1700	1	4
1567	1700	1	4
1568	1700	1	4
1569	1700	1	4
1570	1700	0	4
1571	1700	0	3
1572	1700	0	3
1573	1700	0	3
1574	1700	0	3
1575	1700	0	3
1576	1700	0	3
1577	1700	0	3
1578	1700	0	3
1579	1700	0	3
1580	1700	1	4
1581	1700	1	4
1582	1700	1	4
1583	1700	1	4
1584	1700	1	4
1585	1700	1	4
1586	1700	1	4

Postcode	Terminal	Zone in	Zone out
1587	1700	1	4
1588	1700	1	4
1589	1700	1	4
1590	1700	1	4
1591	1700	1	4
1592	1700	1	4
1593	1700	1	5
1594	1700	1	4
1595	1700	0	3
1596	1700	0	3
1597	1700	0	3
1598	1700	0	3
1599	1700	0	3
1600	1700	0	3
1601	1700	0	3
1602	1700	0	3
1603	1700	0	3
1604	1700	0	3
1605	1700	0	3
1606	1700	0	3
1607	1700	0	3
1608	1700	0	3
1609	1700	0	3
1610	1700	0	3
1611	1700	0	3
1612	1700	0	3

Postcode	Terminal	Zone in	Zone out
1613	1700	0	3
1614	1700	0	3
1615	1700	0	4
1616	1700	0	3
1617	1700	0	3
1618	1700	0	3
1619	1700	0	3
1620	1700	1	4
1621	1700	1	4
1622	1700	1	4
1623	1700	1	4
1624	1700	1	4
1625	1700	1	4
1626	1700	1	4
1627	1700	1	4
1628	1700	1	4
1629	1700	0	3
1630	1700	0	3
1631	1700	0	3
1632	1700	0	3
1633	1700	0	3
1634	1700	0	4
1635	1700	0	3
1636	1700	0	3
1637	1700	0	3
1638	1700	0	3

Postcode	Terminal	Zone in	Zone out
1639	1700	0	3
1640	1700	0	4
1641	1700	0	3
1642	1700	1	4
1643	1700	1	4
1644	1700	1	4
1645	1700	1	4
1646	1700	1	4
1647	1700	1	4
1648	1700	1	4
1649	1700	1	4
1650	1700	1	4
1651	1700	1	3
1652	1700	1	4
1653	1700	1	3
1654	1700	1	4
1655	1700	1	4
1656	1700	1	4
1657	1700	1	4
1658	1700	1	4
1659	1700	1	4
1660	1700	0	3
1661	1700	0	3
1662	1700	0	3
1663	1700	0	3
1664	1700	0	3

Postcode	Terminal	Zone in	Zone out
1665	1700	0	4
1666	1700	0	3
1667	1700	0	4
1668	1700	0	3
1669	1700	0	3
1670	1700	1	4
1671	1700	1	4
1672	1700	1	4
1673	1700	1	4
1674	1700	1	5
1675	1700	1	4
1676	1700	1	4
1677	1700	1	4
1678	1700	1	4
1679	1700	1	4
1680	1700	1	5
1681	1700	1	4
1682	1700	1	4
1683	1700	1	4
1684	1700	1	5
1685	1700	1	5
1686	1700	1	5
1687	1700	1	5
1688	1700	1	5
1689	1700	1	5
1690	1700	1	5

Postcode	Terminal	Zone in	Zone out
1691	1700	1	5
1692	1700	1	5
1693	1700	1	5
1694	1700	1	5
1695	1700	1	5
1696	1700	1	5
1697	1700	1	5
1698	1700	1	5
1699	1700	1	5
1700	1700	0	3
1701	1700	0	3
1702	1700	0	3
1703	1700	0	3
1704	1700	0	3
1705	1700	0	3
1706	1700	0	3
1707	1700	0	3
1708	1700	0	4
1709	1700	0	3
1710	1700	0	3
1711	1700	0	4
1712	1700	0	3
1713	1700	0	3
1714	1700	0	4
1715	1700	1	4
1716	1700	1	4

Postcode	Terminal	Zone in	Zone out
1717	1700	0	3
1718	1700	0	3
1719	1700	0	4
1720	1700	0	3
1721	1700	0	3
1722	1700	0	3
1723	1700	0	3
1724	1700	0	3
1725	1700	0	3
1726	1700	0	3
1727	1700	0	3
1728	1700	0	3
1729	1700	0	3
1730	1700	1	4
1731	1700	1	4
1732	1700	1	4
1733	1700	1	4
1734	1700	1	4
1735	1700	1	4
1736	1700	1	4
1737	1700	1	4
1738	1700	1	4
1739	1700	1	4
1740	1700	1	4
1741	1700	1	4
1742	1700	1	4

Postcode	Terminal	Zone in	Zone out
1743	1700	1	4
1744	1700	1	4
1745	1700	1	4
1746	1700	1	4
1747	1700	1	4
1748	1700	1	4
1749	1700	1	4
1750	1700	1	4
1751	1700	1	4
1752	1700	1	4
1753	1700	1	4
1754	1700	1	4
1755	1700	1	4
1756	1700	1	4
1757	1700	1	4
1758	1700	1	4
1759	1700	1	4
1760	1700	1	4
1761	1700	1	4
1762	1700	1	4
1763	1700	1	4
1764	1700	1	5
1765	1700	1	5
1766	1700	1	5
1767	1700	1	3
1768	1700	1	4

Postcode	Terminal	Zone in	Zone out
1769	1700	1	4
1770	1700	1	4
1771	1700	1	3
1772	1700	1	3
1773	1700	1	4
1774	1700	1	4
1775	1700	1	4
1776	1700	1	3
1777	1700	1	3
1778	1700	1	4
1779	1700	1	3
1780	1700	1	4
1781	1700	1	3
1782	1700	1	4
1783	1700	1	4
1784	1700	1	4
1785	1700	1	4
1786	1700	1	4
1787	1700	1	4
1788	1700	1	4
1789	1700	1	4
1790	1700	1	4
1791	1700	1	4
1792	1700	1	4
1793	1700	1	4
1794	1700	1	4

Postcode	Terminal	Zone in	Zone out
1795	1700	1	4
1796	1700	1	5
1797	1700	1	5
1798	1700	1	5
1799	1700	1	5
1800	1000	1	4
1801	1000	1	4
1802	1000	1	4
1803	1000	1	4
1804	1000	1	4
1805	1000	1	4
1806	1000	1	4
1807	1000	1	3
1808	1000	1	4
1809	1000	1	4
1810	1000	1	4
1811	1000	1	4
1812	1000	1	4
1813	1000	1	4
1814	1000	1	4
1815	1000	1	4
1816	1000	1	4
1817	1000	1	4
1818	1000	1	4
1819	1000	1	4
1820	1000	1	4

Postcode	Terminal	Zone in	Zone out
1821	1000	1	4
1822	1000	1	4
1823	1000	1	4
1824	1000	1	4
1825	1000	1	4
1826	1000	1	4
1827	1000	1	4
1828	1000	1	4
1829	1000	1	4
1830	1000	1	4
1831	1000	1	3
1832	1000	1	4
1833	1000	1	4
1834	1000	1	4
1835	1000	1	4
1836	1000	1	4
1837	1000	1	4
1838	1000	1	4
1839	1000	1	4
1840	1000	1	4
1841	1000	1	4
1842	1000	1	4
1843	1000	1	4
1844	1000	1	4
1845	1000	1	4
1846	1000	1	4

Postcode	Terminal	Zone in	Zone out
1847	1000	1	4
1848	1000	1	4
1849	1000	1	4
1850	1000	1	4
1851	1000	1	4
1852	1000	1	4
1853	1000	1	4
1854	1000	1	4
1855	1000	1	4
1856	1000	1	4
1857	1000	1	4
1858	1000	1	4
1859	1000	1	4
1860	1000	1	4
1861	1000	1	4
1862	1000	1	4
1863	1000	1	4
1864	1000	1	4
1865	1000	1	4
1866	1000	1	4
1867	1000	1	4
1868	1000	1	4
1869	1000	1	4
1870	1000	1	5
1871	1000	1	4
1872	1000	1	4

Postcode	Terminal	Zone in	Zone out
1873	1000	1	4
1874	1000	1	4
1875	1000	1	5
1876	1000	1	4
1877	1000	1	4
1878	1000	1	4
1879	1000	1	4
1880	1000	1	4
1881	1000	1	4
1882	1000	1	4
1883	1000	1	4
1884	1000	1	4
1885	1000	1	4
1886	1000	1	4
1887	1000	1	4
1888	1000	1	4
1889	1000	1	4
1890	1700	1	5
1891	1700	1	5
1892	1700	1	5
1893	1700	1	4
1894	1700	1	4
1895	1700	1	4
1896	1700	1	4
1897	1700	1	4
1898	1700	1	4

Postcode	Terminal	Zone in	Zone out
1899	1700	1	4
1900	1000	0	2
1901	1000	0	3
1902	1000	0	3
1903	1000	1	4
1904	1000	1	4
1905	1000	1	4
1906	1000	1	4
1907	1000	1	4
1908	1000	1	4
1909	1000	1	4
1910	1000	1	5
1911	1000	1	4
1912	1000	1	4
1913	1000	1	4
1914	1000	1	4
1915	1000	1	4
1916	1000	1	4
1917	1000	1	4
1918	1000	1	4
1919	1000	1	4
1920	1000	1	4
1921	1000	1	4
1922	1000	1	4
1923	1000	1	4
1924	1000	1	4

Postcode	Terminal	Zone in	Zone out
1925	1000	1	4
1926	1000	1	4
1927	1000	1	4
1928	1000	1	4
1929	1000	1	4
1930	1000	1	4
1931	1000	1	4
1932	1000	1	4
1933	1000	1	4
1934	1000	1	4
1935	1000	1	4
1936	1000	1	4
1937	1000	1	4
1938	1000	1	4
1939	1000	1	4
1940	1000	1	4
1941	1000	1	4
1942	1000	1	4
1943	1000	1	4
1944	1000	1	4
1945	1000	1	4
1946	1000	1	4
1947	1000	1	4
1948	1000	1	4
1949	1000	1	4
1950	1000	1	5

Postcode	Terminal	Zone in	Zone out
1951	1000	1	4
1952	1000	1	4
1953	1000	1	4
1954	1000	1	5
1955	1000	1	4
1956	1000	1	4
1957	1000	1	4
1958	1000	1	4
1959	1000	1	4
1960	1000	1	4
1961	1000	1	4
1962	1000	1	4
1963	1000	1	4
1964	1000	1	4
1965	1000	1	4
1966	1000	1	4
1967	1000	1	4
1968	1000	1	4
1969	1000	1	4
1970	1000	1	5
1971	1000	1	4
1972	1000	1	4
1973	1000	1	4
1974	1000	1	4
1975	1000	1	4
1976	1000	1	4

Postcode	Terminal	Zone in	Zone out
1977	1000	1	4
1978	1000	1	4
1979	1000	1	4
1980	1000	1	4
1981	1000	1	4
1982	1000	1	4
1983	1000	1	4
1984	1000	1	4
1985	1000	1	4
1986	1000	1	4
1987	1000	1	4
1988	1000	1	4
1989	1000	1	4
1990	1000	1	4
1991	1000	1	4
1992	1000	1	4
1993	1000	1	4
1994	1000	1	4
1995	1000	1	4
1996	1000	1	4
1997	1000	1	4
1998	1000	1	4
1999	1000	1	4
2000	1000	0	1
2001	1000	0	3
2002	1000	0	3

Postcode	Terminal	Zone in	Zone out
2003	1000	0	1
2004	1000	0	1
2005	1000	0	1
2006	1000	0	1
2007	1000	0	1
2008	1000	1	2
2009	1000	1	4
2010	1000	0	1
2011	1000	0	3
2012	1000	0	3
2013	1000	0	1
2014	1000	0	1
2015	1000	1	4
2016	1000	1	2
2017	1000	1	4
2018	1000	1	4
2019	1000	0	1
2020	1000	0	1
2021	1000	0	3
2022	1000	1	2
2023	1000	0	3
2024	1000	1	4
2025	1000	1	4
2026	1000	0	3
2027	1000	0	3
2028	1000	0	3

Postcode	Terminal	Zone in	Zone out
2029	1000	0	3
2030	1000	1	4
2031	1000	1	4
2032	1000	1	4
2033	1000	1	4
2034	1000	1	4
2035	1000	1	4
2036	1000	1	4
2037	1000	1	4
2038	1000	1	4
2039	1000	1	4
2040	1000	1	2
2041	1000	1	4
2042	1000	1	4
2043	1000	1	4
2044	1000	1	4
2045	1000	1	4
2046	1000	1	4
2047	1000	1	4
2048	1000	1	4
2049	1000	1	4
2050	1000	1	2
2051	1000	1	4
2052	1000	1	2
2053	1000	1	2
2054	1000	1	4

Postcode	Terminal	Zone in	Zone out
2055	1000	1	4
2056	1000	1	4
2057	1000	1	4
2058	1000	1	4
2059	1000	1	4
2060	1000	1	4
2061	1000	1	4
2062	1000	1	4
2063	1000	1	1
2064	1000	1	4
2065	1000	1	4
2066	1000	1	2
2067	1000	1	2
2068	1000	1	2
2069	1000	1	2
2070	1000	1	4
2071	1000	1	4
2072	1000	1	4
2073	1000	1	4
2074	1000	1	4
2075	1000	1	4
2076	1000	1	4
2077	1000	1	4
2078	1000	1	4
2079	1000	1	4
2080	1000	1	4

Postcode	Terminal	Zone in	Zone out
2081	1000	1	4
2082	1000	1	4
2083	1000	1	4
2084	1000	1	4
2085	1000	1	4
2086	1000	1	4
2087	1000	1	4
2088	1000	1	4
2089	1000	1	4
2090	1000	1	5
2091	1000	1	4
2092	1000	1	4
2093	1000	1	5
2094	1000	1	4
2095	1000	1	4
2096	1000	1	4
2097	1000	1	4
2098	1000	1	4
2099	1000	1	4
2100	2200	0	3
2101	2200	0	3
2102	2200	0	3
2103	2200	0	3
2104	2200	0	3
2105	2200	0	3
2106	2200	0	3

Postcode	Terminal	Zone in	Zone out
2107	2200	0	3
2108	2200	0	3
2109	2200	0	3
2110	2200	1	5
2111	2200	1	4
2112	2200	1	4
2113	2200	1	4
2114	2200	1	5
2115	2200	1	4
2116	2200	1	5
2117	2200	1	4
2118	2200	1	4
2119	2200	1	4
2120	2200	1	4
2121	2200	1	4
2122	2200	1	4
2123	2200	1	5
2124	2200	1	4
2125	2200	1	4
2126	2200	1	4
2127	2200	1	4
2128	2200	1	4
2129	2200	1	4
2130	2200	1	5
2131	2200	1	4
2132	2200	1	4

Postcode	Terminal	Zone in	Zone out
2133	2200	1	4
2134	2200	1	5
2135	2200	1	4
2136	2200	1	4
2137	2200	1	4
2138	2200	1	4
2139	2200	1	4
2140	2200	1	4
2141	2200	1	4
2142	2200	1	4
2143	2200	1	4
2144	2200	1	4
2145	2200	1	4
2146	2200	1	4
2147	2200	1	4
2148	2200	1	4
2149	2200	1	4
2150	1000	1	4
2151	1000	1	4
2152	1000	1	4
2153	1000	1	4
2154	1000	1	4
2155	1000	1	4
2156	1000	1	4
2157	1000	1	4
2158	1000	1	4

Postcode	Terminal	Zone in	Zone out
2159	1000	1	4
2160	1000	1	4
2161	1000	1	4
2162	1000	1	4
2163	1000	1	4
2164	1000	1	5
2165	1000	1	4
2166	1000	1	4
2167	1000	1	4
2168	1000	1	4
2169	1000	1	4
2170	1000	1	4
2171	1000	1	4
2172	1000	1	4
2173	1000	1	4
2174	1000	1	4
2175	1000	1	4
2176	1000	1	4
2177	1000	1	4
2178	1000	1	4
2179	1000	1	4
2180	2200	1	4
2181	2200	1	4
2182	2200	1	4
2183	2200	1	4
2184	2200	1	4

Postcode	Terminal	Zone in	Zone out
2185	2200	1	4
2186	2200	1	4
2187	2200	1	4
2188	2200	1	4
2189	2200	1	4
2190	2200	1	4
2191	2200	1	4
2192	2200	1	4
2193	2200	1	4
2194	2200	1	4
2195	2200	1	4
2196	2200	1	4
2197	2200	1	4
2198	2200	1	4
2199	2200	1	4
2200	2200	0	3
2201	2200	0	3
2202	2200	0	3
2203	2200	0	3
2204	2200	0	3
2205	2200	0	3
2206	2200	0	3
2207	2200	0	3
2208	2200	0	4
2209	2200	0	4
2210	2200	0	4

Postcode	Terminal	Zone in	Zone out
2211	2200	0	4
2212	2200	0	3
2213	2200	0	4
2214	2200	0	3
2215	2200	0	3
2216	2200	1	4
2217	2200	1	5
2218	2200	1	5
2219	2200	1	5
2220	2200	1	5
2221	2200	1	4
2222	2200	1	4
2223	2200	1	5
2224	2200	1	5
2225	2200	0	3
2226	2200	0	3
2227	2200	0	3
2228	2200	0	3
2229	2200	0	3
2230	2200	1	4
2231	2200	1	4
2232	2200	1	5
2233	2200	1	5
2234	2200	1	4
2235	2200	1	4
2236	2200	1	4

Postcode	Terminal	Zone in	Zone out
2237	2200	1	4
2238	2200	1	4
2239	2200	1	4
2240	2200	1	4
2241	2200	1	4
2242	2200	1	4
2243	2200	1	4
2244	2200	1	4
2245	2200	1	4
2246	2200	1	4
2247	2200	1	4
2248	2200	1	4
2249	2200	1	4
2250	2200	1	5
2251	2200	1	5
2252	2200	1	5
2253	2200	1	5
2254	2200	1	5
2255	2200	1	5
2256	2200	1	5
2257	2200	1	5
2258	2200	1	5
2259	2200	1	5
2260	2200	1	4
2261	2200	1	4
2262	2200	1	4

Postcode	Terminal	Zone in	Zone out
2263	2200	1	4
2264	2200	1	4
2265	2200	1	5
2266	2200	1	5
2267	2200	1	4
2268	2200	1	4
2269	2200	1	4
2270	2200	1	4
2271	2200	1	4
2272	2200	1	4
2273	2200	1	4
2274	2200	1	4
2275	2200	1	4
2276	2200	1	4
2277	2200	1	4
2278	2200	1	4
2279	2200	1	4
2280	2200	1	5
2281	2200	1	4
2282	2200	1	5
2283	2200	1	5
2284	2200	1	5
2285	2200	1	5
2286	2200	1	5
2287	2200	1	5
2288	2200	1	5

Postcode	Terminal	Zone in	Zone out
2289	2200	1	5
2290	2200	1	5
2291	2200	1	5
2292	2200	1	5
2293	2200	1	5
2294	2200	1	5
2295	2200	1	5
2296	2200	1	5
2297	2200	1	5
2298	2200	1	5
2299	2200	1	5
2300	2300	0	3
2301	2300	0	3
2302	2300	0	3
2303	2300	0	3
2304	2300	0	3
2305	2300	0	3
2306	2300	0	3
2307	2300	0	3
2308	2300	0	3
2309	2300	0	3
2310	2300	0	3
2311	2300	0	3
2312	2300	0	4
2313	2300	0	3
2314	2300	0	3

Postcode	Terminal	Zone in	Zone out
2315	2300	0	3
2316	2300	0	3
2317	2300	0	3
2318	2300	0	3
2319	2300	0	3
2320	2300	0	3
2321	2300	0	3
2322	2300	0	4
2323	2300	0	4
2324	2300	1	5
2325	2300	0	3
2326	2300	0	3
2327	2300	0	3
2328	2300	0	3
2329	2300	0	3
2330	2300	1	5
2331	2300	1	4
2332	2300	1	4
2333	2300	1	4
2334	2300	1	4
2335	2300	0	4
2336	2300	0	3
2337	2300	1	4
2338	2300	1	4
2339	2300	1	4
2340	2300	1	4

Postcode	Terminal	Zone in	Zone out
2341	2300	1	4
2342	2300	1	4
2343	2300	1	4
2344	2300	1	4
2345	2300	1	4
2346	2300	1	4
2347	2300	1	4
2348	2300	1	4
2349	2300	1	4
2350	2300	1	4
2351	2300	1	4
2352	2300	1	4
2353	2300	1	4
2354	2300	1	4
2355	2300	1	4
2356	2300	1	4
2357	2300	1	4
2358	2300	1	4
2359	2300	1	4
2360	2300	1	4
2361	2300	1	4
2362	2300	1	4
2363	2300	1	4
2364	2300	1	4
2365	2300	1	5
2366	2300	1	4

Postcode	Terminal	Zone in	Zone out
2367	2300	1	4
2368	2300	1	4
2369	2300	1	4
2370	2300	1	4
2371	2300	1	4
2372	2300	1	4
2373	2300	1	4
2374	2300	1	4
2375	2300	1	4
2376	2300	1	4
2377	2300	1	4
2378	2300	1	4
2379	2300	1	4
2380	2300	0	3
2381	2300	0	3
2382	2300	0	3
2383	2300	0	3
2384	2300	0	4
2385	2300	0	4
2386	2300	0	4
2387	2300	0	4
2388	2300	0	4
2389	2300	0	3
2390	2300	1	4
2391	2300	1	4
2392	2300	1	4

Postcode	Terminal	Zone in	Zone out
2393	2300	1	4
2394	2300	1	4
2395	2300	1	4
2396	2300	1	4
2397	2300	1	4
2398	2300	1	4
2399	2300	1	4
2400	2300	1	4
2401	2300	1	4
2402	2300	1	4
2403	2300	1	4
2404	2300	1	4
2405	2300	1	4
2406	2300	1	4
2407	2300	1	4
2408	2300	1	4
2409	2300	1	4
2410	2300	1	5
2411	2300	1	4
2412	2300	1	5
2413	2300	1	4
2414	2300	1	4
2415	2300	1	5
2416	2300	1	5
2417	2300	1	4
2418	2300	1	4

Postcode	Terminal	Zone in	Zone out
2419	2300	1	4
2420	2300	1	4
2421	2300	1	4
2422	2300	1	5
2423	2300	1	5
2424	2300	1	5
2425	2300	1	5
2426	2300	1	5
2427	2300	1	5
2428	2300	1	5
2429	2300	1	5
2430	2300	1	5
2431	2300	1	5
2432	2300	1	5
2433	2300	1	5
2434	2200	1	5
2435	2200	1	5
2436	2200	1	5
2437	2200	1	5
2438	2300	1	5
2439	2200	1	4
2440	2300	1	5
2441	2300	1	5
2442	2300	1	5
2443	2300	1	5
2444	2300	1	5

Postcode	Terminal	Zone in	Zone out
2445	2300	1	5
2446	2300	1	5
2447	2300	1	5
2448	2300	1	5
2449	2300	1	5
2450	2300	1	5
2451	2300	1	4
2452	2300	1	4
2453	2300	1	4
2454	2300	1	4
2455	2300	1	4
2456	2300	1	4
2457	2300	1	4
2458	2300	1	4
2459	2300	1	4
2460	2300	1	5
2461	2300	1	5
2462	2300	1	5
2463	2300	1	5
2464	2300	1	5
2465	2300	1	5
2466	2300	1	5
2467	2300	1	5
2468	2300	1	5
2469	2300	1	5
2470	2300	1	5

Postcode	Terminal	Zone in	Zone out
2471	2300	1	5
2472	2300	1	5
2473	2300	1	5
2474	2300	1	5
2475	2300	1	5
2476	2300	1	5
2477	2300	1	5
2478	2300	1	5
2479	2300	1	5
2480	2300	1	5
2481	2300	1	5
2482	2300	1	5
2483	2300	1	5
2484	2300	1	5
2485	2300	1	5
2486	2300	1	5
2487	2300	1	5
2488	2300	1	5
2489	2300	1	5
2490	2300	1	5
2491	2300	1	5
2492	2300	1	5
2493	2300	1	5
2494	2300	1	5
2495	2300	1	5
2496	2300	1	5

Postcode	Terminal	Zone in	Zone out
2497	2300	1	5
2498	2300	1	5
2499	2300	1	5
2500	2300	1	5
2501	2300	1	5
2502	2300	1	5
2503	2300	1	5
2504	2300	1	5
2505	2300	1	5
2506	2300	1	5
2507	2300	1	5
2508	2300	1	5
2509	2300	1	5
2510	2300	1	5
2511	2300	1	5
2512	2300	1	5
2513	2300	1	5
2514	2300	1	5
2515	2300	1	5
2516	2300	1	5
2517	2300	1	5
2518	2300	1	5
2519	2300	1	5
2520	2300	1	5
2521	2300	1	5
2522	2300	1	5

Postcode	Terminal	Zone in	Zone out
2523	2300	1	5
2524	2300	1	5
2525	2300	1	5
2526	2300	1	5
2527	2300	1	5
2528	2300	1	5
2529	2300	1	5
2530	2300	1	5
2531	2300	1	5
2532	2300	1	5
2533	2300	1	5
2534	2300	1	5
2535	2300	1	5
2536	2300	1	5
2537	2300	1	5
2538	2300	1	5
2539	2300	1	5
2540	2300	1	5
2541	2300	1	5
2542	2300	1	5
2543	2300	1	5
2544	2300	1	5
2545	2300	1	5
2546	2300	1	5
2547	2300	1	5
2548	2300	1	5

Postcode	Terminal	Zone in	Zone out
2549	2300	1	5
2550	2300	1	5
2551	2300	1	5
2552	2300	1	5
2553	2300	1	5
2554	2300	1	5
2555	2300	1	5
2556	2300	1	5
2557	2300	1	5
2558	2300	1	5
2559	2300	1	5
2560	2300	1	5
2561	2300	1	5
2562	2300	1	5
2563	2300	1	5
2564	2300	1	5
2565	2300	1	5
2566	2300	1	5
2567	2300	1	5
2568	2300	1	5
2569	2300	1	5
2570	2300	1	5
2571	2300	1	5
2572	2300	1	5
2573	2300	1	5
2574	2300	1	5

Postcode	Terminal	Zone in	Zone out
2575	2300	1	5
2576	2300	1	5
2577	2300	1	5
2578	2300	1	5
2579	2300	1	5
2580	2300	1	5
2581	2300	1	5
2582	2300	1	5
2583	2300	1	5
2584	2300	1	5
2585	2300	1	5
2586	2300	1	5
2587	2300	1	5
2588	2300	1	5
2589	2300	1	5
2590	2300	1	5
2591	2300	1	5
2592	2300	1	5
2593	2300	1	5
2594	2300	1	5
2595	2300	1	5
2596	2300	1	5
2597	2300	1	5
2598	2300	1	5
2599	2300	1	5
2600	2300	1	4

Postcode	Terminal	Zone in	Zone out
2601	2300	1	4
2602	2300	1	4
2603	2300	1	4
2604	2300	1	4
2605	2300	1	4
2606	2300	1	4
2607	2300	1	5
2608	2300	1	4
2609	2300	1	4
2610	2300	1	5
2611	2300	1	4
2612	2300	1	5
2613	2300	1	3
2614	2300	1	4
2615	2300	1	3
2616	2300	1	5
2617	2300	1	4
2618	2300	1	4
2619	2300	1	3
2620	2300	1	4
2621	2300	1	4
2622	2300	1	4
2623	2300	1	4
2624	2300	1	4
2625	2300	1	4
2626	2300	1	4

Postcode	Terminal	Zone in	Zone out
2627	2300	1	4
2628	2300	1	4
2629	2300	1	4
2630	2670	1	4
2631	2670	1	4
2632	2670	1	5
2633	2670	1	4
2634	2670	1	5
2635	2300	1	4
2636	2300	1	4
2637	2300	1	4
2638	2300	1	4
2639	2670	1	4
2640	2670	1	4
2641	2670	1	4
2642	2670	1	5
2643	2670	1	5
2644	2670	1	4
2645	2670	1	4
2646	2670	1	5
2647	2670	1	5
2648	2670	1	4
2649	2300	1	5
2650	2300	1	5
2651	2300	1	5
2652	2300	1	5

Postcode	Terminal	Zone in	Zone out
2653	2300	1	5
2654	2300	1	5
2655	2300	1	5
2656	2300	1	5
2657	2300	1	5
2658	2300	1	5
2659	2670	1	4
2660	2670	1	5
2661	2670	1	5
2662	2670	1	5
2663	2670	1	5
2664	2670	1	4
2665	2670	1	5
2666	2670	1	5
2667	2670	1	5
2668	2670	1	5
2669	2670	1	5
2670	2670	0	4
2671	2670	0	3
2672	2670	0	4
2673	2670	1	5
2674	2670	1	5
2675	2670	0	3
2676	2670	1	5
2677	2670	1	5
2678	2670	1	4

Postcode	Terminal	Zone in	Zone out
2679	2670	1	4
2680	2670	1	4
2681	2670	1	4
2682	2670	1	5
2683	2670	1	5
2684	2670	1	4
2685	2670	1	5
2686	2670	1	5
2687	2670	1	5
2688	2670	1	4
2689	2670	1	4
2690	2670	1	5
2691	2670	1	5
2692	2670	1	5
2693	2670	1	5
2694	2670	1	5
2695	2670	1	5
2696	2670	1	5
2697	2670	1	5
2698	2670	1	5
2699	2670	1	5
2700	1000	1	4
2701	1000	1	4
2702	1000	1	4
2703	1000	1	4
2704	1000	1	4

Postcode	Terminal	Zone in	Zone out
2705	1000	1	4
2706	1000	1	4
2707	1000	1	4
2708	1000	1	4
2709	1000	1	4
2710	1000	1	4
2711	1000	1	4
2712	1000	1	4
2713	1000	1	4
2714	1000	1	4
2715	1000	1	4
2716	1000	1	4
2717	1000	1	4
2718	1000	1	4
2719	1000	1	4
2720	1000	1	4
2721	1000	1	4
2722	1000	1	4
2723	1000	1	4
2724	1000	1	4
2725	1000	1	4
2726	1000	1	4
2727	1000	1	4
2728	1000	1	4
2729	1000	1	4
2730	1000	1	4

Postcode	Terminal	Zone in	Zone out
2731	1000	1	4
2732	1000	1	4
2733	1000	1	4
2734	1000	1	4
2735	1000	1	4
2736	1000	1	4
2737	1000	1	4
2738	1000	1	4
2739	1000	1	4
2740	1000	1	4
2741	1000	1	4
2742	1000	1	4
2743	1000	1	4
2744	1000	1	4
2745	1000	1	4
2746	1000	1	4
2747	1000	1	4
2748	1000	1	4
2749	1000	1	4
2750	1000	1	4
2751	1000	1	4
2752	1000	1	4
2753	1000	1	4
2754	1000	1	4
2755	1000	1	4
2756	1000	1	4

Postcode	Terminal	Zone in	Zone out
2757	1000	1	4
2758	1000	1	4
2759	1000	1	4
2760	1000	1	4
2761	1000	1	4
2762	1000	1	4
2763	1000	1	4
2764	1000	1	4
2765	1000	1	4
2766	1000	1	4
2767	1000	1	4
2768	1000	1	4
2769	1000	1	4
2770	1000	1	4
2771	1000	1	4
2772	1000	1	4
2773	1000	1	4
2774	1000	1	4
2775	1000	1	4
2776	1000	1	4
2777	1000	1	4
2778	1000	1	4
2779	1000	1	4
2780	1000	1	4
2781	1000	1	4
2782	1000	1	4

Postcode	Terminal	Zone in	Zone out
2783	1000	1	4
2784	1000	1	4
2785	1000	1	4
2786	1000	1	4
2787	1000	1	4
2788	1000	1	4
2789	1000	1	4
2790	1000	1	4
2791	1000	1	4
2792	1000	1	4
2793	1000	1	4
2794	1000	1	4
2795	1000	1	4
2796	1000	1	4
2797	1000	1	4
2798	1000	1	4
2799	1000	1	4
2800	2300	1	4
2801	2300	1	4
2802	2300	1	4
2803	2300	1	4
2804	2300	1	4
2805	2300	1	4
2806	2300	1	4
2807	2300	1	4
2808	2300	1	4

Postcode	Terminal	Zone in	Zone out
2809	2300	1	4
2810	2300	1	4
2811	2300	1	4
2812	2300	1	4
2813	2300	1	4
2814	2300	1	4
2815	2300	1	3
2816	2300	1	4
2817	2300	1	4
2818	2300	1	4
2819	2300	1	4
2820	2300	1	4
2821	2300	1	4
2822	2300	1	4
2823	2300	1	4
2824	2300	1	4
2825	2300	1	5
2826	2300	1	4
2827	2300	1	4
2828	2300	1	4
2829	2300	1	4
2830	2300	1	4
2831	2300	1	4
2832	2300	1	4
2833	2300	1	4
2834	2300	1	4

Postcode	Terminal	Zone in	Zone out
2835	2300	1	4
2836	2300	1	4
2837	2300	1	4
2838	2300	1	5
2839	2300	1	5
2840	2300	1	5
2841	2300	1	5
2842	2300	1	4
2843	2300	1	4
2844	2300	1	4
2845	2300	1	4
2846	2300	1	4
2847	2300	1	4
2848	2300	1	4
2849	2300	1	4
2850	2300	1	4
2851	2300	1	4
2852	2300	1	4
2853	2300	1	5
2854	2300	1	4
2855	2300	1	4
2856	2300	1	4
2857	2300	1	4
2858	2300	1	4
2859	2300	1	4
2860	2300	1	5

Postcode	Terminal	Zone in	Zone out
2861	2300	1	5
2862	2300	1	5
2863	2300	1	4
2864	2300	1	4
2865	2300	1	4
2866	2300	1	5
2867	2300	1	4
2868	2300	1	4
2869	2300	1	4
2870	2300	1	4
2871	2300	1	4
2872	2300	1	4
2873	2300	1	4
2874	2300	1	4
2875	2300	1	4
2876	2300	1	4
2877	2300	1	4
2878	2300	1	4
2879	2300	1	4
2880	2300	1	5
2881	2300	1	5
2882	2300	1	4
2883	2300	1	4
2884	2300	1	4
2885	2300	1	4
2886	2300	1	4

Postcode	Terminal	Zone in	Zone out
2887	2300	1	4
2888	2300	1	4
2889	2300	1	4
2890	2300	1	5
2891	2300	1	5
2892	2300	1	5
2893	2300	1	5
2894	2300	1	5
2895	2300	1	5
2896	2300	1	5
2897	2300	1	5
2898	2300	1	5
2899	2300	1	5
2900	2300	1	4
2901	2300	1	4
2902	2300	1	4
2903	2300	1	4
2904	2300	1	4
2905	2300	1	4
2906	2300	1	4
2907	2300	1	4
2908	2300	1	4
2909	2300	1	4
2910	2300	1	5
2911	2300	1	4
2912	2300	1	4

Postcode	Terminal	Zone in	Zone out
2913	2300	1	4
2914	2300	1	5
2915	2300	1	5
2916	2300	1	5
2917	2300	1	5
2918	2300	1	5
2919	2300	1	5
2920	2300	1	4
2921	2300	1	4
2922	2300	1	5
2923	2300	1	5
2924	2300	1	5
2925	2300	1	5
2926	2300	1	4
2927	2300	1	4
2928	2300	1	4
2929	2300	1	4
2930	2300	1	5
2931	2300	1	4
2932	2300	1	4
2933	2300	1	5
2934	2300	1	4
2935	2300	1	5
2936	2300	1	5
2937	2300	1	5
2938	2300	1	5

Postcode	Terminal	Zone in	Zone out
2939	2300	1	5
2940	2300	1	5
2941	2300	1	5
2942	2300	1	5
2943	2300	1	5
2944	2300	1	5
2945	2300	1	4
2946	2300	1	4
2947	2300	1	4
2948	2300	1	4
2949	2300	1	4
2950	2300	1	5
2951	2300	1	5
2952	2300	1	5
2953	2300	1	5
2954	2300	1	5
2955	2300	1	5
2956	2300	1	5
2957	2300	1	5
2958	2300	1	5
2959	2300	1	5
2960	2300	1	5
2961	2300	1	5
2962	2300	1	5
2963	2300	1	5
2964	2300	1	5

Postcode	Terminal	Zone in	Zone out
2965	2300	1	5
2966	2300	1	5
2967	2300	1	5
2968	2300	1	5
2969	2300	1	5
2970	2300	1	5
2971	2300	1	5
2972	2300	1	5
2973	2300	1	5
2974	2300	1	5
2975	2300	1	5
2976	2300	1	5
2977	2300	1	5
2978	2300	1	5
2979	2300	1	5
2980	2300	1	5
2981	2300	1	5
2982	2300	1	5
2983	2300	1	5
2984	2300	1	5
2985	2300	1	5
2986	2300	1	5
2987	2300	1	5
2988	2300	1	5
2989	2300	1	5
2990	2300	1	5

Postcode	Terminal	Zone in	Zone out
2991	2300	1	5
2992	2300	1	5
2993	2300	1	5
2994	2300	1	5
2995	2300	1	5
2996	2300	1	5
2997	2300	1	5
2998	2300	1	5
2999	2300	1	5
3000	3000	0	3
3001	3000	0	3
3002	3000	0	3
3003	3000	0	3
3004	3000	0	3
3005	3000	0	3
3006	3000	0	3
3007	3000	0	3
3008	3000	0	3
3009	3000	0	3
3010	3000	0	3
3011	3000	0	3
3012	3000	0	3
3013	3000	0	3
3014	3000	0	4
3015	3000	0	3
3016	3000	0	3

Postcode	Terminal	Zone in	Zone out
3017	3000	0	3
3018	3000	0	3
3019	3000	0	3
3020	3000	0	3
3021	3000	0	4
3022	3000	0	3
3023	3000	0	3
3024	3000	0	3
3025	3000	0	3
3026	3000	0	3
3027	3000	0	3
3028	3000	0	3
3029	3000	0	3
3030	3000	0	3
3031	3000	0	4
3032	3000	0	3
3033	3000	0	3
3034	3000	0	3
3035	3000	0	3
3036	3000	0	3
3037	3000	0	4
3038	3000	0	3
3039	3000	0	4
3040	3000	0	3
3041	3000	0	3
3042	3000	0	4

Postcode	Terminal	Zone in	Zone out
3043	3000	0	3
3044	3000	0	3
3045	3000	0	3
3046	3000	0	3
3047	3000	0	3
3048	3000	0	3
3049	3000	0	3
3050	3000	1	4
3051	3000	1	4
3052	3000	1	4
3053	3000	1	4
3054	3000	1	4
3055	3000	1	4
3056	3000	1	4
3057	3000	1	4
3058	3000	1	4
3059	3000	1	4
3060	3000	1	4
3061	3000	1	4
3062	3000	1	4
3063	3000	1	4
3064	3000	1	4
3065	3000	1	4
3066	3000	1	4
3067	3000	1	4
3068	3000	1	4

Postcode	Terminal	Zone in	Zone out
3069	3000	1	4
3070	3000	1	4
3071	3000	1	4
3072	3000	1	4
3073	3000	1	4
3074	3000	1	4
3075	3000	1	4
3076	3000	1	4
3077	3000	1	4
3078	3000	1	4
3079	3000	1	4
3080	3000	1	4
3081	3000	1	4
3082	3000	1	4
3083	3000	1	4
3084	3000	1	4
3085	3000	1	4
3086	3000	1	4
3087	3000	1	4
3088	3000	1	4
3089	3000	1	4
3090	3000	1	5
3091	3000	1	5
3092	3000	1	5
3093	3000	1	5
3094	3000	1	5

Postcode	Terminal	Zone in	Zone out
3095	3000	1	5
3096	3000	1	5
3097	3000	1	5
3098	3000	1	5
3099	3000	1	5
3100	3200	0	3
3101	3200	0	3
3102	3200	0	3
3103	3200	0	3
3104	3200	0	3
3105	3200	0	3
3106	3200	0	3
3107	3200	0	3
3108	3200	0	3
3109	3200	0	3
3110	3200	0	3
3111	3200	0	3
3112	3200	0	3
3113	3200	0	3
3114	3200	0	4
3115	3200	0	3
3116	3200	0	3
3117	3200	0	3
3118	3200	0	3
3119	3200	0	3
3120	3200	1	4

Postcode	Terminal	Zone in	Zone out
3121	3200	1	4
3122	3200	0	3
3123	3200	0	3
3124	3200	0	3
3125	3200	0	3
3126	3200	0	3
3127	3200	0	3
3128	3200	1	4
3129	3200	0	3
3130	3200	0	3
3131	3200	1	4
3132	3200	1	4
3133	3200	1	4
3134	3200	1	4
3135	3200	0	4
3136	3200	0	3
3137	3200	0	3
3138	3200	0	3
3139	3200	0	3
3140	3200	0	4
3141	3200	0	3
3142	3200	0	3
3143	3200	0	4
3144	3200	1	5
3145	3200	1	4
3146	3200	1	4

Postcode	Terminal	Zone in	Zone out
3147	3200	1	4
3148	3200	1	5
3149	3200	1	5
3150	3200	0	4
3151	3200	0	3
3152	3200	0	3
3153	3200	0	4
3154	3200	0	3
3155	3200	0	3
3156	3200	0	3
3157	3200	0	3
3158	3200	0	4
3159	3200	0	4
3160	3200	0	3
3161	3200	0	3
3162	3200	0	3
3163	3200	0	3
3164	3200	0	3
3165	3200	1	4
3166	3200	0	3
3167	3200	0	3
3168	3200	0	3
3169	3200	0	3
3170	3200	0	3
3171	3200	0	4
3172	3200	0	3

Postcode	Terminal	Zone in	Zone out
3173	3200	0	3
3174	3200	0	4
3175	3200	0	4
3176	3200	0	4
3177	3200	0	3
3178	3200	0	4
3179	3200	0	3
3180	3200	0	4
3181	3200	0	3
3182	3200	0	3
3183	3200	0	3
3184	3200	0	4
3185	3200	0	3
3186	3200	0	3
3187	3200	0	3
3188	3200	0	3
3189	3200	0	4
3190	3200	0	3
3191	3200	0	3
3192	3200	0	3
3193	3200	0	3
3194	3200	0	3
3195	3200	0	3
3196	3200	0	3
3197	3200	0	3
3198	3200	0	3

Postcode	Terminal	Zone in	Zone out
3199	3200	0	3
3200	3200	0	3
3201	3200	0	3
3202	3200	0	3
3203	3200	0	3
3204	3200	0	3
3205	3200	0	3
3206	3200	0	3
3207	3200	0	3
3208	3200	0	3
3209	3200	0	3
3210	3200	0	3
3211	3200	0	3
3212	3200	0	3
3213	3200	0	3
3214	3200	0	3
3215	3200	0	3
3216	3200	0	3
3217	3200	0	3
3218	3200	0	3
3219	3200	0	3
3220	3200	0	4
3221	3200	0	3
3222	3200	0	3
3223	3200	0	3
3224	3200	0	3

Postcode	Terminal	Zone in	Zone out
3225	3200	0	3
3226	3200	0	3
3227	3200	0	3
3228	3200	0	4
3229	3200	0	3
3230	3200	0	3
3231	3200	0	4
3232	3200	0	3
3233	3200	0	4
3234	3200	0	4
3235	3200	0	3
3236	3200	0	3
3237	3200	0	4
3238	3200	0	3
3239	3200	0	4
3240	3200	0	3
3241	3200	0	3
3242	3200	0	4
3243	3200	0	4
3244	3200	0	3
3245	3200	0	3
3246	3200	0	3
3247	3200	0	3
3248	3200	0	3
3249	3200	0	3
3250	3200	0	3

Postcode	Terminal	Zone in	Zone out
3251	3200	0	3
3252	3200	0	3
3253	3200	0	3
3254	3200	0	3
3255	3200	0	3
3256	3200	0	3
3257	3200	0	3
3258	3200	0	3
3259	3200	0	3
3260	3200	0	3
3261	3200	0	4
3262	3200	0	3
3263	3200	0	3
3264	3200	0	3
3265	3200	0	3
3266	3200	0	3
3267	3200	0	4
3268	3200	0	4
3269	3200	0	3
3270	3200	0	4
3271	3200	0	3
3272	3200	0	3
3273	3200	0	3
3274	3200	0	3
3275	3200	1	5
3276	3200	1	4

Postcode	Terminal	Zone in	Zone out
3277	3200	1	4
3278	3200	1	4
3279	3200	1	4
3280	3200	0	4
3281	3200	0	3
3282	3200	0	4
3283	3200	0	3
3284	3200	0	3
3285	3200	0	3
3286	3200	0	3
3287	3200	0	3
3288	3200	0	3
3289	3200	0	3
3290	3200	1	4
3291	3200	1	4
3292	3200	1	4
3293	3200	1	4
3294	3200	1	4
3295	3200	1	4
3296	3200	1	4
3297	3200	1	4
3298	3200	1	4
3299	3200	1	4
3300	3000	1	4
3301	3000	1	4
3302	3000	1	4

Postcode	Terminal	Zone in	Zone out
3303	3000	1	4
3304	3000	1	4
3305	3000	1	4
3306	3000	1	4
3307	3000	1	4
3308	3000	1	4
3309	3000	1	4
3310	3000	1	4
3311	3000	1	4
3312	3000	1	4
3313	3000	1	4
3314	3000	1	4
3315	3000	1	4
3316	3000	1	4
3317	3000	1	4
3318	3000	1	4
3319	3000	1	4
3320	3000	1	4
3321	3000	1	4
3322	3000	1	5
3323	3000	1	5
3324	3000	1	5
3325	3000	1	5
3326	3000	1	5
3327	3000	1	5
3328	3000	1	5

Postcode	Terminal	Zone in	Zone out
3329	3000	1	5
3330	3000	1	5
3331	3000	1	5
3332	3000	1	5
3333	3000	1	5
3334	3000	1	5
3335	3000	1	5
3336	3000	1	5
3337	3000	1	5
3338	3000	1	5
3339	3000	1	5
3340	3000	1	4
3341	3000	1	4
3342	3000	1	4
3343	3000	1	4
3344	3000	1	4
3345	3000	1	4
3346	3000	1	4
3347	3000	1	4
3348	3000	1	4
3349	3000	1	4
3350	3000	1	5
3351	3000	1	5
3352	3000	1	5
3353	3000	1	5
3354	3000	1	5

Postcode	Terminal	Zone in	Zone out
3355	3000	1	5
3356	3000	1	5
3357	3000	1	5
3358	3000	1	5
3359	3000	1	5
3360	3000	1	5
3361	3000	1	5
3362	3000	1	5
3363	3000	1	5
3364	3000	1	5
3365	3000	1	5
3366	3000	1	5
3367	3000	1	5
3368	3000	1	5
3369	3000	1	5
3370	3000	1	4
3371	3000	1	4
3372	3000	1	4
3373	3000	1	4
3374	3000	1	4
3375	3000	1	4
3376	3000	1	4
3377	3000	1	4
3378	3000	1	4
3379	3000	1	4
3380	3000	1	4

Postcode	Terminal	Zone in	Zone out
3381	3000	1	4
3382	3000	1	4
3383	3000	1	4
3384	3000	1	4
3385	3000	1	4
3386	3000	1	4
3387	3000	1	4
3388	3000	1	4
3389	3000	1	4
3390	3000	1	4
3391	3000	1	4
3392	3000	1	4
3393	3000	1	4
3394	3000	1	4
3395	3000	1	4
3396	3000	1	4
3397	3000	1	4
3398	3000	1	4
3399	3000	1	4
3400	3000	0	3
3401	3000	0	3
3402	3000	0	3
3403	3000	0	3
3404	3000	0	4
3405	3000	0	4
3406	3000	1	4

Postcode	Terminal	Zone in	Zone out
3407	3000	1	4
3408	3000	1	4
3409	3000	1	4
3410	3000	1	4
3411	3000	1	4
3412	3000	0	3
3413	3000	0	3
3414	3000	0	3
3415	3000	0	3
3416	3000	0	3
3417	3000	0	3
3418	3000	0	3
3419	3000	0	3
3420	3000	0	3
3421	3000	0	3
3422	3000	0	3
3423	3000	0	3
3424	3000	0	3
3425	3000	0	4
3426	3000	1	4
3427	3000	1	4
3428	3000	1	4
3429	3000	1	4
3430	3000	1	4
3431	3000	1	4
3432	3000	1	4

Postcode	Terminal	Zone in	Zone out
3433	3000	1	4
3434	3000	1	4
3435	3000	1	4
3436	3000	1	4
3437	3000	1	4
3438	3000	1	4
3439	3000	1	4
3440	3000	1	4
3441	3000	1	4
3442	3000	1	5
3443	3000	1	5
3444	3000	1	5
3445	3000	1	5
3446	3000	1	5
3447	3000	1	5
3448	3000	1	5
3449	3000	1	5
3450	3000	1	4
3451	3000	1	4
3452	3000	1	4
3453	3000	1	4
3454	3000	1	4
3455	3000	1	4
3456	3000	1	4
3457	3000	1	4
3458	3000	1	4

Postcode	Terminal	Zone in	Zone out
3459	3000	1	4
3460	3000	1	4
3461	3000	1	4
3462	3000	1	4
3463	3000	1	4
3464	3000	1	4
3465	3000	1	4
3466	3000	1	4
3467	3000	1	4
3468	3000	1	4
3469	3000	1	4
3470	3000	1	4
3471	3000	1	4
3472	3000	1	5
3473	3000	1	5
3474	3000	1	4
3475	3000	1	4
3476	3000	1	4
3477	3000	1	4
3478	3000	1	4
3479	3000	1	4
3480	3000	1	4
3481	3000	1	4
3482	3000	1	4
3483	3000	1	4
3484	3000	1	5

Postcode	Terminal	Zone in	Zone out
3485	3000	1	5
3486	3000	1	5
3487	3000	1	5
3488	3000	1	5
3489	3000	1	5
3490	3000	1	4
3491	3000	1	4
3492	3000	1	4
3493	3000	1	4
3494	3000	1	4
3495	3000	1	4
3496	3000	1	4
3497	3000	1	4
3498	3000	1	4
3499	3000	1	4
3500	3000	1	4
3501	3000	1	4
3502	3000	1	4
3503	3000	1	4
3504	3000	1	4
3505	3000	1	4
3506	3000	1	4
3507	3000	1	4
3508	3000	1	4
3509	3000	1	4
3510	3000	1	4

Postcode	Terminal	Zone in	Zone out
3511	3000	1	4
3512	3000	1	5
3513	3000	1	4
3514	3000	1	4
3515	3000	1	4
3516	3000	1	4
3517	3000	1	4
3518	3000	1	4
3519	3000	1	5
3520	3000	1	4
3521	3000	1	4
3522	3000	1	5
3523	3000	1	5
3524	3000	1	5
3525	3000	1	5
3526	3000	1	4
3527	3000	1	4
3528	3000	1	5
3529	3000	1	4
3530	3000	1	4
3531	3000	1	4
3532	3000	1	4
3533	3000	1	4
3534	3000	1	5
3535	3000	1	5
3536	3550	1	5

Postcode	Terminal	Zone in	Zone out
3537	3000	1	5
3538	3000	1	4
3539	3550	1	5
3540	3550	1	4
3541	3550	1	4
3542	3550	1	4
3543	3550	1	4
3544	3550	1	5
3545	3550	1	4
3546	3550	1	4
3547	3550	1	4
3548	3550	1	4
3549	3550	1	4
3550	3550	0	4
3551	3550	0	3
3552	3550	0	3
3553	3550	0	3
3554	3550	0	3
3555	3550	0	3
3556	3550	0	3
3557	3550	0	3
3558	3550	0	3
3559	3550	0	3
3560	3550	1	4
3561	3550	1	4
3562	3550	1	4

Postcode	Terminal	Zone in	Zone out
3563	3550	1	4
3564	3550	1	4
3565	3550	1	4
3566	3550	1	4
3567	3550	1	4
3568	3550	1	4
3569	3550	1	4
3570	3550	1	4
3571	3550	1	4
3572	3550	1	4
3573	3550	1	4
3574	3550	1	4
3575	3550	1	4
3576	3550	1	5
3577	3550	1	5
3578	3550	1	4
3579	3550	1	5
3580	3550	1	4
3581	3550	1	4
3582	3550	1	4
3583	3550	1	4
3584	3550	1	4
3585	3550	1	4
3586	3550	1	4
3587	3550	1	4
3588	3550	1	5

Postcode	Terminal	Zone in	Zone out
3589	3550	1	4
3590	3550	1	4
3591	3550	1	4
3592	3550	1	4
3593	3550	1	5
3594	3550	1	4
3595	3550	1	5
3596	3550	1	5
3597	3550	1	5
3598	3550	1	5
3599	3550	1	5
3600	3000	1	4
3601	3000	1	4
3602	3000	1	4
3603	3000	1	4
3604	3000	1	4
3605	3000	1	4
3606	3000	1	4
3607	3000	1	4
3608	3000	1	4
3609	3000	1	4
3610	3000	1	4
3611	3000	1	4
3612	3000	1	4
3613	3000	1	3
3614	3000	1	5

Postcode	Terminal	Zone in	Zone out
3615	3000	1	4
3616	3000	1	4
3617	3000	1	3
3618	3000	1	5
3619	3000	1	4
3620	3000	1	5
3621	3000	1	5
3622	3000	1	5
3623	3000	1	5
3624	3000	1	5
3625	3000	1	5
3626	3000	1	5
3627	3000	1	5
3628	3000	1	5
3629	3000	1	5
3630	3000	1	5
3631	3000	1	5
3632	3000	1	5
3633	3000	1	5
3634	3000	1	5
3635	3000	1	5
3636	3000	1	5
3637	3000	1	5
3638	3000	1	5
3639	3000	1	5
3640	3000	1	4

Postcode	Terminal	Zone in	Zone out
3641	3000	1	4
3642	3000	1	4
3643	3000	1	4
3644	3000	1	4
3645	3000	1	4
3646	3000	1	4
3647	3000	1	4
3648	3000	1	5
3649	3000	1	4
3650	3000	1	5
3651	3000	1	5
3652	3000	1	5
3653	3000	1	5
3654	3000	1	5
3655	3000	1	5
3656	3000	1	5
3657	3000	1	5
3658	3000	1	5
3659	3000	1	5
3660	3000	1	5
3661	3000	1	5
3662	3000	1	5
3663	3000	1	5
3664	3000	1	5
3665	3000	1	5
3666	3000	1	5

Postcode	Terminal	Zone in	Zone out
3667	3000	1	5
3668	3000	1	5
3669	3000	1	5
3670	3000	1	4
3671	3000	1	4
3672	3000	1	4
3673	3000	1	4
3674	3000	1	4
3675	3000	1	4
3676	3000	1	4
3677	3000	1	5
3678	3000	1	4
3679	3000	1	4
3680	3000	1	5
3681	3000	1	3
3682	3000	1	4
3683	3000	1	5
3684	3000	1	4
3685	3000	1	4
3686	3000	1	4
3687	3000	1	4
3688	3000	1	4
3689	3000	1	4
3690	3000	1	5
3691	3000	1	5
3692	3000	1	5

Postcode	Terminal	Zone in	Zone out
3693	3000	1	5
3694	3000	1	5
3695	3000	1	5
3696	3000	1	5
3697	3000	1	5
3698	3000	1	5
3699	3000	1	5
3700	3200	1	4
3701	3200	1	4
3702	3200	1	4
3703	3200	1	4
3704	3200	1	4
3705	3200	1	4
3706	3200	1	4
3707	3200	1	4
3708	3200	1	4
3709	3200	1	4
3710	3200	1	4
3711	3200	1	4
3712	3200	1	4
3713	3200	1	4
3714	3200	1	4
3715	3200	1	3
3716	3200	1	4
3717	3200	1	3
3718	3200	1	4

Postcode	Terminal	Zone in	Zone out
3719	3200	1	4
3720	3200	1	4
3721	3200	1	5
3722	3200	1	3
3723	3200	1	4
3724	3200	1	4
3725	3200	1	4
3726	3200	1	4
3727	3200	1	4
3728	3200	1	4
3729	3200	1	5
3730	3200	1	4
3731	3200	1	4
3732	3200	1	3
3733	3200	1	4
3734	3200	1	3
3735	3200	1	3
3736	3200	1	4
3737	3200	1	4
3738	3200	1	4
3739	3200	1	4
3740	3200	1	4
3741	3200	1	4
3742	3200	1	4
3743	3200	1	4
3744	3200	1	4

Postcode	Terminal	Zone in	Zone out
3745	3200	1	4
3746	3200	1	4
3747	3200	1	4
3748	3200	1	5
3749	3200	1	5
3750	3200	1	5
3751	3200	1	5
3752	3200	1	5
3753	3200	1	5
3754	3200	1	5
3755	3200	1	5
3756	3200	1	5
3757	3200	1	5
3758	3200	1	5
3759	3200	1	5
3760	3200	1	5
3761	3200	1	5
3762	3200	1	5
3763	3200	1	5
3764	3200	1	5
3765	3200	1	5
3766	3200	1	5
3767	3200	1	5
3768	3200	1	5
3769	3200	1	5
3770	3200	1	5

Postcode	Terminal	Zone in	Zone out
3771	3200	1	5
3772	3200	1	5
3773	3200	1	5
3774	3200	1	5
3775	3200	1	5
3776	3200	1	5
3777	3200	1	5
3778	3200	1	5
3779	3200	1	5
3780	3200	1	5
3781	3200	1	5
3782	3200	1	5
3783	3200	1	5
3784	3200	1	5
3785	3200	1	4
3786	3200	1	4
3787	3200	1	4
3788	3200	1	5
3789	3200	1	5
3790	3200	1	5
3791	3200	1	5
3792	3200	1	4
3793	3200	1	5
3794	3200	1	5
3795	3200	1	5
3796	3200	1	4

Postcode	Terminal	Zone in	Zone out
3797	3200	1	4
3798	3200	1	4
3799	3200	1	4
3800	3200	1	4
3801	3200	1	4
3802	3200	1	4
3803	3200	1	5
3804	3200	1	4
3805	3200	1	5
3806	3200	1	4
3807	3200	1	4
3808	3200	1	4
3809	3200	1	4
3810	3200	1	5
3811	3200	1	4
3812	3200	1	5
3813	3200	1	4
3814	3200	1	4
3815	3200	1	4
3816	3200	1	4
3817	3200	1	4
3818	3200	1	4
3819	3200	1	4
3820	3200	1	5
3821	3200	1	5
3822	3200	1	5

Postcode	Terminal	Zone in	Zone out
3823	3200	1	4
3824	3200	1	4
3825	3200	1	5
3826	3200	1	4
3827	3200	1	4
3828	3200	1	4
3829	3200	1	4
3830	3200	1	4
3831	3200	1	4
3832	3200	1	4
3833	3200	1	4
3834	3200	1	5
3835	3200	1	5
3836	3200	1	5
3837	3200	1	5
3838	3200	1	5
3839	3200	1	5
3840	3200	1	5
3841	3200	1	5
3842	3200	1	5
3843	3200	1	5
3844	3200	1	5
3845	3200	1	5
3846	3200	1	5
3847	3200	1	5
3848	3200	1	5

Postcode	Terminal	Zone in	Zone out
3849	3200	1	5
3850	3200	1	5
3851	3200	1	5
3852	3200	1	5
3853	3200	1	5
3854	3200	1	5
3855	3200	1	5
3856	3200	1	5
3857	3200	1	5
3858	3200	1	5
3859	3200	1	5
3860	3200	1	5
3861	3200	1	5
3862	3200	1	5
3863	3200	1	5
3864	3200	1	5
3865	3200	1	5
3866	3200	1	5
3867	3200	1	5
3868	3200	1	5
3869	3200	1	5
3870	3200	1	5
3871	3200	1	5
3872	3200	1	5
3873	3200	1	5
3874	3200	1	5

Postcode	Terminal	Zone in	Zone out
3875	3200	1	5
3876	3200	1	5
3877	3200	1	5
3878	3200	1	5
3879	3200	1	5
3880	3200	1	5
3881	3200	1	5
3882	3200	1	5
3883	3200	1	5
3884	3200	1	5
3885	3200	1	5
3886	3200	1	5
3887	3200	1	5
3888	3200	1	5
3889	3200	1	5
3890	3200	1	5
3891	3200	1	5
3892	3200	1	5
3893	3200	1	5
3894	3200	1	5
3895	3200	1	5
3896	3200	1	5
3897	3200	1	5
3898	3200	1	5
3899	3200	1	5
3900	3200	1	4

Postcode	Terminal	Zone in	Zone out
3901	3200	1	4
3902	3200	1	4
3903	3200	1	4
3904	3200	1	4
3905	3200	1	4
3906	3200	1	4
3907	3200	1	4
3908	3200	1	4
3909	3200	1	4
3910	3200	1	4
3911	3200	1	4
3912	3200	1	3
3913	3200	1	4
3914	3200	1	4
3915	3200	1	4
3916	3200	1	3
3917	3200	1	4
3918	3200	1	4
3919	3200	1	3
3920	3200	1	4
3921	3200	1	4
3922	3200	1	3
3923	3200	1	4
3924	3200	1	4
3925	3200	1	4
3926	3200	1	4

Postcode	Terminal	Zone in	Zone out
3927	3200	1	4
3928	3200	1	4
3929	3200	1	4
3930	3200	1	4
3931	3200	1	4
3932	3200	1	4
3933	3200	1	4
3934	3200	1	4
3935	3200	1	4
3936	3200	1	4
3937	3200	1	4
3938	3200	1	4
3939	3200	1	4
3940	3200	1	4
3941	3200	1	4
3942	3200	1	4
3943	3200	1	4
3944	3200	1	4
3945	3200	1	4
3946	3200	1	4
3947	3200	1	4
3948	3200	1	4
3949	3200	1	4
3950	3200	1	4
3951	3200	1	4
3952	3200	1	4

Postcode	Terminal	Zone in	Zone out
3953	3200	1	4
3954	3200	1	4
3955	3200	1	4
3956	3200	1	4
3957	3200	1	4
3958	3200	1	4
3959	3200	1	4
3960	3200	1	4
3961	3200	1	4
3962	3200	1	4
3963	3200	1	4
3964	3200	1	4
3965	3200	1	4
3966	3200	1	4
3967	3200	1	5
3968	3200	1	4
3969	3200	1	4
3970	3200	1	4
3971	3200	1	4
3972	3200	1	4
3973	3200	1	4
3974	3200	1	4
3975	3200	1	4
3976	3200	1	4
3977	3200	1	4
3978	3200	1	4

Postcode	Terminal	Zone in	Zone out
3979	3200	1	4
3980	3200	1	4
3981	3200	1	4
3982	3200	1	4
3983	3200	1	4
3984	3200	1	4
3985	3200	1	4
3986	3200	1	4
3987	3200	1	4
3988	3200	1	4
3989	3200	1	4
3990	3200	1	4
3991	3200	1	4
3992	3200	1	4
3993	3200	1	4
3994	3200	1	4
3995	3200	1	4
3996	3200	1	4
3997	3200	1	4
3998	3200	1	4
3999	3200	1	4
4000	4033	0	3
4001	4033	0	3
4002	4033	0	3
4003	4033	0	3
4004	4033	0	3

Postcode	Terminal	Zone in	Zone out
4005	4033	0	1
4006	4033	0	1
4007	4033	0	1
4008	4033	0	1
4009	4033	0	1
4010	4033	0	1
4011	4033	0	1
4012	4033	0	1
4013	4033	0	1
4014	4033	0	1
4015	4033	0	1
4016	4033	0	1
4017	4033	0	1
4018	4033	0	1
4019	4033	0	1
4020	4033	0	1
4021	4033	0	1
4022	4033	0	1
4023	4033	0	1
4024	4033	0	1
4025	4033	0	1
4026	4033	0	1
4027	4033	0	1
4028	4033	0	1
4029	4033	0	1
4030	4033	0	3

Postcode	Terminal	Zone in	Zone out
4031	4033	0	1
4032	4033	0	1
4033	4033	0	1
4034	4033	0	1
4035	4033	0	3
4036	4033	0	3
4037	4033	0	3
4038	4033	0	3
4039	4033	0	3
4040	4033	0	3
4041	4033	0	1
4042	4033	0	1
4043	4033	0	1
4044	4033	0	1
4045	4033	0	1
4046	4033	0	1
4047	4033	0	2
4048	4033	0	1
4049	4033	0	1
4050	4033	0	1
4051	4033	0	1
4052	4033	0	1
4053	4033	0	4
4054	4033	0	4
4055	4033	0	2
4056	4033	0	1

Postcode	Terminal	Zone in	Zone out
4057	4033	0	1
4058	4033	0	2
4059	4033	0	3
4060	4033	0	3
4061	4033	0	3
4062	4033	0	3
4063	4033	0	3
4064	4033	0	3
4065	4033	0	3
4066	4033	0	3
4067	4033	0	3
4068	4033	0	3
4069	4033	0	3
4070	4033	1	2
4071	4033	1	4
4072	4033	1	2
4073	4033	1	2
4074	4033	1	4
4075	4033	1	5
4076	4033	1	5
4077	4033	0	1
4078	4033	0	3
4079	4033	0	3
4080	4033	1	5
4081	4033	0	3
4082	4033	0	3

Postcode	Terminal	Zone in	Zone out
4083	4033	0	1
4084	4033	0	3
4085	4033	0	1
4086	4033	0	3
4087	4033	0	3
4088	4033	0	3
4089	4033	0	3
4090	4033	0	3
4091	4033	0	3
4092	4033	0	3
4093	4033	0	3
4094	4033	0	3
4095	4033	0	3
4096	4033	1	4
4097	4033	0	3
4098	4033	0	3
4099	4033	0	3
4100	4033	1	5
4101	4033	1	5
4102	4033	1	5
4103	4033	1	5
4104	4033	1	5
4105	4033	1	5
4106	4033	1	5
4107	4033	1	5
4108	4033	1	5

Postcode	Terminal	Zone in	Zone out
4109	4033	1	5
4110	4033	1	5
4111	4033	1	5
4112	4033	1	5
4113	4033	1	5
4114	4033	1	5
4115	4033	1	5
4116	4033	1	5
4117	4033	1	5
4118	4033	1	5
4119	4033	1	5
4120	4033	1	5
4121	4033	1	5
4122	4033	1	5
4123	4033	1	5
4124	4033	1	5
4125	4033	1	5
4126	4033	1	5
4127	4033	1	5
4128	4033	1	5
4129	4033	1	5
4130	4033	1	5
4131	4033	1	5
4132	4033	1	5
4133	4033	1	5
4134	5500	1	5

Postcode	Terminal	Zone in	Zone out
4135	5500	1	5
4136	4033	1	5
4137	4033	1	5
4138	4033	1	5
4139	4033	1	5
4140	4033	1	5
4141	4033	1	5
4142	4033	1	5
4143	4033	1	5
4144	4033	1	5
4145	4033	1	5
4146	5500	1	5
4147	5500	1	5
4148	4033	1	5
4149	4033	1	5
4150	4033	1	5
4151	4033	1	5
4152	4033	1	5
4153	4033	1	5
4154	4033	1	5
4155	4033	1	5
4156	4033	1	5
4157	4033	1	5
4158	4033	1	5
4159	4033	1	5
4160	4033	1	5

Postcode	Terminal	Zone in	Zone out
4161	4033	1	5
4162	4033	1	5
4163	4033	1	5
4164	4033	1	5
4165	4033	1	5
4166	4033	1	5
4167	4033	1	5
4168	4033	1	5
4169	4033	1	5
4170	4033	1	5
4171	4033	1	5
4172	4033	1	5
4173	4033	1	5
4174	4033	1	5
4175	4033	1	5
4176	4033	1	5
4177	4033	1	5
4178	4033	1	5
4179	4033	1	5
4180	4033	1	5
4181	4033	1	5
4182	4033	1	5
4183	4033	1	5
4184	4033	1	5
4185	4033	1	5
4186	4033	1	5

Postcode	Terminal	Zone in	Zone out
4187	4033	1	5
4188	4033	1	5
4189	4033	1	5
4190	5500	1	5
4191	5500	1	5
4192	5500	1	5
4193	5500	1	5
4194	5500	1	5
4195	5500	1	5
4196	5500	1	5
4197	5500	1	5
4198	5500	1	5
4199	5500	1	5
4200	5500	1	5
4201	5500	1	5
4202	5500	1	5
4203	5500	1	5
4204	5500	1	5
4205	5500	1	5
4206	5500	1	5
4207	5500	1	5
4208	5500	1	5
4209	5500	1	5
4210	5500	1	5
4211	5500	1	5
4212	5500	1	5

Postcode	Terminal	Zone in	Zone out
4213	5500	1	5
4214	5500	1	5
4215	5500	1	5
4216	5500	1	5
4217	5500	1	5
4218	5500	1	5
4219	5500	1	5
4220	5500	1	5
4221	5500	1	5
4222	5500	1	5
4223	5500	1	5
4224	5500	1	5
4225	5500	1	5
4226	5500	1	5
4227	5500	1	5
4228	5500	1	5
4229	5500	1	5
4230	5500	1	5
4231	5500	1	5
4232	5500	1	5
4233	5500	1	5
4234	5500	1	5
4235	5500	1	5
4236	5500	1	5
4237	5500	1	5
4238	5500	1	5

Postcode	Terminal	Zone in	Zone out
4239	5500	1	5
4240	5500	1	5
4241	5500	1	5
4242	5500	1	5
4243	5500	1	5
4244	5500	1	5
4245	5500	1	5
4246	5500	1	5
4247	5500	1	5
4248	5500	1	5
4249	5500	1	5
4250	5500	1	4
4251	5500	1	4
4252	5500	1	4
4253	5500	1	4
4254	5500	1	4
4255	5500	1	4
4256	5500	1	4
4257	5500	1	4
4258	5500	1	4
4259	5500	1	4
4260	5500	1	4
4261	5500	1	4
4262	5500	1	4
4263	5500	1	4
4264	5500	1	4

Postcode	Terminal	Zone in	Zone out
4265	5500	1	4
4266	5500	1	4
4267	5500	1	4
4268	5500	1	4
4269	5500	1	4
4270	5500	1	4
4271	5500	1	4
4272	5500	1	4
4273	5500	1	4
4274	5500	1	4
4275	5500	1	4
4276	5500	1	4
4277	5500	1	4
4278	5500	1	4
4279	5500	1	4
4280	5500	1	5
4281	5500	1	5
4282	5500	1	5
4283	5500	1	5
4284	5500	1	5
4285	5500	1	5
4286	5500	1	5
4287	5500	1	5
4288	5500	1	5
4289	5500	1	5
4290	5500	1	4

Postcode	Terminal	Zone in	Zone out
4291	5500	1	4
4292	5500	1	4
4293	5500	1	4
4294	5500	1	4
4295	5500	1	4
4296	5500	1	4
4297	5500	1	5
4298	5500	1	4
4299	5500	1	4
4300	4033	0	3
4301	4033	0	3
4302	4033	0	3
4303	4033	0	3
4304	4033	0	3
4305	4033	0	3
4306	4033	0	1
4307	4033	0	1
4308	4033	0	4
4309	4033	0	4
4310	4033	1	4
4311	4033	1	4
4312	4033	0	4
4313	4033	0	1
4314	4033	0	1
4315	4033	0	1
4316	4033	0	1

Postcode	Terminal	Zone in	Zone out
4317	4033	0	1
4318	4033	0	1
4319	4033	0	1
4320	4033	0	1
4321	4033	0	1
4322	4033	0	1
4323	4033	0	1
4324	4033	0	1
4325	4033	0	1
4326	4033	0	1
4327	4033	0	1
4328	4033	0	1
4329	4033	0	2
4330	4033	1	4
4331	4033	1	4
4332	4033	1	4
4333	4033	1	5
4334	4033	1	5
4335	4033	1	5
4336	4033	0	4
4337	4033	0	4
4338	4033	0	4
4339	4033	1	4
4340	4033	0	3
4341	4033	0	4
4342	4033	1	5

Postcode	Terminal	Zone in	Zone out
4343	4033	1	5
4344	4033	0	3
4345	4033	0	3
4346	4033	0	4
4347	4033	1	4
4348	4033	1	4
4349	4033	0	3
4350	4033	1	4
4351	4033	1	4
4352	4033	1	4
4353	4033	1	4
4354	4033	1	4
4355	4033	1	4
4356	4033	1	4
4357	4033	1	4
4358	4033	1	4
4359	4033	1	4
4360	4033	1	4
4361	4033	1	4
4362	4033	1	4
4363	4033	1	5
4364	4033	1	5
4365	4033	1	4
4366	4033	1	4
4367	4033	1	4
4368	4033	1	4

Postcode	Terminal	Zone in	Zone out
4369	4033	1	4
4370	4033	1	4
4371	4033	1	4
4372	4033	1	4
4373	4033	1	4
4374	4033	1	4
4375	4033	1	5
4376	4033	1	5
4377	4033	1	5
4378	4033	1	4
4379	4033	1	4
4380	4033	1	5
4381	4033	1	5
4382	4033	1	5
4383	4033	1	5
4384	4033	1	5
4385	4033	1	5
4386	4033	1	5
4387	4033	1	5
4388	4033	1	5
4389	4033	1	5
4390	4033	1	5
4391	4033	0	3
4392	4033	0	3
4393	4033	1	5
4394	4033	0	3

Postcode	Terminal	Zone in	Zone out
4395	4033	1	4
4396	4033	0	3
4397	4033	0	3
4398	4033	1	5
4399	4033	0	3
4400	4033	1	4
4401	4033	1	4
4402	4033	1	4
4403	4033	1	4
4404	4033	1	4
4405	4033	1	4
4406	4033	1	4
4407	4033	1	4
4408	4033	1	4
4409	4033	1	4
4410	4033	1	4
4411	4033	1	4
4412	4033	1	4
4413	4033	1	4
4414	4033	1	4
4415	4033	1	4
4416	4033	1	4
4417	4033	1	4
4418	4033	1	4
4419	4033	1	4
4420	4033	1	5

Postcode	Terminal	Zone in	Zone out
4421	4033	1	5
4422	4033	1	5
4423	4033	1	5
4424	4033	1	5
4425	4033	1	5
4426	4033	1	5
4427	4033	1	5
4428	4033	1	5
4429	4033	1	5
4430	4033	1	4
4431	4033	1	4
4432	4033	1	5
4433	4033	1	4
4434	4033	1	5
4435	4033	1	5
4436	4033	1	5
4437	4033	1	5
4438	4033	1	5
4439	4033	1	5
4440	4033	1	5
4441	4033	1	5
4442	4033	1	5
4443	4033	1	5
4444	4033	1	5
4445	4033	1	5
4446	4033	1	5

Postcode	Terminal	Zone in	Zone out
4447	4033	1	5
4448	4033	1	5
4449	4033	1	5
4450	4033	1	5
4451	4033	1	5
4452	4033	1	5
4453	4033	1	5
4454	4033	1	5
4455	4033	1	5
4456	4033	1	5
4457	4033	1	5
4458	4033	1	5
4459	4033	1	5
4460	4033	1	4
4461	4033	1	4
4462	4033	1	5
4463	4033	1	5
4464	4033	1	5
4465	4033	1	4
4466	4033	1	4
4467	4033	1	4
4468	4033	1	4
4469	4033	1	4
4470	4033	1	5
4471	4033	1	5
4472	4033	1	5

Postcode	Terminal	Zone in	Zone out
4473	4033	1	5
4474	4033	1	5
4475	4033	1	5
4476	4033	1	5
4477	4033	1	5
4478	4033	1	5
4479	4033	1	5
4480	4033	1	5
4481	4033	1	5
4482	4033	1	5
4483	4033	1	5
4484	4033	1	5
4485	4033	1	5
4486	4033	1	5
4487	4033	1	5
4488	4033	1	5
4489	4033	1	5
4490	4033	1	5
4491	4033	1	5
4492	4033	1	5
4493	4033	1	5
4494	4033	1	5
4495	4033	1	5
4496	4033	1	5
4497	4033	1	5
4498	4033	1	5

Postcode	Terminal	Zone in	Zone out
4499	4033	1	5
4500	4600	1	4
4501	4600	1	4
4502	4600	1	4
4503	4600	1	4
4504	4600	1	4
4505	4600	1	4
4506	4600	1	4
4507	4600	1	4
4508	4600	1	4
4509	4600	1	4
4510	4600	1	4
4511	4600	1	4
4512	4600	1	4
4513	4600	1	4
4514	4600	1	4
4515	4600	1	4
4516	4600	1	4
4517	4600	1	4
4518	4600	1	4
4519	4600	1	5
4520	4600	1	5
4521	4600	1	5
4522	4600	1	5
4523	4600	1	5
4524	4600	1	5

Postcode	Terminal	Zone in	Zone out
4525	4600	1	5
4526	4600	1	5
4527	4600	1	5
4528	4600	1	5
4529	4600	1	5
4530	4600	1	5
4531	4600	1	5
4532	4600	1	5
4533	4600	1	5
4534	4600	1	5
4535	4600	1	4
4536	4600	1	5
4537	4600	1	5
4538	4600	1	5
4539	4600	1	5
4540	4600	1	5
4541	4600	1	5
4542	4600	1	5
4543	4600	1	5
4544	4600	1	5
4545	4600	1	5
4546	4600	1	5
4547	4600	1	5
4548	4600	1	5
4549	4600	1	5
4550	4600	1	5

Postcode	Terminal	Zone in	Zone out
4551	4600	1	5
4552	4600	1	5
4553	4600	1	5
4554	4600	1	5
4555	4600	1	5
4556	4600	1	5
4557	4600	1	5
4558	4600	1	5
4559	4600	1	5
4560	4600	1	5
4561	4600	1	5
4562	4600	1	5
4563	4600	1	5
4564	4600	1	5
4565	4600	1	5
4566	4600	1	5
4567	4600	1	5
4568	4600	1	5
4569	4600	1	5
4570	4600	1	4
4571	4600	1	4
4572	4600	1	4
4573	4600	1	4
4574	4600	1	4
4575	4600	1	4
4576	4600	1	4

Postcode	Terminal	Zone in	Zone out
4577	4600	1	4
4578	4600	1	4
4579	4600	1	4
4580	4600	1	4
4581	4600	1	4
4582	4600	1	4
4583	4600	1	4
4584	4600	1	4
4585	4600	1	5
4586	4600	1	5
4587	4600	1	5
4588	4600	1	5
4589	4600	1	5
4590	4600	1	5
4591	4600	1	5
4592	4600	1	5
4593	4600	1	5
4594	4600	1	5
4595	4600	1	5
4596	4600	1	5
4597	4600	1	5
4598	4600	1	5
4599	4600	1	5
4600	4600	0	3
4601	4600	0	3
4602	4600	0	3

Postcode	Terminal	Zone in	Zone out
4603	4600	0	3
4604	4600	0	3
4605	4600	0	3
4606	4600	0	3
4607	4600	0	3
4608	4600	0	3
4609	4600	0	3
4610	4600	0	3
4611	4600	0	3
4612	4600	0	3
4613	4600	0	3
4614	4600	0	3
4615	4600	0	4
4616	4600	0	3
4617	4600	0	4
4618	4600	0	4
4619	4600	0	4
4620	4600	0	3
4621	4600	0	3
4622	4600	0	3
4623	4600	0	3
4624	4600	0	3
4625	4600	1	4
4626	4600	0	3
4627	4600	0	3
4628	4600	0	3

Postcode	Terminal	Zone in	Zone out
4629	4600	0	3
4630	4600	0	3
4631	4600	0	3
4632	4600	0	3
4633	4600	0	3
4634	4600	0	4
4635	4600	0	3
4636	4600	0	3
4637	4600	0	3
4638	4600	0	3
4639	4600	0	4
4640	4600	1	4
4641	4600	1	4
4642	4600	1	4
4643	4600	1	4
4644	4600	1	5
4645	4600	1	4
4646	4600	1	5
4647	4600	1	4
4648	4600	1	4
4649	4600	1	4
4650	4600	1	4
4651	4600	1	4
4652	4600	1	4
4653	4600	1	4
4654	4600	1	4

Postcode	Terminal	Zone in	Zone out
4655	4600	0	3
4656	4600	0	4
4657	4600	0	4
4658	4600	1	4
4659	4600	1	4
4660	4600	1	4
4661	4600	0	3
4662	4600	0	3
4663	4600	0	3
4664	4600	0	3
4665	4600	0	3
4666	4600	0	3
4667	4600	0	3
4668	4600	0	3
4669	4600	0	3
4670	4600	0	3
4671	4600	0	3
4672	4600	0	3
4673	4600	0	3
4674	4600	0	3
4675	4600	0	3
4676	4600	0	3
4677	4600	0	3
4678	4600	0	3
4679	4600	1	4
4680	4600	1	5

Postcode	Terminal	Zone in	Zone out
4681	4600	1	5
4682	4600	1	4
4683	4600	1	4
4684	4600	0	3
4685	4600	1	4
4686	4600	0	3
4687	4600	0	3
4688	4600	0	3
4689	4600	0	3
4690	4600	0	3
4691	4600	0	3
4692	4600	0	3
4693	4600	0	3
4694	4600	1	5
4695	4600	0	3
4696	4600	0	3
4697	4600	0	3
4698	4600	0	3
4699	4600	1	4
4700	4600	0	3
4701	4600	0	3
4702	4600	0	3
4703	4600	0	3
4704	4600	0	3
4705	4600	1	4
4706	4600	0	4

Postcode	Terminal	Zone in	Zone out
4707	4600	0	4
4708	4600	0	3
4709	4600	0	3
4710	4600	0	3
4711	4600	0	3
4712	4600	0	3
4713	4600	0	3
4714	4600	0	3
4715	4600	1	4
4716	4600	1	4
4717	4600	1	4
4718	4600	1	4
4719	4600	1	4
4720	4600	1	5
4721	4600	1	4
4722	4600	1	4
4723	4600	1	5
4724	4600	1	5
4725	4600	1	5
4726	4600	1	5
4727	4600	1	5
4728	4600	1	5
4729	4600	1	5
4730	4600	1	5
4731	4600	1	5
4732	4600	1	5

Postcode	Terminal	Zone in	Zone out
4733	4600	1	4
4734	4600	1	4
4735	4600	1	4
4736	4600	1	4
4737	4600	1	5
4738	4600	1	4
4739	4600	1	4
4740	4600	1	4
4741	4600	1	5
4742	4600	1	5
4743	4600	1	5
4744	4600	1	5
4745	4600	1	5
4746	4600	1	5
4747	4600	1	5
4748	4600	1	5
4749	4600	1	5
4750	4600	1	5
4751	4600	1	5
4752	4600	1	5
4753	4600	1	5
4754	4600	1	5
4755	4600	1	5
4756	4600	1	5
4757	4600	1	5
4758	4600	1	5

Postcode	Terminal	Zone in	Zone out
4759	4600	1	5
4760	4600	1	5
4761	4600	1	4
4762	4600	1	4
4763	4600	1	4
4764	4600	1	4
4765	4600	1	4
4766	4600	1	5
4767	4600	1	5
4768	4600	1	5
4769	4600	1	5
4770	4600	1	4
4771	4600	1	4
4772	4600	1	4
4773	4600	1	4
4774	4600	1	4
4775	4600	1	4
4776	4600	1	4
4777	4600	1	4
4778	4600	1	4
4779	4600	1	4
4780	4600	1	4
4781	4600	1	4
4782	4600	1	4
4783	4600	1	4
4784	4600	1	4

Postcode	Terminal	Zone in	Zone out
4785	4600	1	4
4786	4600	1	4
4787	4600	1	4
4788	4600	1	4
4789	4600	1	4
4790	4600	1	4
4791	4600	1	4
4792	4600	1	4
4793	4600	1	4
4794	4600	1	4
4795	4600	1	4
4796	4600	1	4
4797	4600	1	4
4798	4600	1	4
4799	4600	1	4
4800	4600	1	4
4801	4600	1	4
4802	4600	1	4
4803	4600	1	4
4804	4600	1	4
4805	4600	1	4
4806	4600	1	4
4807	4600	1	4
4808	4600	1	4
4809	4600	1	4
4810	4600	1	4

Postcode	Terminal	Zone in	Zone out
4811	4600	1	4
4812	4600	1	4
4813	4600	1	4
4814	4600	1	4
4815	4600	1	4
4816	4600	1	4
4817	4600	1	4
4818	4600	1	4
4819	4600	1	4
4820	4600	1	4
4821	4600	1	4
4822	4600	1	4
4823	4600	1	4
4824	4600	1	4
4825	4600	1	4
4826	4600	1	4
4827	4600	1	5
4828	4600	1	5
4829	4600	1	5
4830	4600	1	5
4831	4600	1	5
4832	4600	1	5
4833	4600	1	5
4834	4600	1	5
4835	4600	1	5
4836	4600	1	3

Postcode	Terminal	Zone in	Zone out
4837	4600	1	4
4838	4600	1	3
4839	4600	1	4
4840	4600	1	4
4841	4600	1	4
4842	4600	1	4
4843	4600	1	4
4844	4600	1	4
4845	4600	1	4
4846	4600	1	4
4847	4600	1	4
4848	4600	1	4
4849	4600	1	4
4850	4600	1	4
4851	4600	1	4
4852	4600	1	4
4853	4600	1	4
4854	4600	1	4
4855	4600	1	4
4856	4600	1	4
4857	4600	1	4
4858	4600	1	4
4859	4600	1	4
4860	4600	1	4
4861	4600	1	4
4862	4600	1	4

Postcode	Terminal	Zone in	Zone out
4863	4600	1	5
4864	4600	1	5
4865	4600	1	5
4866	4600	1	5
4867	4600	1	5
4868	4600	1	5
4869	4600	1	5
4870	4600	1	4
4871	4600	1	4
4872	4600	1	4
4873	4600	1	4
4874	4600	1	4
4875	4600	1	4
4876	4600	1	3
4877	4600	1	4
4878	4600	1	4
4879	4600	1	4
4880	4600	1	4
4881	4600	1	4
4882	4600	1	4
4883	4600	1	4
4884	4600	1	4
4885	4600	1	4
4886	4600	1	4
4887	4600	1	4
4888	4600	1	4

Postcode	Terminal	Zone in	Zone out
4889	4600	1	4
4890	4600	1	4
4891	4600	1	4
4892	4600	1	4
4893	4600	1	4
4894	4600	1	4
4895	4600	1	4
4896	4600	1	4
4897	4600	1	4
4898	4600	1	4
4899	4600	1	4
4900	4600	1	4
4901	4600	1	4
4902	4600	1	4
4903	4600	1	4
4904	4600	1	4
4905	4600	1	4
4906	4600	1	4
4907	4600	1	4
4908	4600	1	4
4909	4600	1	5
4910	4600	1	5
4911	4600	1	5
4912	4600	1	5
4913	4600	1	5
4914	4600	1	5

Postcode	Terminal	Zone in	Zone out
4915	4600	1	5
4916	4600	1	5
4917	4600	1	5
4918	4600	1	5
4919	4600	1	5
4920	4600	1	5
4921	4600	1	5
4922	4600	1	5
4923	4600	1	5
4924	4600	1	5
4925	4600	1	5
4926	4600	1	5
4927	4600	1	5
4928	4600	1	5
4929	4600	1	5
4930	4600	1	5
4931	4600	1	5
4932	4600	1	5
4933	4600	1	5
4934	4600	1	5
4935	4600	1	5
4936	4600	1	5
4937	4600	1	5
4938	4600	1	5
4939	4600	1	5
4940	4600	1	4

Postcode	Terminal	Zone in	Zone out
4941	4600	1	4
4942	4600	1	4
4943	4600	1	4
4944	4600	1	4
4945	4600	1	4
4946	4600	1	4
4947	4600	1	4
4948	4600	1	4
4949	4600	1	4
4950	4600	1	4
4951	4600	1	4
4952	4600	1	4
4953	4600	1	4
4954	4600	1	4
4955	4600	1	4
4956	4600	1	4
4957	4600	1	4
4958	4600	1	4
4959	4600	1	4
4960	4600	1	4
4961	4600	1	4
4962	4600	1	4
4963	4600	1	4
4964	4600	1	4
4965	4600	1	4
4966	4600	1	4

Postcode	Terminal	Zone in	Zone out
4967	4600	1	4
4968	4600	1	4
4969	4600	1	4
4970	4600	1	5
4971	4600	1	5
4972	4600	1	5
4973	4600	1	5
4974	4600	1	5
4975	4600	1	5
4976	4600	1	5
4977	4600	1	5
4978	4600	1	5
4979	4600	1	5
4980	4600	1	5
4981	4600	1	5
4982	4600	1	5
4983	4600	1	5
4984	4600	1	5
4985	4600	1	5
4986	4600	1	5
4987	4600	1	5
4988	4600	1	5
4989	4600	1	5
4990	4600	1	5
4991	4600	1	5
4992	4600	1	5

Postcode	Terminal	Zone in	Zone out
4993	4600	1	5
4994	4600	1	4
4995	4600	1	4
4996	4600	1	4
4997	4600	1	4
4998	4600	1	4
4999	4600	1	4
5000	5000	0	3
5001	5000	0	3
5002	5000	0	3
5003	5000	0	1
5004	5000	0	1
5005	5000	0	1
5006	5000	0	1
5007	5000	0	1
5008	5000	0	1
5009	5000	0	1
5010	5000	0	1
5011	5000	0	1
5012	5000	0	1
5013	5000	0	1
5014	5000	0	1
5015	5000	0	1
5016	5000	0	1
5017	5000	0	2
5018	5000	0	1

Postcode	Terminal	Zone in	Zone out
5019	5000	0	1
5020	5000	0	3
5021	5000	0	3
5022	5000	0	1
5023	5000	0	3
5024	5000	0	3
5025	5000	0	3
5026	5000	0	3
5027	5000	0	3
5028	5000	0	3
5029	5000	0	3
5030	5000	0	3
5031	5000	0	1
5032	5000	0	1
5033	5000	0	1
5034	5000	0	1
5035	5000	0	1
5036	5000	0	1
5037	5000	0	1
5038	5000	0	1
5039	5000	0	1
5040	5000	0	3
5041	5000	0	1
5042	5000	0	1
5043	5000	0	1
5044	5000	0	3

Postcode	Terminal	Zone in	Zone out
5045	5000	0	1
5046	5000	0	3
5047	5000	0	3
5048	5000	0	3
5049	5000	0	3
5050	5000	0	3
5051	5000	0	3
5052	5000	0	1
5053	5000	0	1
5054	5000	0	1
5055	5000	0	1
5056	5000	0	1
5057	5000	0	1
5058	5000	0	1
5059	5000	0	1
5060	5000	0	3
5061	5000	0	3
5062	5000	0	3
5063	5000	0	1
5064	5000	0	3
5065	5000	0	3
5066	5000	0	3
5067	5000	0	1
5068	5000	0	1
5069	5000	0	3
5070	5000	0	3

Postcode	Terminal	Zone in	Zone out
5071	5000	0	3
5072	5000	0	1
5073	5000	0	1
5074	5000	0	3
5075	5000	0	1
5076	5000	0	3
5077	5000	0	3
5078	5000	0	3
5079	5000	0	3
5080	5000	0	3
5081	5000	0	1
5082	5000	0	1
5083	5000	0	3
5084	5000	0	3
5085	5000	0	3
5086	5000	0	3
5087	5000	0	3
5088	5000	0	3
5089	5000	0	1
5090	5000	0	3
5091	5000	0	3
5092	5000	0	3
5093	5000	0	1
5094	5000	0	1
5095	5000	0	3
5096	5000	0	1

Postcode	Terminal	Zone in	Zone out
5097	5000	0	1
5098	5000	0	1
5099	5000	0	1
5100	5000	0	3
5101	5000	0	1
5102	5000	0	3
5103	5000	0	3
5104	5000	0	1
5105	5000	0	1
5106	5000	0	1
5107	5000	0	3
5108	5000	0	4
5109	5000	0	3
5110	5000	1	5
5111	5000	1	5
5112	5000	0	3
5113	5000	0	1
5114	5000	0	1
5115	5000	0	1
5116	5000	0	1
5117	5000	0	1
5118	5000	0	1
5119	5000	0	1
5120	5000	0	3
5121	5000	0	1
5122	5000	0	1

Postcode	Terminal	Zone in	Zone out
5123	5000	0	3
5124	5000	0	1
5125	5000	0	3
5126	5000	0	3
5127	5000	0	3
5128	5000	0	3
5129	5000	0	3
5130	5000	0	1
5131	5000	0	1
5132	5000	0	1
5133	5000	0	3
5134	5000	0	1
5135	5000	0	2
5136	5000	0	3
5137	5000	0	4
5138	5000	0	3
5139	5000	0	3
5140	5000	0	3
5141	5000	0	1
5142	5000	0	1
5143	5000	0	1
5144	5000	0	1
5145	5000	0	1
5146	5000	0	1
5147	5000	0	1
5148	5000	0	1

Postcode	Terminal	Zone in	Zone out
5149	5000	0	3
5150	5000	0	3
5151	5000	0	1
5152	5000	0	2
5153	5000	0	1
5154	5000	0	1
5155	5000	0	1
5156	5000	0	3
5157	5000	0	3
5158	5000	0	3
5159	5000	0	3
5160	5000	0	1
5161	5000	0	1
5162	5000	0	1
5163	5000	0	1
5164	5000	0	1
5165	5000	0	1
5166	5000	0	3
5167	5000	0	3
5168	5000	0	3
5169	5000	0	3
5170	5000	0	1
5171	5000	0	1
5172	5000	0	1
5173	5000	0	1
5174	5000	0	1

Postcode	Terminal	Zone in	Zone out
5175	5000	0	3
5176	5000	0	1
5177	5000	1	5
5178	5000	0	1
5179	5000	0	1
5180	5000	0	3
5181	5000	0	3
5182	5000	0	3
5183	5000	0	1
5184	5000	0	1
5185	5000	0	3
5186	5000	0	3
5187	5000	0	3
5188	5000	0	3
5189	5000	0	3
5190	5000	0	3
5191	5000	0	3
5192	5000	0	3
5193	5000	0	3
5194	5000	0	3
5195	5000	0	3
5196	5000	0	3
5197	5000	0	3
5198	5000	0	3
5199	5000	0	3
5200	5000	1	3

Postcode	Terminal	Zone in	Zone out
5201	5000	1	4
5202	5000	1	4
5203	5000	1	4
5204	5000	1	4
5205	5000	1	4
5206	5000	1	4
5207	5000	1	4
5208	5000	1	4
5209	5000	1	4
5210	5000	1	4
5211	5000	1	4
5212	5000	1	4
5213	5000	1	5
5214	5000	1	5
5215	5000	1	5
5216	5000	1	5
5217	5000	1	5
5218	5000	1	5
5219	5000	1	5
5220	5000	0	3
5221	5000	0	1
5222	5000	0	1
5223	5000	0	1
5224	5000	0	1
5225	5000	0	1
5226	5000	0	4

Postcode	Terminal	Zone in	Zone out
5227	5000	0	1
5228	5000	0	1
5229	5000	1	4
5230	5000	0	1
5231	5000	0	1
5232	5000	0	1
5233	5000	0	3
5234	5000	0	3
5235	5000	0	1
5236	5000	0	1
5237	5000	0	1
5238	5000	0	1
5239	5000	0	1
5240	5000	0	3
5241	5000	0	3
5242	5000	0	3
5243	5000	0	4
5244	5000	0	4
5245	5000	0	3
5246	5000	0	3
5247	5000	0	3
5248	5000	0	3
5249	5000	0	3
5250	5000	0	3
5251	5000	0	1
5252	5000	0	1

Postcode	Terminal	Zone in	Zone out
5253	5000	0	1
5254	5000	0	1
5255	5000	0	3
5256	5000	0	3
5257	5000	0	1
5258	5000	0	1
5259	5000	1	4
5260	5000	0	3
5261	5000	0	3
5262	5000	1	4
5263	5000	1	5
5264	5000	1	5
5265	5000	1	4
5266	5000	1	4
5267	5000	1	4
5268	5000	0	4
5269	5000	0	3
5270	5000	0	3
5271	5000	0	3
5272	5000	0	3
5273	5000	0	3
5274	5000	0	3
5275	5000	0	3
5276	5000	0	3
5277	5000	0	3
5278	5000	0	3

Postcode	Terminal	Zone in	Zone out
5279	5000	0	3
5280	5000	1	5
5281	5000	1	5
5282	5000	1	5
5283	5000	1	5
5284	5000	1	5
5285	5000	1	5
5286	5000	1	5
5287	5000	1	5
5288	5000	1	5
5289	5000	1	5
5290	5000	1	5
5291	5000	1	5
5292	5000	1	5
5293	5000	1	5
5294	5000	1	5
5295	5000	1	5
5296	5000	1	5
5297	5000	1	5
5298	5000	1	5
5299	5000	1	5
5300	5000	1	4
5301	5000	1	4
5302	5000	1	4
5303	5000	1	4
5304	5000	1	4

Postcode	Terminal	Zone in	Zone out
5305	5000	1	4
5306	5000	1	4
5307	5000	1	4
5308	5000	1	4
5309	5000	1	4
5310	5000	1	4
5311	5000	1	4
5312	5000	1	4
5313	5000	1	4
5314	5000	1	4
5315	5000	1	5
5316	5000	1	5
5317	5000	1	4
5318	5000	1	4
5319	5000	1	4
5320	5000	1	4
5321	5000	1	4
5322	5000	1	4
5323	5000	1	4
5324	5000	1	4
5325	5000	1	4
5326	5000	1	4
5327	5000	1	4
5328	5000	1	4
5329	5000	1	4
5330	5000	1	4

Postcode	Terminal	Zone in	Zone out
5331	5000	1	5
5332	5000	1	5
5333	5000	1	5
5334	5000	1	5
5335	5000	1	5
5336	5000	1	5
5337	5000	1	5
5338	5000	1	5
5339	5000	1	5
5340	5000	1	4
5341	5000	1	4
5342	5000	1	4
5343	5000	1	4
5344	5000	1	4
5345	5000	1	4
5346	5000	1	4
5347	5000	1	4
5348	5000	1	4
5349	5000	1	4
5350	5000	1	4
5351	5000	1	4
5352	5000	1	4
5353	5000	1	4
5354	5000	1	4
5355	5000	1	4
5356	5000	1	4

Postcode	Terminal	Zone in	Zone out
5357	5000	1	4
5358	5000	1	4
5359	5000	1	4
5360	5000	1	4
5361	5000	1	4
5362	5000	1	4
5363	5000	1	4
5364	5000	1	4
5365	5000	1	5
5366	5000	1	5
5367	5000	1	5
5368	5000	1	5
5369	5000	1	5
5370	5000	1	5
5371	5000	1	5
5372	5000	1	5
5373	5000	1	5
5374	5000	1	5
5375	5000	1	5
5376	5000	1	5
5377	5000	1	5
5378	5000	1	5
5379	5000	1	5
5380	5000	1	5
5381	5000	1	5
5382	5000	1	5

Postcode	Terminal	Zone in	Zone out
5383	5000	1	5
5384	5000	1	5
5385	5000	1	5
5386	5000	1	5
5387	5000	1	5
5388	5000	1	5
5389	5000	1	5
5390	5000	1	5
5391	5000	1	5
5392	5000	1	5
5393	5000	1	5
5394	5000	1	5
5395	5000	1	5
5396	5000	1	5
5397	5000	1	5
5398	5000	1	5
5399	5000	1	5
5400	5500	1	4
5401	5500	1	4
5402	5500	1	4
5403	5500	1	4
5404	5500	1	4
5405	5500	1	4
5406	5500	1	4
5407	5500	1	4
5408	5500	1	4

Postcode	Terminal	Zone in	Zone out
5409	5500	1	4
5410	5500	1	4
5411	5500	1	4
5412	5500	1	4
5413	5500	1	5
5414	5500	1	4
5415	5500	1	4
5416	5500	1	4
5417	5500	1	4
5418	5500	1	5
5419	5500	1	5
5420	5500	1	4
5421	5500	1	4
5422	5500	1	5
5423	5500	1	5
5424	5500	1	5
5425	5500	1	5
5426	5500	1	5
5427	5500	1	5
5428	5500	1	5
5429	5500	1	5
5430	5500	1	5
5431	5500	1	5
5432	5500	1	5
5433	5500	1	5
5434	5500	1	5

Postcode	Terminal	Zone in	Zone out
5435	5500	1	5
5436	5500	1	5
5437	5500	1	5
5438	5500	1	5
5439	5500	1	5
5440	5500	1	5
5441	5500	1	5
5442	5500	1	5
5443	5500	1	5
5444	5500	1	5
5445	5500	1	5
5446	5500	1	5
5447	5500	1	5
5448	5500	1	5
5449	5500	1	5
5450	5500	1	5
5451	5500	1	5
5452	5500	1	5
5453	5500	1	5
5454	5500	1	5
5455	5500	1	5
5456	5500	1	5
5457	5500	1	5
5458	5500	1	5
5459	5500	1	5
5460	5500	1	5

Postcode	Terminal	Zone in	Zone out
5461	5500	1	5
5462	5500	1	5
5463	5500	1	5
5464	5500	1	5
5465	5500	1	5
5466	5500	1	5
5467	5500	1	5
5468	5500	1	5
5469	5500	1	5
5470	5500	1	5
5471	5500	1	5
5472	5500	1	5
5473	5500	1	5
5474	5500	1	5
5475	5500	1	5
5476	5500	1	5
5477	5500	1	5
5478	5500	1	5
5479	5500	1	5
5480	5500	1	5
5481	5500	1	5
5482	5500	1	5
5483	5500	1	5
5484	5500	1	5
5485	5500	1	5
5486	5500	1	5

Postcode	Terminal	Zone in	Zone out
5487	5500	1	5
5488	5500	1	5
5489	5500	1	5
5490	5500	1	4
5491	5500	1	4
5492	5500	1	4
5493	5500	1	4
5494	5500	1	4
5495	5500	1	4
5496	5500	1	4
5497	5500	1	4
5498	5500	1	5
5499	5500	1	5
5500	5500	0	3
5501	5500	0	3
5502	5500	0	3
5503	5500	0	3
5504	5500	0	3
5505	5500	0	3
5506	5500	0	3
5507	5500	0	3
5508	5500	0	3
5509	5500	0	3
5510	5500	0	3
5511	5500	0	3
5512	5500	0	3

Postcode	Terminal	Zone in	Zone out
5513	5500	0	3
5514	5500	0	4
5515	5500	0	3
5516	5500	0	3
5517	5500	0	3
5518	5500	0	4
5519	5500	0	3
5520	5500	0	3
5521	5500	0	3
5522	5500	0	3
5523	5500	0	3
5524	5500	0	3
5525	5500	0	3
5526	5500	0	3
5527	5500	0	3
5528	5500	0	3
5529	5500	0	3
5530	5500	0	3
5531	5500	0	3
5532	5500	0	3
5533	5500	0	3
5534	5500	0	3
5535	5500	0	3
5536	5500	0	3
5537	5500	0	3
5538	5500	0	3

Postcode	Terminal	Zone in	Zone out
5539	5500	0	3
5540	5500	1	4
5541	5500	1	4
5542	5500	0	3
5543	5500	0	3
5544	5500	0	3
5545	5500	0	3
5546	5500	1	4
5547	5500	1	5
5548	5500	1	5
5549	5500	1	5
5550	5500	1	4
5551	5500	1	4
5552	5500	1	4
5553	5500	0	3
5554	5500	1	4
5555	5500	1	4
5556	5500	1	4
5557	5500	1	4
5558	5500	1	4
5559	5500	1	4
5560	5500	1	5
5561	5500	1	5
5562	5500	1	4
5563	5500	1	4
5564	5500	1	4

Postcode	Terminal	Zone in	Zone out
5565	5500	1	4
5566	5500	1	5
5567	5500	1	5
5568	5500	1	5
5569	5500	1	4
5570	5500	1	4
5571	5500	1	4
5572	5500	1	4
5573	5500	1	4
5574	5500	1	4
5575	5500	1	4
5576	5500	1	4
5577	5500	1	4
5578	5500	1	5
5579	5500	1	4
5580	5500	1	5
5581	5500	1	5
5582	5500	1	5
5583	5500	1	5
5584	5500	1	5
5585	5500	1	5
5586	5500	1	5
5587	5500	1	5
5588	5500	1	5
5589	5500	1	5
5590	5500	1	5

Postcode	Terminal	Zone in	Zone out
5591	5500	1	5
5592	5500	1	5
5593	5500	1	5
5594	5500	1	5
5595	5500	1	4
5596	5500	1	5
5597	5500	1	5
5598	5500	1	5
5599	5500	1	5
5600	5000	1	5
5601	5000	1	5
5602	5000	1	5
5603	5000	1	5
5604	5000	1	5
5605	5000	1	5
5606	5000	1	5
5607	5000	1	5
5608	5000	1	5
5609	5000	1	5
5610	5000	1	5
5611	5000	1	5
5612	5000	1	5
5613	5000	1	5
5614	5000	1	5
5615	5000	1	5
5616	5000	1	5

Postcode	Terminal	Zone in	Zone out
5617	5000	1	5
5618	5000	1	5
5619	5000	1	5
5620	5000	1	5
5621	5000	1	5
5622	5000	1	5
5623	5000	1	5
5624	5000	1	5
5625	5000	1	5
5626	5500	1	5
5627	5500	1	5
5628	5500	1	5
5629	5500	1	5
5630	5000	1	5
5631	5000	1	5
5632	5000	1	5
5633	5000	1	5
5634	5000	1	5
5635	5000	1	5
5636	5000	1	5
5637	5000	1	5
5638	5000	1	5
5639	5000	1	5
5640	5000	1	5
5641	5000	1	5
5642	5000	1	5

Postcode	Terminal	Zone in	Zone out
5643	5000	1	5
5644	5000	1	5
5645	5000	1	5
5646	5000	1	5
5647	5000	1	5
5648	5000	1	5
5649	5000	1	5
5650	5000	1	5
5651	5000	1	5
5652	5000	1	5
5653	5000	1	5
5654	5000	1	5
5655	5000	1	5
5656	5000	1	5
5657	5000	1	5
5658	5000	1	5
5659	5000	1	5
5660	5000	1	5
5661	5000	1	5
5662	5000	1	5
5663	5000	1	5
5664	5000	1	5
5665	5000	1	5
5666	5000	1	5
5667	5000	1	5
5668	5000	1	5

Postcode	Terminal	Zone in	Zone out
5669	5000	1	5
5670	5000	1	5
5671	5000	1	5
5672	5000	1	5
5673	5000	1	5
5674	5000	1	5
5675	5000	1	5
5676	5000	1	5
5677	5000	1	5
5678	5000	1	5
5679	5000	1	5
5680	5000	1	5
5681	5000	1	5
5682	5000	1	5
5683	5000	1	5
5684	5000	1	5
5685	5000	1	5
5686	5000	1	5
5687	5000	1	5
5688	5000	1	5
5689	5000	1	5
5690	5000	1	5
5691	5000	1	5
5692	5000	1	5
5693	5000	1	5
5694	5000	1	5

Postcode	Terminal	Zone in	Zone out
5695	5000	1	5
5696	5000	1	5
5697	5000	1	5
5698	5000	1	5
5699	5000	1	5
5700	5000	1	5
5701	5000	1	5
5702	5000	1	5
5703	5000	1	5
5704	5000	1	5
5705	5000	1	4
5706	5000	1	5
5707	5000	1	5
5708	5000	1	5
5709	5000	1	5
5710	5000	1	5
5711	5000	1	5
5712	5000	1	5
5713	5000	1	5
5714	5000	1	5
5715	5000	1	5
5716	5000	1	5
5717	5000	1	5
5718	5000	1	5
5719	5000	1	5
5720	5000	1	5

Postcode	Terminal	Zone in	Zone out
5721	5000	1	5
5722	5000	1	5
5723	5000	1	5
5724	5000	1	5
5725	5000	1	4
5726	5000	1	4
5727	5000	1	5
5728	5000	1	5
5729	5000	1	5
5730	5000	1	5
5731	5000	1	5
5732	5000	1	5
5733	5000	1	5
5734	5000	1	5
5735	5000	1	5
5736	5000	1	5
5737	5000	1	5
5738	5000	1	5
5739	5000	1	5
5740	5000	1	5
5741	5000	1	5
5742	5000	1	5
5743	5000	1	5
5744	6800	1	5
5745	5000	1	5
5746	5000	1	5

Postcode	Terminal	Zone in	Zone out
5747	5000	1	5
5748	5000	1	5
5749	5000	1	5
5750	5000	1	5
5751	5000	1	5
5752	5000	1	5
5753	5000	1	5
5754	5000	1	5
5755	5500	1	5
5756	5500	1	5
5757	5500	1	5
5758	5500	1	5
5759	5500	1	5
5760	5500	1	5
5761	5500	1	5
5762	5500	1	5
5763	5500	1	5
5764	5500	1	5
5765	5500	1	5
5766	5500	1	5
5767	5500	1	5
5768	5500	1	5
5769	5500	1	5
5770	5500	1	5
5771	5500	1	5
5772	5500	1	5

Postcode	Terminal	Zone in	Zone out
5773	5500	1	5
5774	5500	1	5
5775	5500	1	5
5776	5500	1	5
5777	5500	1	5
5778	5500	1	5
5779	5500	1	5
5780	5500	1	5
5781	5500	1	5
5782	5500	1	5
5783	5500	1	5
5784	5500	1	5
5785	5500	1	5
5786	5500	1	5
5787	5500	1	5
5788	5500	1	5
5789	5500	1	5
5790	5500	1	5
5791	5500	1	5
5792	5500	1	5
5793	5500	1	5
5794	5500	1	5
5795	5500	1	5
5796	5500	1	5
5797	5500	1	5
5798	5500	1	5

Postcode	Terminal	Zone in	Zone out
5799	5500	1	5
5800	5000	1	5
5801	5000	0	3
5802	5000	0	3
5803	5000	0	3
5804	5000	0	3
5805	5000	0	3
5806	5000	0	3
5807	5000	0	3
5808	5000	0	3
5809	5000	0	3
5810	5000	1	4
5811	5000	0	3
5812	5000	0	3
5813	5000	0	3
5814	5000	0	3
5815	5000	0	3
5816	5000	0	3
5817	5000	0	3
5818	5000	0	3
5819	5000	0	3
5820	5000	0	3
5821	5000	0	3
5822	5000	0	3
5823	5000	0	3
5824	5000	0	3

Postcode	Terminal	Zone in	Zone out
5825	5000	0	3
5826	5000	0	3
5827	5000	1	4
5828	5000	0	3
5829	5000	0	3
5830	5000	0	3
5831	5000	0	3
5832	5000	1	4
5833	5000	1	4
5834	5000	1	4
5835	5000	0	3
5836	5000	0	3
5837	5000	0	3
5838	5000	0	3
5839	5000	0	3
5840	5000	0	3
5841	5000	0	3
5842	5000	0	3
5843	5000	1	4
5844	5000	1	4
5845	5000	0	3
5846	5000	0	3
5847	5000	0	3
5848	5000	0	3
5849	5000	0	3
5850	5000	1	4

Postcode	Terminal	Zone in	Zone out
5851	5000	0	3
5852	5000	0	3
5853	5000	0	3
5854	5000	0	3
5855	5000	1	5
5856	5000	0	3
5857	5000	0	3
5858	5000	0	3
5859	5000	0	3
5860	5000	1	4
5861	5000	0	3
5862	5000	0	3
5863	5000	0	3
5864	5000	0	3
5865	5000	1	4
5866	5000	1	4
5867	5000	1	4
5868	5000	0	3
5869	5000	0	3
5870	5000	1	4
5871	5000	0	3
5872	5000	0	3
5873	5000	0	3
5874	5000	0	3
5875	5000	1	4
5876	5000	0	3

Postcode	Terminal	Zone in	Zone out
5877	5000	0	3
5878	5000	0	3
5879	5000	0	3
5880	5000	0	3
5881	5000	0	3
5882	5000	0	3
5883	5000	0	3
5884	5000	0	3
5885	5000	1	5
5886	5000	0	3
5887	5000	0	3
5888	5000	0	3
5889	5000	0	3
5890	5000	0	3
5891	5000	0	3
5892	5000	0	3
5893	5000	0	3
5894	5000	0	3
5895	5000	0	3
5896	5000	0	3
5897	5000	1	5
5898	5000	1	5
5899	5000	0	3
5900	5000	1	5
5901	5000	1	5
5902	5000	1	4

Postcode	Terminal	Zone in	Zone out
5903	5000	1	4
5904	5000	1	4
5905	5000	1	4
5906	5000	1	4
5907	5000	1	5
5908	5000	1	4
5909	5000	1	4
5910	5000	1	5
5911	5000	1	5
5912	5000	1	5
5913	5000	1	5
5914	5000	1	4
5915	5000	1	5
5916	5000	1	4
5917	5000	1	5
5918	5000	1	4
5919	5000	1	4
5920	5000	1	4
5921	5000	1	4
5922	5000	1	4
5923	5000	1	4
5924	5000	1	4
5925	5000	1	5
5926	5000	1	5
5927	5000	1	5
5928	5000	1	5

Postcode	Terminal	Zone in	Zone out
5929	5000	1	5
5930	5000	1	4
5931	5000	1	5
5932	5000	1	5
5933	5000	1	5
5934	5000	1	5
5935	5000	1	4
5936	5000	1	5
5937	5000	1	5
5938	5000	1	5
5939	5000	1	5
5940	5000	1	4
5941	5000	1	5
5942	5000	1	4
5943	5000	1	5
5944	5000	1	4
5945	5000	1	4
5946	5000	1	5
5947	5000	1	5
5948	5000	1	5
5949	5000	1	5
5950	5000	1	5
5951	5000	1	5
5952	5000	1	4
5953	5000	1	5
5954	5000	1	5

Postcode	Terminal	Zone in	Zone out
5955	5000	1	5
5956	5000	1	5
5957	5000	1	5
5958	5000	1	5
5959	5000	1	5
5960	5000	1	5
5961	5000	1	5
5962	5000	1	5
5963	5000	1	5
5964	5000	1	5
5965	5000	1	5
5966	5000	1	5
5967	5000	1	5
5968	5000	1	5
5969	5000	1	5
5970	5000	1	5
5971	5000	1	5
5972	5000	1	5
5973	5000	1	5
5974	5000	1	5
5975	5000	1	5
5976	5000	1	5
5977	5000	1	5
5978	5000	1	5
5979	5000	1	5
5980	5000	1	5

Postcode	Terminal	Zone in	Zone out
5981	5000	1	5
5982	5000	1	5
5983	5000	1	5
5984	5000	1	5
5985	5000	1	5
5986	5000	1	5
5987	5000	1	5
5988	5000	1	5
5989	5000	1	5
5990	5000	1	5
5991	5000	1	5
5992	5000	1	5
5993	5000	1	5
5994	5000	1	5
5995	5000	1	5
5996	5000	1	5
5997	5000	1	5
5998	5000	1	5
5999	5000	1	5
6000	6000	0	3
6001	6000	0	3
6002	6000	0	3
6003	6000	0	3
6004	6000	0	3
6005	6000	0	3
6006	6000	0	3

Postcode	Terminal	Zone in	Zone out
6007	6000	0	3
6008	6000	0	3
6009	6000	0	3
6010	6000	0	4
6011	6000	0	4
6012	6000	0	3
6013	6000	0	4
6014	6000	0	3
6015	6000	0	3
6016	6000	0	3
6017	6000	0	3
6018	6000	0	3
6019	6000	0	3
6020	6000	0	3
6021	6000	0	3
6022	6000	0	3
6023	6000	0	3
6024	6000	0	3
6025	6000	0	3
6026	6000	0	3
6027	6000	0	3
6028	6000	0	3
6029	6000	0	3
6030	6000	1	4
6031	6000	1	4
6032	6000	1	4

Postcode	Terminal	Zone in	Zone out
6033	6000	1	4
6034	6000	1	4
6035	6000	1	4
6036	6000	1	4
6037	6000	0	3
6038	6000	1	4
6039	6000	1	4
6040	6000	1	4
6041	6000	1	4
6042	6000	1	4
6043	6000	0	3
6044	6000	0	3
6045	6000	0	3
6046	6000	0	3
6047	6000	0	3
6048	6000	0	3
6049	6000	0	3
6050	6000	1	4
6051	6000	1	4
6052	6000	1	4
6053	6000	1	4
6054	6000	1	5
6055	6000	1	5
6056	6000	1	4
6057	6000	1	4
6058	6000	1	4

Postcode	Terminal	Zone in	Zone out
6059	6000	1	4
6060	6000	1	4
6061	6000	1	4
6062	6000	1	4
6063	6000	1	4
6064	6000	1	4
6065	6000	1	4
6066	6000	1	4
6067	6000	1	4
6068	6000	1	4
6069	6000	1	4
6070	6000	1	4
6071	6000	1	4
6072	6000	1	4
6073	6000	1	4
6074	6000	1	4
6075	6000	1	4
6076	6000	1	4
6077	6000	1	5
6078	6000	1	5
6079	6000	1	4
6080	6000	1	4
6081	6000	1	4
6082	6000	1	4
6083	6000	1	5
6084	6000	1	5

Postcode	Terminal	Zone in	Zone out
6085	6000	1	5
6086	6000	1	5
6087	6000	1	5
6088	6000	1	5
6089	6000	1	5
6090	6000	1	4
6091	6000	1	4
6092	6000	1	4
6093	6000	1	5
6094	6000	1	5
6095	6000	1	4
6096	6000	1	5
6097	6000	1	5
6098	6000	1	5
6099	6000	1	4
6100	6000	1	4
6101	6000	1	4
6102	6000	1	4
6103	6000	1	4
6104	6000	1	4
6105	6000	1	4
6106	6000	1	5
6107	6000	1	4
6108	6000	1	4
6109	6000	1	4
6110	6000	1	5

Postcode	Terminal	Zone in	Zone out
6111	6000	1	5
6112	6000	1	5
6113	6000	1	5
6114	6000	1	5
6115	6000	1	5
6116	6000	1	5
6117	6000	1	5
6118	6000	1	5
6119	6000	1	5
6120	6000	1	5
6121	6000	1	5
6122	6000	1	5
6123	6000	1	5
6124	6000	1	5
6125	6000	1	5
6126	6000	1	5
6127	6000	1	5
6128	6000	1	5
6129	6000	1	5
6130	6000	1	5
6131	6000	1	5
6132	6000	1	5
6133	6000	1	5
6134	6000	1	5
6135	6000	1	5
6136	6000	1	5

Postcode	Terminal	Zone in	Zone out
6137	6000	1	5
6138	6000	1	5
6139	6000	1	5
6140	6000	1	5
6141	6000	1	5
6142	6000	1	5
6143	6000	1	5
6144	6000	1	5
6145	6000	1	5
6146	6000	1	5
6147	6000	1	5
6148	6000	1	5
6149	6000	1	5
6150	6000	1	4
6151	6000	1	4
6152	6000	1	4
6153	6000	1	4
6154	6000	1	4
6155	6000	1	4
6156	6000	1	5
6157	6000	1	4
6158	6000	1	4
6159	6000	1	4
6160	6000	1	4
6161	6000	1	4
6162	6000	1	4

Postcode	Terminal	Zone in	Zone out
6163	6000	1	5
6164	6000	1	5
6165	6000	1	5
6166	6000	1	5
6167	6000	1	5
6168	6000	1	5
6169	6000	1	5
6170	6000	1	5
6171	6000	1	4
6172	6000	1	4
6173	6000	1	4
6174	6000	1	5
6175	6000	1	4
6176	6000	1	4
6177	6000	1	4
6178	6000	1	4
6179	6000	1	4
6180	6000	1	5
6181	6000	1	5
6182	6000	1	5
6183	6000	1	5
6184	6000	1	5
6185	6000	1	5
6186	6000	1	5
6187	6000	1	5
6188	6000	1	5

Postcode	Terminal	Zone in	Zone out
6189	6000	1	5
6190	6000	1	5
6191	6000	1	5
6192	6000	1	5
6193	6000	1	5
6194	6000	1	5
6195	6000	1	5
6196	6000	1	5
6197	6000	1	5
6198	6000	1	5
6199	6000	1	5
6200	6000	1	4
6201	6000	1	4
6202	6000	1	4
6203	6000	1	4
6204	6000	1	4
6205	6000	1	4
6206	6000	1	4
6207	6000	1	4
6208	6000	1	4
6209	6000	1	4
6210	6000	1	5
6211	6000	1	5
6212	6000	1	5
6213	6000	1	5
6214	6000	1	5

Postcode	Terminal	Zone in	Zone out
6215	6000	1	5
6216	6000	1	5
6217	6000	1	5
6218	6000	1	5
6219	6000	1	5
6220	6000	1	5
6221	6000	1	4
6222	6000	1	4
6223	6000	1	4
6224	6000	1	5
6225	6000	1	5
6226	6000	1	5
6227	6000	1	5
6228	6000	1	5
6229	6000	1	5
6230	6000	1	4
6231	6000	1	4
6232	6000	1	4
6233	6000	1	4
6234	6000	1	4
6235	6000	1	4
6236	6000	1	4
6237	6000	1	4
6238	6000	1	4
6239	6000	1	4
6240	6000	1	4

Postcode	Terminal	Zone in	Zone out
6241	6000	1	4
6242	6000	1	4
6243	6000	1	4
6244	6000	1	4
6245	6000	1	4
6246	6000	1	4
6247	6000	1	4
6248	6000	1	4
6249	6000	1	4
6250	6000	1	5
6251	6000	1	4
6252	6000	1	5
6253	6000	1	5
6254	6000	1	5
6255	6000	1	5
6256	6000	1	5
6257	6000	1	4
6258	6000	1	4
6259	6000	1	4
6260	6000	0	4
6261	6000	0	3
6262	6000	0	3
6263	6000	0	3
6264	6000	1	4
6265	6000	1	4
6266	6000	1	4

Postcode	Terminal	Zone in	Zone out
6267	6000	1	4
6268	6000	1	4
6269	6000	1	4
6270	6000	1	4
6271	6000	1	4
6272	6000	1	4
6273	6000	1	4
6274	6000	1	4
6275	6000	1	4
6276	6000	1	4
6277	6000	1	4
6278	6000	1	4
6279	6000	1	4
6280	6000	1	4
6281	6000	1	4
6282	6000	1	4
6283	6000	1	4
6284	6000	1	5
6285	6000	1	5
6286	6000	1	5
6287	6000	1	5
6288	6000	1	5
6289	6000	1	5
6290	6000	1	5
6291	6000	1	5
6292	6000	1	5

Postcode	Terminal	Zone in	Zone out
6293	6000	1	5
6294	6000	1	5
6295	6000	1	5
6296	6000	1	5
6297	6000	1	5
6298	6000	1	5
6299	6000	1	5
6300	6401	1	4
6301	6401	1	4
6302	6401	1	4
6303	6401	1	4
6304	6401	1	4
6305	6401	1	4
6306	6401	1	4
6307	6401	1	4
6308	6401	1	4
6309	6401	1	4
6310	6401	1	4
6311	6401	1	4
6312	6401	1	4
6313	6401	1	4
6314	6401	1	4
6315	6401	1	5
6316	6401	1	4
6317	6401	1	4
6318	6401	1	4

Postcode	Terminal	Zone in	Zone out
6319	6401	1	4
6320	6401	1	5
6321	6401	1	4
6322	6401	1	4
6323	6401	1	4
6324	6401	1	4
6325	6401	1	4
6326	6401	1	4
6327	6401	1	4
6328	6401	1	4
6329	6401	1	4
6330	6401	1	5
6331	6401	1	5
6332	6401	1	5
6333	6401	1	5
6334	6401	1	5
6335	6401	1	5
6336	6401	1	5
6337	6401	1	4
6338	6401	1	4
6339	6401	1	4
6340	6401	1	4
6341	6401	1	4
6342	6401	1	4
6343	6401	1	4
6344	6401	1	4

Postcode	Terminal	Zone in	Zone out
6345	6401	1	4
6346	6401	1	4
6347	6401	1	4
6348	6401	1	4
6349	6401	1	4
6350	6401	1	5
6351	6401	1	5
6352	6401	1	5
6353	6401	1	5
6354	6401	1	5
6355	6401	1	5
6356	6401	1	5
6357	6401	1	5
6358	6401	1	5
6359	6401	1	5
6360	6401	1	5
6361	6401	1	4
6362	6401	1	4
6363	6401	1	5
6364	6401	1	5
6365	6401	1	5
6366	6401	1	5
6367	6401	1	5
6368	6401	1	5
6369	6401	1	5
6370	6401	1	4

Postcode	Terminal	Zone in	Zone out
6371	6401	1	4
6372	6401	1	4
6373	6401	1	4
6374	6401	1	4
6375	6401	1	4
6376	6401	1	4
6377	6401	1	4
6378	6401	1	4
6379	6401	1	4
6380	6401	1	4
6381	6401	1	4
6382	6401	1	4
6383	6401	1	4
6384	6401	1	4
6385	6401	1	4
6386	6401	1	4
6387	6401	1	5
6388	6401	1	4
6389	6401	1	4
6390	6401	1	4
6391	6401	1	5
6392	6401	1	5
6393	6401	1	4
6394	6401	1	5
6395	6401	1	5
6396	6401	1	4

Postcode	Terminal	Zone in	Zone out
6397	6401	1	4
6398	6401	1	4
6399	6401	1	4
6400	6401	0	3
6401	6401	0	3
6402	6401	0	3
6403	6401	0	3
6404	6401	0	3
6405	6401	0	3
6406	6401	0	3
6407	6401	0	3
6408	6401	1	5
6409	6401	0	4
6410	6401	0	3
6411	6401	0	4
6412	6401	0	3
6413	6401	0	3
6414	6401	0	4
6415	6401	0	3
6416	6401	0	3
6417	6401	1	4
6418	6401	1	5
6419	6401	0	3
6420	6401	1	5
6421	6401	0	4
6422	6401	0	4

Postcode	Terminal	Zone in	Zone out
6423	6401	0	3
6424	6401	0	3
6425	6401	0	3
6426	6401	1	5
6427	6401	1	5
6428	6401	1	5
6429	6401	0	4
6430	6401	1	4
6431	6401	1	4
6432	6401	1	4
6433	6401	1	5
6434	6401	0	3
6435	6401	0	3
6436	6401	0	3
6437	6401	0	3
6438	6401	0	3
6439	6401	0	3
6440	6401	1	4
6441	6401	1	4
6442	6401	1	4
6443	6401	1	4
6444	6401	1	4
6445	6401	1	4
6446	6401	1	4
6447	6401	1	4
6448	6401	1	4

Postcode	Terminal	Zone in	Zone out
6449	6401	1	4
6450	6401	1	4
6451	6401	1	4
6452	6401	1	4
6453	6401	1	5
6454	6401	1	4
6455	6401	1	5
6456	6401	1	4
6457	6401	1	4
6458	6401	1	4
6459	6401	1	4
6460	6401	1	5
6461	6401	1	4
6462	6401	1	5
6463	6401	1	5
6464	6401	1	5
6465	6401	1	5
6466	6401	1	5
6467	6401	1	5
6468	6401	1	5
6469	6401	1	5
6470	6401	1	5
6471	6401	1	5
6472	6401	1	5
6473	6401	1	5
6474	6401	1	5

Postcode	Terminal	Zone in	Zone out
6475	6401	1	5
6476	6401	1	5
6477	6401	1	5
6478	6401	1	5
6479	6401	1	5
6480	6401	1	5
6481	6401	1	5
6482	6401	1	5
6483	6401	1	5
6484	6401	1	5
6485	6401	1	5
6486	6401	1	5
6487	6401	1	5
6488	6401	1	5
6489	6401	1	5
6490	6401	1	4
6491	6401	1	4
6492	6401	1	4
6493	6401	1	4
6494	6401	1	4
6495	6401	1	4
6496	6401	1	4
6497	6401	1	4
6498	6401	1	4
6499	6401	1	4
6500	6401	0	3

Postcode	Terminal	Zone in	Zone out
6501	6401	0	3
6502	6401	0	3
6503	6401	0	3
6504	6401	0	3
6505	6401	0	3
6506	6401	0	3
6507	6401	0	3
6508	6401	0	3
6509	6401	0	4
6510	6401	0	3
6511	6401	0	3
6512	6401	0	3
6513	6401	0	3
6514	6401	0	3
6515	6401	0	3
6516	6401	0	3
6517	6401	0	3
6518	6401	0	3
6519	6401	0	3
6520	6401	1	4
6521	6401	1	4
6522	6401	1	4
6523	6401	1	4
6524	6401	1	4
6525	6401	1	4
6526	6401	1	4

Postcode	Terminal	Zone in	Zone out
6527	6401	1	4
6528	6401	1	4
6529	6401	1	4
6530	6401	1	4
6531	6401	1	4
6532	6401	1	4
6533	6401	1	4
6534	6401	1	4
6535	6401	1	4
6536	6401	1	4
6537	6401	1	4
6538	6401	1	4
6539	6401	1	4
6540	6401	1	4
6541	6401	1	4
6542	6401	1	4
6543	6401	1	4
6544	6401	1	4
6545	6401	1	4
6546	6401	1	4
6547	6401	1	4
6548	6401	1	4
6549	6401	1	4
6550	6401	1	4
6551	6401	1	4
6552	6401	1	4

Postcode	Terminal	Zone in	Zone out
6553	6401	1	4
6554	6401	1	4
6555	6401	1	4
6556	6401	1	4
6557	6401	1	4
6558	6401	1	4
6559	6401	1	4
6560	6401	1	5
6561	6401	1	5
6562	6401	1	5
6563	6401	1	5
6564	6401	1	5
6565	6401	1	5
6566	6401	1	5
6567	6401	1	5
6568	6401	1	5
6569	6401	1	5
6570	6401	1	5
6571	6401	1	5
6572	6401	1	5
6573	6401	1	5
6574	6401	1	5
6575	6401	1	5
6576	6401	1	5
6577	6401	1	5
6578	6401	1	5

Postcode	Terminal	Zone in	Zone out
6579	6401	1	5
6580	6401	1	5
6581	6401	1	5
6582	6401	1	5
6583	6401	1	5
6584	6401	1	5
6585	6401	1	5
6586	6401	1	5
6587	6401	1	5
6588	6401	1	5
6589	6401	1	5
6590	6401	1	5
6591	6401	1	5
6592	6401	1	5
6593	6401	1	5
6594	6401	1	5
6595	6401	1	5
6596	6401	1	5
6597	6401	1	5
6598	6401	1	5
6599	6401	1	5
6600	6401	1	4
6601	6401	1	4
6602	6401	1	4
6603	6401	1	4
6604	6401	1	4

Postcode	Terminal	Zone in	Zone out
6605	6401	1	4
6606	6401	1	4
6607	6401	1	4
6608	6401	1	4
6609	6401	1	4
6610	6401	1	5
6611	6401	1	4
6612	6401	1	5
6613	6401	1	5
6614	6401	1	5
6615	6401	1	5
6616	6401	1	5
6617	6401	1	5
6618	6401	1	5
6619	6401	1	5
6620	6401	1	5
6621	6401	1	5
6622	6401	1	5
6623	6401	1	5
6624	6401	1	5
6625	6401	1	5
6626	6401	1	5
6627	6401	1	5
6628	6401	1	5
6629	6401	1	5
6630	6401	1	5

Postcode	Terminal	Zone in	Zone out
6631	6401	1	5
6632	6401	1	4
6633	6401	1	5
6634	6401	1	4
6635	6401	1	5
6636	6401	1	4
6637	6401	1	5
6638	6401	1	5
6639	6401	1	4
6640	6401	1	5
6641	6401	1	5
6642	6401	1	5
6643	6401	1	5
6644	6401	1	5
6645	6401	1	5
6646	6401	1	5
6647	6401	1	5
6648	6401	1	5
6649	6401	1	5
6650	6401	1	5
6651	6401	1	5
6652	6401	1	5
6653	6401	1	5
6654	6401	1	5
6655	6401	1	5
6656	6401	1	5

Postcode	Terminal	Zone in	Zone out
6657	6401	1	5
6658	6401	1	5
6659	6401	1	5
6660	6401	1	5
6661	6401	1	5
6662	6401	1	5
6663	6401	1	5
6664	6401	1	5
6665	6401	1	5
6666	6401	1	5
6667	6401	1	5
6668	6401	1	5
6669	6401	1	5
6670	6401	1	5
6671	6401	1	5
6672	6401	1	5
6673	6401	1	5
6674	6401	1	5
6675	6401	1	5
6676	6401	1	5
6677	6401	1	5
6678	6401	1	5
6679	6401	1	5
6680	6401	1	5
6681	6401	1	5
6682	6401	1	5

Postcode	Terminal	Zone in	Zone out
6683	6401	1	5
6684	6401	1	5
6685	6401	1	5
6686	6401	1	5
6687	6401	1	5
6688	6401	1	5
6689	6401	1	5
6690	6401	1	5
6691	6401	1	5
6692	6401	1	5
6693	6401	1	5
6694	6401	1	5
6695	6401	1	5
6696	6401	1	5
6697	6401	1	5
6698	6401	1	5
6699	6401	1	5
6700	6700	0	4
6701	6700	0	3
6702	6700	0	3
6703	6700	0	3
6704	6880	1	4
6705	6880	1	4
6706	6880	1	4
6707	6880	1	5
6708	6880	1	4

Postcode	Terminal	Zone in	Zone out
6709	6880	1	4
6710	6880	1	5
6711	6880	1	4
6712	6880	1	4
6713	6880	1	4
6714	6880	1	5
6715	6880	1	5
6716	6880	1	5
6717	6880	1	5
6718	6880	1	4
6719	6800	1	5
6720	6880	1	5
6721	6800	1	5
6722	6800	1	5
6723	6800	1	5
6724	6800	1	5
6725	6800	1	5
6726	6800	1	5
6727	6800	1	5
6728	6800	1	5
6729	6800	1	5
6730	6800	1	5
6731	6800	1	5
6732	6800	1	5
6733	6800	1	5
6734	6800	1	5

Postcode	Terminal	Zone in	Zone out
6735	6800	1	5
6736	6800	1	5
6737	6800	1	5
6738	6800	1	5
6739	6800	1	5
6740	6880	1	5
6741	6880	1	5
6742	6880	1	5
6743	6880	1	5
6744	6880	1	5
6745	6880	1	5
6746	6880	1	5
6747	6880	1	5
6748	6880	1	5
6749	6880	1	5
6750	6880	1	5
6751	6880	1	5
6752	6880	1	5
6753	6880	1	5
6754	6880	1	5
6755	6880	1	5
6756	6880	1	5
6757	6880	1	5
6758	6880	1	5
6759	6880	1	5
6760	6880	1	4

Postcode	Terminal	Zone in	Zone out
6761	6880	1	4
6762	6880	1	4
6763	6880	1	5
6764	6880	1	4
6765	6880	1	4
6766	6880	1	4
6767	6880	1	4
6768	6880	1	4
6769	6880	1	4
6770	6880	1	4
6771	6880	1	4
6772	6880	1	4
6773	6880	1	4
6774	6880	1	4
6775	6880	1	4
6776	6880	1	5
6777	6880	1	4
6778	6880	1	5
6779	6880	1	5
6780	6880	0	3
6781	6880	0	3
6782	6880	0	3
6783	6880	0	4
6784	6880	1	4
6785	6880	0	3
6786	6880	1	4

Postcode	Terminal	Zone in	Zone out
6787	6880	1	4
6788	6880	1	5
6789	6880	1	5
6790	6880	1	4
6791	6880	1	5
6792	6880	1	5
6793	6880	1	5
6794	6880	1	4
6795	6880	1	5
6796	6880	1	5
6797	6880	1	5
6798	6880	1	5
6799	6880	1	5
6800	6800	0	3
6801	6800	0	3
6802	6800	0	3
6803	6800	0	3
6804	6800	0	3
6805	6800	0	3
6806	6800	1	4
6807	6800	0	3
6808	6800	0	3
6809	6800	0	3
6810	6800	0	4
6811	6800	0	5
6812	6800	0	3

Postcode	Terminal	Zone in	Zone out
6813	6800	0	3
6814	6800	0	4
6815	6800	0	4
6816	6800	1	4
6817	6800	1	5
6818	6800	1	5
6819	6800	0	4
6820	6800	1	4
6821	6880	1	4
6822	6880	1	4
6823	6880	1	4
6824	6880	1	4
6825	6880	1	4
6826	6880	1	5
6827	6880	1	5
6828	6880	1	5
6829	6880	1	5
6830	6880	1	4
6831	6880	1	4
6832	6800	1	4
6833	6800	1	4
6834	6800	1	4
6835	6800	1	4
6836	6800	1	4
6837	6800	1	4
6838	6800	1	4

Postcode	Terminal	Zone in	Zone out
6839	6800	1	4
6840	6800	1	4
6841	6800	1	4
6842	6800	1	4
6843	6800	1	5
6844	6800	1	4
6845	6800	1	4
6846	6800	1	4
6847	6800	1	5
6848	6800	1	5
6849	6800	0	3
6850	6800	0	3
6851	6800	0	3
6852	6800	0	3
6853	6800	0	3
6854	6800	0	4
6855	6800	1	5
6856	6800	0	4
6857	6800	0	3
6858	6800	0	4
6859	6800	1	4
6860	6800	1	4
6861	6800	1	4
6862	6800	1	4
6863	6800	1	4
6864	6800	1	4

Postcode	Terminal	Zone in	Zone out
6865	6800	1	4
6866	6800	1	4
6867	6800	1	4
6868	6800	1	4
6869	6800	1	4
6870	6800	1	5
6871	6800	1	5
6872	6800	1	5
6873	6800	1	4
6874	6800	1	4
6875	6800	1	4
6876	6800	1	5
6877	6800	1	5
6878	6800	1	5
6879	6800	1	4
6880	6800	1	4
6881	6800	1	4
6882	6800	1	4
6883	6800	1	4
6884	6800	1	4
6885	6800	1	4
6886	6800	1	4
6887	6800	1	5
6888	6800	1	5
6889	6800	1	5
6890	6800	1	4

Postcode	Terminal	Zone in	Zone out
6891	6800	1	4
6892	6800	1	4
6893	6800	1	5
6894	6800	1	4
6895	6800	1	5
6896	6800	1	5
6897	6800	1	4
6898	6800	1	4
6899	6800	1	5
6900	6800	1	4
6901	6800	1	4
6902	6800	1	4
6903	6800	1	4
6904	6800	1	4
6905	6800	1	4
6906	6800	1	4
6907	6800	1	4
6908	6800	1	4
6909	6800	1	4
6910	6800	1	4
6911	6800	1	5
6912	6800	1	5
6913	6800	1	4
6914	6800	1	5
6915	6800	1	5
6916	6800	1	5

Postcode	Terminal	Zone in	Zone out
6917	6800	1	5
6918	6800	1	5
6919	6800	1	5
6920	6800	1	5
6921	6800	1	5
6922	6800	1	5
6923	6800	1	5
6924	6800	1	5
6925	6800	1	5
6926	6800	1	5
6927	6800	1	5
6928	6800	1	5
6929	6800	1	5
6930	6800	1	5
6931	6800	1	5
6932	6800	1	5
6933	6800	1	5
6934	6800	1	5
6935	6800	1	5
6936	6800	1	5
6937	6800	1	5
6938	6800	1	5
6939	6800	1	5
6940	6800	1	5
6941	6800	1	4
6942	6800	1	5

Postcode	Terminal	Zone in	Zone out
6943	6800	1	4
6944	6800	1	5
6945	6800	1	5
6946	6800	1	4
6947	6800	1	5
6948	6800	1	4
6949	6800	1	4
6950	6800	1	4
6951	6800	1	4
6952	6800	1	4
6953	6800	1	5
6954	6800	1	4
6955	6800	1	4
6956	6800	1	4
6957	6800	1	4
6958	6800	1	5
6959	6800	1	4
6960	6800	1	4
6961	6800	1	4
6962	6800	1	4
6963	6800	1	4
6964	6800	1	5
6965	6800	1	5
6966	6800	1	5
6967	6800	1	4
6968	6800	1	5

Postcode	Terminal	Zone in	Zone out
6969	6800	1	4
6970	6800	1	4
6971	6800	1	4
6972	6800	1	4
6973	6800	1	5
6974	6800	1	4
6975	6800	1	4
6976	6800	1	4
6977	6800	1	5
6978	6800	1	5
6979	6800	1	5
6980	6800	1	4
6981	6800	1	4
6982	6800	1	5
6983	6800	1	5
6984	6800	1	5
6985	6800	1	5
6986	6800	1	5
6987	6800	1	5
6988	6800	1	4
6989	6800	1	5
6990	6800	1	5
6991	6800	1	5
6992	6800	1	5
6993	6800	1	5
6994	6800	1	5

Postcode	Terminal	Zone in	Zone out
6995	6800	1	5
6996	6800	1	5
6997	6800	1	4
6998	6800	1	4
6999	6800	1	4
7000	7000	0	3
7001	7000	0	3
7002	7000	0	3
7003	7000	0	3
7004	7000	0	3
7005	7000	0	3
7006	7000	0	3
7007	7000	0	3
7008	7000	0	3
7009	7000	0	3
7010	7000	0	1
7011	7000	0	1
7012	7000	0	1
7013	7000	0	1
7014	7000	0	1
7015	7000	0	1
7016	7000	0	1
7017	7000	0	1
7018	7000	0	2
7019	7000	0	1
7020	7000	0	2

Postcode	Terminal	Zone in	Zone out
7021	7000	0	1
7022	7000	0	1
7023	7000	0	1
7024	7000	0	2
7025	7000	0	1
7026	7000	0	2
7027	7000	0	1
7028	7000	0	1
7029	7000	0	1
7030	7000	0	1
7031	7000	0	1
7032	7000	0	1
7033	7000	0	1
7034	7000	0	1
7035	7000	0	1
7036	7000	0	1
7037	7000	0	1
7038	7000	0	1
7039	7000	0	5
7040	7000	0	2
7041	7000	0	1
7042	7000	0	1
7043	7000	0	1
7044	7000	0	1
7045	7000	0	1
7046	7000	0	1

Postcode	Terminal	Zone in	Zone out
7047	7000	0	1
7048	7000	0	1
7049	7000	0	1
7050	7000	0	1
7051	7000	0	1
7052	7000	0	1
7053	7000	0	1
7054	7000	0	1
7055	7000	0	2
7056	7000	0	1
7057	7000	1	4
7058	7000	0	1
7059	7000	0	1
7060	7000	0	3
7061	7000	0	3
7062	7000	0	3
7063	7000	0	3
7064	7000	0	3
7065	7000	0	3
7066	7000	0	1
7067	7000	0	1
7068	7000	0	1
7069	7000	0	1
7070	7000	1	4
7071	7000	0	1
7072	7000	0	1

Postcode	Terminal	Zone in	Zone out
7073	7000	0	3
7074	7000	1	4
7075	7000	0	1
7076	7000	0	3
7077	7000	0	3
7078	7000	0	1
7079	7000	0	1
7080	7000	0	1
7081	7000	0	1
7082	7000	0	1
7083	7000	1	2
7084	7000	1	4
7085	7000	1	4
7086	7000	1	4
7087	7000	1	5
7088	7000	0	1
7089	7000	0	2
7090	7000	0	3
7091	7000	0	1
7092	7000	0	2
7093	7000	0	1
7094	7000	0	3
7095	7000	0	3
7096	7000	1	5
7097	7000	0	1
7098	7000	0	1

Postcode	Terminal	Zone in	Zone out
7099	7000	0	1
7100	7000	1	5
7101	7000	1	5
7102	7000	1	5
7103	7000	1	5
7104	7000	1	5
7105	7000	1	5
7106	7000	1	5
7107	7000	1	5
7108	7000	1	5
7109	7000	1	5
7110	7000	1	5
7111	7000	1	5
7112	7000	1	5
7113	7000	1	5
7114	7000	1	5
7115	7000	1	5
7116	7000	1	5
7117	7000	1	5
7118	7000	1	5
7119	7000	1	5
7120	7000	1	5
7121	7000	1	5
7122	7000	1	5
7123	7000	1	5
7124	7000	1	5

Postcode	Terminal	Zone in	Zone out
7125	7000	1	5
7126	7000	1	5
7127	7000	1	5
7128	7000	1	5
7129	7000	1	5
7130	7000	1	5
7131	7000	1	5
7132	7000	1	5
7133	7000	1	5
7134	7000	1	5
7135	7000	1	5
7136	7000	1	5
7137	7000	1	5
7138	7000	1	5
7139	7000	1	5
7140	7000	1	5
7141	7000	1	5
7142	7000	1	5
7143	7000	1	5
7144	7000	1	5
7145	7000	1	5
7146	7000	1	5
7147	7000	1	5
7148	7000	1	5
7149	7000	1	5
7150	7000	1	5

Postcode	Terminal	Zone in	Zone out
7151	7000	1	5
7152	7000	1	5
7153	7000	1	5
7154	7000	1	5
7155	7000	1	5
7156	7000	1	5
7157	7000	1	5
7158	7000	1	5
7159	7000	1	5
7160	7000	1	5
7161	7000	1	5
7162	7000	1	5
7163	7000	1	5
7164	7000	1	5
7165	7000	1	5
7166	7000	1	5
7167	7000	1	5
7168	7000	1	5
7169	7000	1	5
7170	7000	1	5
7171	7000	1	5
7172	7000	1	5
7173	7000	1	5
7174	7000	1	5
7175	7000	1	5
7176	7000	1	5

Postcode	Terminal	Zone in	Zone out
7177	7000	1	5
7178	7000	1	5
7179	7000	1	5
7180	7000	1	5
7181	7000	1	5
7182	7000	1	5
7183	7000	1	5
7184	7000	1	5
7185	7000	1	5
7186	7000	1	5
7187	7000	1	5
7188	7000	1	5
7189	7000	1	5
7190	7000	1	5
7191	7000	1	5
7192	7000	1	5
7193	7000	1	5
7194	7000	1	5
7195	7000	1	5
7196	7000	1	5
7197	7000	1	5
7198	7000	1	5
7199	7000	1	5
7200	7000	1	5
7201	7000	1	5
7202	7000	1	5

Postcode	Terminal	Zone in	Zone out
7203	7000	1	5
7204	7000	1	5
7205	7000	1	5
7206	7000	1	5
7207	7000	1	5
7208	7000	1	5
7209	7000	1	5
7210	7000	1	5
7211	7000	1	5
7212	7000	1	5
7213	7000	1	5
7214	7000	1	5
7215	7000	1	5
7216	7000	1	5
7217	7000	1	5
7218	7000	1	5
7219	7000	1	5
7220	7000	1	5
7221	7000	1	4
7222	7000	1	4
7223	7000	1	4
7224	7000	1	4
7225	7000	1	4
7226	7000	1	4
7227	7000	1	5
7228	7000	1	4

Postcode	Terminal	Zone in	Zone out
7229	7000	1	5
7230	7000	1	4
7231	7000	1	4
7232	7000	1	5
7233	7000	1	4
7234	7000	1	4
7235	7000	1	4
7236	7000	1	5
7237	7000	1	4
7238	7000	1	4
7239	7000	1	5
7240	7000	1	5
7241	7000	1	5
7242	7000	1	5
7243	7000	1	5
7244	7000	1	5
7245	7000	1	5
7246	7000	1	5
7247	7000	1	5
7248	7000	1	5
7249	7000	1	5
7250	7000	1	5
7251	7000	1	5
7252	7000	1	5
7253	7000	1	5
7254	7000	1	5

Postcode	Terminal	Zone in	Zone out
7255	7000	1	5
7256	7000	1	5
7257	7000	1	5
7258	7000	1	5
7259	7000	1	5
7260	7000	1	5
7261	7000	1	5
7262	7000	1	5
7263	7000	1	5
7264	7000	1	5
7265	7000	1	5
7266	7000	1	5
7267	7000	1	5
7268	7000	1	5
7269	7000	1	5
7270	7000	1	5
7271	7000	1	5
7272	7000	1	5
7273	7000	1	5
7274	7000	1	5
7275	7000	1	5
7276	7000	1	5
7277	7000	1	5
7278	7000	1	5
7279	7000	1	5
7280	7000	1	5

Postcode	Terminal	Zone in	Zone out
7281	7000	1	5
7282	7000	1	5
7283	7000	1	5
7284	7000	1	5
7285	7000	1	5
7286	7000	1	5
7287	7000	1	5
7288	7000	1	5
7289	7000	1	4
7290	7000	1	4
7291	7000	1	4
7292	7000	1	4
7293	7000	1	4
7294	7000	1	4
7295	7000	1	5
7296	7000	1	5
7297	7000	1	5
7298	7000	1	5
7299	7000	1	5
7300	7000	1	4
7301	7000	1	4
7302	7000	1	4
7303	7000	1	4
7304	7000	1	4
7305	7000	1	4
7306	7000	1	4

Postcode	Terminal	Zone in	Zone out
7307	7000	1	4
7308	7000	1	4
7309	7000	1	4
7310	7000	1	5
7311	7000	1	5
7312	7000	1	5
7313	7000	1	5
7314	7000	1	5
7315	7000	1	5
7316	7000	1	5
7317	7000	1	5
7318	7000	1	5
7319	7000	1	5
7320	7000	1	4
7321	7000	1	4
7322	7000	1	4
7323	7000	1	4
7324	7000	1	4
7325	7000	1	4
7326	7000	1	4
7327	7000	1	4
7328	7000	1	4
7329	7000	1	4
7330	7000	1	5
7331	7000	1	4
7332	7000	1	4

Postcode	Terminal	Zone in	Zone out
7333	7000	1	5
7334	7000	1	5
7335	7000	1	5
7336	7000	1	4
7337	7000	1	4
7338	7000	1	4
7339	7000	1	4
7340	7000	1	5
7341	7000	1	4
7342	7000	1	5
7343	7000	1	5
7344	7000	1	5
7345	7000	1	5
7346	7000	1	5
7347	7000	1	5
7348	7000	1	5
7349	7000	1	5
7350	7000	1	4
7351	7000	1	4
7352	7000	1	4
7353	7000	1	4
7354	7000	1	5
7355	7000	1	5
7356	7000	1	5
7357	7000	1	5
7358	7000	1	4

Postcode	Terminal	Zone in	Zone out
7359	7000	1	4
7360	7000	1	5
7361	7374	1	5
7362	7374	1	5
7363	7374	1	5
7364	7374	1	5
7365	7374	1	5
7366	7374	1	5
7367	7374	1	5
7368	7374	1	5
7369	7374	1	5
7370	7374	1	5
7371	7374	1	5
7372	7374	1	5
7373	7374	1	5
7374	7374	1	5
7375	7374	1	5
7376	7374	1	5
7377	7374	1	5
7378	7374	1	5
7379	7374	1	5
7380	7374	1	5
7381	7374	1	5
7382	7374	1	5
7383	7374	1	5
7384	7374	1	5

Postcode	Terminal	Zone in	Zone out
7385	7000	1	5
7386	7000	1	5
7387	7000	1	5
7388	7000	1	5
7389	7000	1	5
7390	7000	1	4
7391	7000	1	4
7392	7000	1	5
7393	7000	1	5
7394	7000	1	4
7395	7000	1	4
7396	7000	1	4
7397	7000	1	5
7398	7000	1	5
7399	7000	1	4
7400	7000	0	3
7401	7000	0	3
7402	7000	0	3
7403	7000	0	3
7404	7000	0	3
7405	7000	0	3
7406	7000	0	3
7407	7000	0	3
7408	7000	0	3
7409	7000	0	3
7410	7000	0	3

Postcode	Terminal	Zone in	Zone out
7411	7000	0	3
7412	7000	0	3
7413	7000	0	3
7414	7000	0	3
7415	7000	0	3
7416	7000	0	3
7417	7000	0	3
7418	7000	0	3
7419	7000	0	3
7420	7000	0	3
7421	7000	0	3
7422	7000	0	3
7423	7000	0	3
7424	7000	0	3
7425	7000	0	3
7426	7000	0	3
7427	7000	0	3
7428	7000	0	3
7429	7000	0	3
7430	7000	0	3
7431	7000	0	3
7432	7000	0	3
7433	7000	0	3
7434	7000	0	3
7435	7000	0	3
7436	7000	0	3

Postcode	Terminal	Zone in	Zone out
7437	7000	0	3
7438	7000	0	3
7439	7000	0	3
7440	7000	0	3
7441	7000	0	3
7442	7000	0	3
7443	7000	0	3
7444	7000	0	3
7445	7000	0	3
7446	7000	0	3
7447	7000	0	3
7448	7000	0	3
7449	7000	0	3
7450	7000	0	3
7451	7000	0	3
7452	7000	0	3
7453	7000	0	3
7454	7000	0	3
7455	7000	0	3
7456	7000	0	3
7457	7000	0	3
7458	7000	0	3
7459	7000	0	3
7460	7000	0	3
7461	7000	0	3
7462	7000	0	3

Postcode	Terminal	Zone in	Zone out
7463	7000	0	3
7464	7000	0	3
7465	7000	0	3
7466	7000	0	3
7467	7000	0	3
7468	7000	0	3
7469	7000	0	3
7470	7000	0	3
7471	7000	0	3
7472	7000	0	3
7473	7000	0	3
7474	7000	0	3
7475	7000	0	3
7476	7000	0	3
7477	7000	0	3
7478	7000	0	3
7479	7000	0	3
7480	7000	0	3
7481	7000	0	3
7482	7000	0	3
7483	7000	0	3
7484	7000	0	3
7485	7000	0	3
7486	7000	0	3
7487	7000	0	3
7488	7000	0	3

Postcode	Terminal	Zone in	Zone out
7489	7000	0	3
7490	7000	0	3
7491	7000	0	3
7492	7000	0	3
7493	7000	0	3
7494	7000	0	3
7495	7000	0	3
7496	7000	0	3
7497	7000	0	3
7498	7000	0	3
7499	7000	0	3
7500	7000	1	4
7501	7000	1	4
7502	7000	1	4
7503	7000	1	4
7504	7000	1	4
7505	7000	1	3
7506	7000	1	4
7507	7000	1	4
7508	7000	1	4
7509	7000	1	4
7510	7000	1	5
7511	7000	1	4
7512	7000	1	4
7513	7000	1	4
7514	7000	1	4

Postcode	Terminal	Zone in	Zone out
7515	7000	1	4
7516	7000	1	4
7517	7000	1	4
7518	7000	1	4
7519	7000	1	5
7520	7000	1	5
7521	7000	1	4
7522	7000	1	4
7523	7000	1	4
7524	7000	1	4
7525	7000	1	5
7526	7000	1	5
7527	7000	1	5
7528	7000	1	4
7529	7000	1	4
7530	7000	1	5
7531	7000	1	5
7532	7000	1	5
7533	7000	1	5
7534	7000	1	5
7535	7000	1	5
7536	7000	1	5
7537	7000	1	5
7538	7000	1	5
7539	7000	1	5
7540	7000	1	4

Postcode	Terminal	Zone in	Zone out
7541	7000	1	4
7542	7000	1	4
7543	7000	1	4
7544	7000	1	4
7545	7000	1	4
7546	7000	1	4
7547	7000	1	4
7548	7000	1	4
7549	7000	1	4
7550	7000	1	4
7551	7000	1	4
7552	7000	1	4
7553	7000	1	4
7554	7000	1	4
7555	7000	1	4
7556	7000	1	4
7557	7000	1	4
7558	7000	1	4
7559	7000	1	4
7560	7000	1	4
7561	7000	1	4
7562	7000	1	4
7563	7000	1	4
7564	7000	1	4
7565	7000	1	4
7566	7000	1	4

Postcode	Terminal	Zone in	Zone out
7567	7000	1	4
7568	7000	1	4
7569	7000	1	4
7570	7000	1	4
7571	7000	1	4
7572	7000	1	4
7573	7000	1	4
7574	7000	1	4
7575	7000	1	4
7576	7000	1	4
7577	7000	1	4
7578	7000	1	4
7579	7000	1	4
7580	7000	1	5
7581	7000	1	5
7582	7000	1	5
7583	7000	1	5
7584	7000	1	5
7585	7000	1	5
7586	7000	1	5
7587	7000	1	5
7588	7000	1	5
7589	7000	1	5
7590	7000	1	5
7591	7000	1	5
7592	7000	1	5

Postcode	Terminal	Zone in	Zone out
7593	7000	1	5
7594	7000	1	5
7595	7000	1	5
7596	7000	1	5
7597	7000	1	5
7598	7000	1	5
7599	7000	1	5
7600	7000	1	4
7601	7000	1	4
7602	7000	1	4
7603	7000	1	4
7604	7000	1	4
7605	7000	1	4
7606	7000	1	4
7607	7000	1	4
7608	7000	1	5
7609	7000	1	4
7610	7000	1	4
7611	7000	1	4
7612	7000	1	4
7613	7000	1	4
7614	7000	1	4
7615	7000	1	4
7616	7000	1	4
7617	7000	1	4
7618	7000	1	4

Postcode	Terminal	Zone in	Zone out
7619	7000	1	4
7620	7000	1	4
7621	7000	1	5
7622	7000	1	5
7623	7000	1	5
7624	7000	1	5
7625	7000	1	5
7626	7000	1	5
7627	7000	1	5
7628	7000	1	5
7629	7000	1	5
7630	7000	1	5
7631	7000	1	5
7632	7000	1	5
7633	7000	1	5
7634	7000	1	5
7635	7000	1	5
7636	7000	1	5
7637	7000	1	5
7638	7000	1	5
7639	7000	1	5
7640	7000	1	4
7641	7000	1	4
7642	7000	1	4
7643	7000	1	4
7644	7000	1	4

Postcode	Terminal	Zone in	Zone out
7645	7000	1	4
7646	7000	1	4
7647	7000	1	4
7648	7000	1	4
7649	7000	1	4
7650	7000	1	3
7651	7000	1	4
7652	7000	1	4
7653	7000	1	4
7654	7000	1	4
7655	7000	1	4
7656	7000	1	4
7657	7000	1	4
7658	7000	1	4
7659	7000	1	5
7660	7000	1	5
7661	7000	1	5
7662	7000	1	5
7663	7000	1	5
7664	7000	1	5
7665	7000	1	5
7666	7000	1	5
7667	7000	1	5
7668	7000	1	5
7669	7000	1	5
7670	7000	1	5

Postcode	Terminal	Zone in	Zone out
7671	7000	1	5
7672	7000	1	5
7673	7000	1	5
7674	7000	1	5
7675	7000	1	5
7676	7000	1	5
7677	7000	1	5
7678	7000	1	5
7679	7000	1	5
7680	7000	1	5
7681	7000	1	5
7682	7000	1	5
7683	7000	1	5
7684	7000	1	5
7685	7000	1	5
7686	7000	1	5
7687	7000	1	5
7688	7000	1	5
7689	7000	1	5
7690	7000	1	5
7691	7000	1	5
7692	7000	1	5
7693	7000	1	5
7694	7000	1	5
7695	7000	1	5
7696	7000	1	5

Postcode	Terminal	Zone in	Zone out
7697	7000	1	5
7698	7000	1	5
7699	7000	1	5
7700	7000	1	4
7701	7000	1	4
7702	7000	1	4
7703	7000	1	4
7704	7000	1	4
7705	7000	1	4
7706	7000	1	4
7707	7000	1	4
7708	7000	1	4
7709	7000	1	4
7710	7000	1	5
7711	7000	1	5
7712	7000	1	4
7713	7000	1	3
7714	7000	1	4
7715	7000	1	4
7716	7000	1	4
7717	7000	1	5
7718	7000	1	5
7719	7000	1	4
7720	7000	1	4
7721	7000	1	4
7722	7000	1	4

Postcode	Terminal	Zone in	Zone out
7723	7000	1	4
7724	7000	1	5
7725	7000	1	4
7726	7000	1	4
7727	7000	1	4
7728	7000	1	5
7729	7000	1	4
7730	7000	1	5
7731	7000	1	4
7732	7000	1	5
7733	7000	1	4
7734	7000	1	4
7735	7000	1	4
7736	7000	1	4
7737	7000	1	4
7738	7000	1	4
7739	7000	1	5
7740	7000	1	5
7741	7000	1	5
7742	7000	1	5
7743	7000	1	5
7744	7000	1	5
7745	7000	1	5
7746	7000	1	5
7747	7000	1	5
7748	7000	1	5

Postcode	Terminal	Zone in	Zone out
7749	7000	1	5
7750	7000	1	5
7751	7000	1	5
7752	7000	1	5
7753	7000	1	5
7754	7000	1	5
7755	7000	1	5
7756	7000	1	5
7757	7000	1	5
7758	7000	1	5
7759	7000	1	5
7760	7000	1	5
7761	7000	1	5
7762	7000	1	5
7763	7000	1	5
7764	7000	1	5
7765	7000	1	5
7766	7000	1	5
7767	7000	1	5
7768	7000	1	5
7769	7000	1	5
7770	7000	1	5
7771	7000	1	5
7772	7000	1	5
7773	7000	1	5
7774	7000	1	5

Postcode	Terminal	Zone in	Zone out
7775	7000	1	5
7776	7000	1	5
7777	7000	1	5
7778	7000	1	5
7779	7000	1	5
7780	7000	1	5
7781	7000	1	5
7782	7000	1	5
7783	7000	1	5
7784	7000	1	5
7785	7000	1	5
7786	7000	1	5
7787	7000	1	5
7788	7000	1	5
7789	7000	1	5
7790	7000	1	5
7791	7000	1	5
7792	7000	1	5
7793	7000	1	5
7794	7000	1	5
7795	7000	1	5
7796	7000	1	5
7797	7000	1	5
7798	7000	1	5
7799	7000	1	5
7800	7000	1	5

Postcode	Terminal	Zone in	Zone out
7801	7000	1	5
7802	7000	1	5
7803	7000	1	5
7804	7000	1	5
7805	7000	1	5
7806	7000	1	5
7807	7000	1	5
7808	7000	1	5
7809	7000	1	5
7810	7000	1	5
7811	7000	1	5
7812	7000	1	5
7813	7000	1	5
7814	7000	1	5
7815	7000	1	5
7816	7000	1	5
7817	7000	1	5
7818	7000	1	5
7819	7000	1	5
7820	7000	1	5
7821	7000	1	5
7822	7000	1	5
7823	7000	1	5
7824	7000	1	5
7825	7000	1	5
7826	7000	1	5

Postcode	Terminal	Zone in	Zone out
7827	7000	1	5
7828	7000	1	5
7829	7000	1	5
7830	7000	1	5
7831	7000	1	5
7832	7000	1	5
7833	7000	1	5
7834	7000	1	5
7835	7000	1	5
7836	7000	1	5
7837	7000	1	5
7838	7000	1	5
7839	7000	1	5
7840	7000	1	5
7841	7000	1	5
7842	7000	1	5
7843	7000	1	5
7844	7000	1	5
7845	7000	1	5
7846	7000	1	5
7847	7000	1	5
7848	7000	1	5
7849	7000	1	5
7850	7000	1	5
7851	7000	1	5
7852	7000	1	5

Postcode	Terminal	Zone in	Zone out
7853	7000	1	5
7854	7000	1	5
7855	7000	1	5
7856	7000	1	5
7857	7000	1	5
7858	7000	1	5
7859	7000	1	5
7860	7000	1	5
7861	7000	1	5
7862	7000	1	5
7863	7000	1	5
7864	7000	1	5
7865	7000	1	5
7866	7000	1	5
7867	7000	1	5
7868	7000	1	5
7869	7000	1	5
7870	7000	1	5
7871	7000	1	5
7872	7000	1	5
7873	7000	1	5
7874	7000	1	5
7875	7000	1	5
7876	7000	1	5
7877	7000	1	5
7878	7000	1	5

Postcode	Terminal	Zone in	Zone out
7879	7000	1	5
7880	7000	1	5
7881	7000	1	5
7882	7000	1	5
7883	7000	1	5
7884	7000	1	5
7885	7000	1	5
7886	7000	1	5
7887	7000	1	5
7888	7000	1	5
7889	7000	1	5
7890	7000	1	5
7891	7000	1	5
7892	7000	1	5
7893	7000	1	5
7894	7000	1	5
7895	7000	1	5
7896	7000	1	5
7897	7000	1	5
7898	7000	1	5
7899	7000	1	5
7900	7000	1	5
7901	7000	1	5
7902	7000	1	5
7903	7000	1	5
7904	7000	1	5

Postcode	Terminal	Zone in	Zone out
7905	7000	1	5
7906	7000	1	5
7907	7000	1	5
7908	7000	1	5
7909	7000	1	5
7910	7000	1	5
7911	7000	1	5
7912	7000	1	5
7913	7000	1	5
7914	7000	1	5
7915	7000	1	5
7916	7000	1	5
7917	7000	1	5
7918	7000	1	5
7919	7000	1	5
7920	7000	1	5
7921	7000	1	5
7922	7000	1	5
7923	7000	1	5
7924	7000	1	5
7925	7000	1	5
7926	7000	1	5
7927	7000	1	5
7928	7000	1	5
7929	7000	1	5
7930	7000	1	5

Postcode	Terminal	Zone in	Zone out
7931	7000	1	5
7932	7000	1	5
7933	7000	1	5
7934	7000	1	5
7935	7000	1	5
7936	7000	1	5
7937	7000	1	5
7938	7000	1	5
7939	7000	1	5
7940	7000	1	5
7941	7000	1	5
7942	7000	1	5
7943	7000	1	5
7944	7000	1	5
7945	7000	1	5
7946	7000	1	5
7947	7000	1	5
7948	7000	1	5
7949	7000	1	5
7950	7000	1	5
7951	7000	1	5
7952	7000	1	5
7953	7000	1	5
7954	7000	1	5
7955	7000	1	5
7956	7000	1	5

Postcode	Terminal	Zone in	Zone out
7957	7000	1	5
7958	7000	1	5
7959	7000	1	5
7960	7000	1	5
7961	7000	1	5
7962	7000	1	5
7963	7000	1	5
7964	7000	1	5
7965	7000	1	5
7966	7000	1	5
7967	7000	1	5
7968	7000	1	5
7969	7000	1	5
7970	7000	1	5
7971	7000	1	5
7972	7000	1	5
7973	7000	1	5
7974	7000	1	5
7975	7000	1	5
7976	7000	1	5
7977	7000	1	5
7978	7000	1	5
7979	7000	1	5
7980	7000	1	5
7981	7000	1	5
7982	7000	1	5

Postcode	Terminal	Zone in	Zone out
7983	7000	1	5
7984	7000	1	5
7985	7000	1	5
7986	7000	1	5
7987	7000	1	5
7988	7000	1	5
7989	7000	1	5
7990	7000	1	5
7991	7000	1	5
7992	7000	1	5
7993	7000	1	5
7994	7000	1	5
7995	7000	1	5
7996	7000	1	5
7997	7000	1	5
7998	7000	1	5
7999	7000	1	5
8000	8000	0	3
8001	8000	0	3
8002	8000	0	3
8003	8000	0	3
8004	8000	0	3
8005	8000	0	3
8006	8000	0	3
8007	8000	0	3
8008	8000	0	3

Postcode	Terminal	Zone in	Zone out
8009	8000	0	3
8010	8000	0	3
8011	8000	0	4
8012	8000	0	3
8013	8000	0	3
8014	8000	0	3
8015	8000	0	3
8016	8000	1	4
8017	8000	0	3
8018	8000	0	3
8019	8000	0	3
8020	8000	0	4
8021	8000	0	3
8022	8000	0	3
8023	8000	0	3
8024	8000	0	3
8025	8000	0	3
8026	8000	0	3
8027	8000	0	3
8028	8000	0	3
8029	8000	0	3
8030	8000	0	4
8031	8000	0	3
8032	8000	0	3
8033	8000	0	3
8034	8000	0	3

Postcode	Terminal	Zone in	Zone out
8035	8000	0	3
8036	8000	0	3
8037	8000	0	3
8038	8000	0	3
8039	8000	0	3
8040	8000	0	3
8041	8000	0	3
8042	8000	0	3
8043	8000	0	3
8044	8000	0	3
8045	8000	0	3
8046	8000	0	3
8047	8000	0	3
8048	8000	0	3
8049	8000	0	3
8050	8000	1	4
8051	8000	1	4
8052	8000	1	4
8053	8000	1	4
8054	8000	1	4
8055	8000	1	4
8056	8000	1	5
8057	8000	1	4
8058	8000	1	4
8059	8000	1	4
8060	8000	1	4

Postcode	Terminal	Zone in	Zone out
8061	8000	1	4
8062	8000	1	4
8063	8000	1	5
8064	8000	1	5
8065	8000	1	5
8066	8000	1	5
8067	8000	1	5
8068	8000	1	5
8069	8000	1	5
8070	8000	0	3
8071	8000	0	3
8072	8000	0	3
8073	8000	0	4
8074	8000	0	3
8075	8000	0	3
8076	8000	0	3
8077	8000	0	3
8078	8000	0	3
8079	8000	0	3
8080	8000	0	3
8081	8000	0	3
8082	8000	0	3
8083	8000	0	3
8084	8000	0	3
8085	8000	0	3
8086	8000	0	3

Postcode	Terminal	Zone in	Zone out
8087	8000	0	3
8088	8000	0	3
8089	8000	0	3
8090	8000	0	3
8091	8000	0	3
8092	8000	0	3
8093	8000	1	5
8094	8000	1	5
8095	8000	1	5
8096	8000	1	5
8097	8000	1	5
8098	8000	1	5
8099	8000	1	5
8100	8000	1	5
8101	8000	1	5
8102	8000	1	5
8103	8000	1	5
8104	8000	1	5
8105	8000	1	5
8106	8000	1	5
8107	8000	1	5
8108	8000	1	5
8109	8000	1	5
8110	8000	1	5
8111	8000	1	5
8112	8000	1	5

Postcode	Terminal	Zone in	Zone out
8113	8000	1	5
8114	8000	1	5
8115	8000	1	5
8116	8000	1	5
8117	8000	1	5
8118	8000	1	5
8119	8000	1	5
8120	8000	1	5
8121	8000	1	4
8122	8000	1	4
8123	8000	1	4
8124	8000	1	5
8125	8000	1	5
8126	8000	1	5
8127	8000	1	5
8128	8000	1	5
8129	8000	1	5
8130	8000	1	5
8131	8000	1	5
8132	8000	1	5
8133	8000	1	5
8134	8000	1	5
8135	8000	1	5
8136	8000	1	5
8137	8000	1	5
8138	8000	1	5

Postcode	Terminal	Zone in	Zone out
8139	8000	1	5
8140	8000	1	5
8141	8000	1	5
8142	8000	1	5
8143	8000	1	5
8144	8000	1	5
8145	8000	1	5
8146	8000	1	5
8147	8000	1	5
8148	8000	1	5
8149	8000	1	5
8150	8000	1	5
8151	8000	1	5
8152	8000	1	5
8153	8000	1	5
8154	8000	1	5
8155	8000	1	5
8156	8000	1	5
8157	8000	1	5
8158	8000	1	5
8159	8000	1	5
8160	8000	1	5
8161	8000	1	5
8162	8000	1	5
8163	8000	1	5
8164	8000	1	5

Postcode	Terminal	Zone in	Zone out
8165	8000	1	5
8166	8000	1	5
8167	8000	1	5
8168	8000	1	5
8169	8000	1	5
8170	8000	1	5
8171	8000	1	5
8172	8000	1	5
8173	8000	1	5
8174	8000	1	5
8175	8000	1	5
8176	8000	1	5
8177	8000	1	5
8178	8000	1	5
8179	8000	1	5
8180	8000	1	5
8181	8000	1	5
8182	8000	1	5
8183	8000	1	5
8184	8000	1	5
8185	8000	1	5
8186	8000	1	5
8187	8000	1	5
8188	8000	1	5
8189	8000	1	5
8190	8000	1	5

Postcode	Terminal	Zone in	Zone out
8191	8000	1	5
8192	8000	1	5
8193	8000	1	5
8194	8000	1	5
8195	8000	1	5
8196	8000	1	5
8197	8000	1	5
8198	8000	1	5
8199	8000	1	5
8200	8000	0	3
8201	8000	0	3
8202	8000	0	3
8203	8000	0	3
8204	8000	0	3
8205	8000	0	3
8206	8000	0	4
8207	8000	0	3
8208	8000	0	3
8209	8000	0	3
8210	8000	0	3
8211	8000	0	5
8212	8000	0	3
8213	8000	0	3
8214	8000	0	5
8215	8000	1	5
8216	8000	1	4

Postcode	Terminal	Zone in	Zone out
8217	8000	0	3
8218	8000	0	4
8219	8000	0	5
8220	8000	1	5
8221	8000	1	5
8222	8000	1	5
8223	8000	1	5
8224	8000	1	4
8225	8000	1	4
8226	8000	1	5
8227	8000	1	4
8228	8000	1	4
8229	8000	1	4
8230	8000	1	5
8231	8000	1	5
8232	8000	1	4
8233	8000	1	4
8234	8000	1	4
8235	8000	1	4
8236	8000	1	4
8237	8000	1	4
8238	8000	1	4
8239	8000	1	4
8240	8000	1	5
8241	8000	1	5
8242	8000	1	5

Postcode	Terminal	Zone in	Zone out
8243	8000	1	5
8244	8000	1	5
8245	8000	1	5
8246	8000	1	5
8247	8000	1	5
8248	8000	1	5
8249	8000	1	5
8250	8000	1	4
8251	8000	1	4
8252	8000	1	4
8253	8000	1	4
8254	8000	1	4
8255	8000	1	5
8256	8000	1	5
8257	8000	1	5
8258	8000	1	5
8259	8000	1	5
8260	8000	1	5
8261	8000	1	5
8262	8000	1	5
8263	8000	1	5
8264	8000	1	5
8265	8000	1	5
8266	8000	1	5
8267	8000	1	5
8268	8000	1	5

Postcode	Terminal	Zone in	Zone out
8269	8000	1	5
8270	8000	1	5
8271	8000	1	5
8272	8000	1	5
8273	8000	1	5
8274	8000	1	5
8275	8000	1	5
8276	8000	1	5
8277	8000	1	5
8278	8000	1	5
8279	8000	1	5
8280	8000	1	5
8281	8000	1	5
8282	8000	1	5
8283	8000	1	5
8284	8000	1	5
8285	8000	1	5
8286	8000	1	5
8287	8000	1	5
8288	8000	1	5
8289	8000	1	5
8290	8000	1	5
8291	8000	1	5
8292	8000	1	5
8293	8000	1	5
8294	8000	1	5

Postcode	Terminal	Zone in	Zone out
8295	8000	1	5
8296	8000	1	5
8297	8000	1	5
8298	8000	1	5
8299	8000	1	5
8300	8371	1	4
8301	8371	1	4
8302	8371	1	4
8303	8371	1	4
8304	8371	1	4
8305	8371	1	4
8306	8371	1	4
8307	8371	1	4
8308	8371	1	4
8309	8371	1	4
8310	8371	1	4
8311	8371	1	4
8312	8371	1	4
8313	8371	1	5
8314	8371	1	5
8315	8371	1	5
8316	8371	1	5
8317	8371	1	5
8318	8371	1	5
8319	8371	1	5
8320	8371	1	5

Postcode	Terminal	Zone in	Zone out
8321	8371	1	5
8322	8371	1	5
8323	8371	1	5
8324	8371	1	5
8325	8371	1	5
8326	8371	1	5
8327	8371	1	4
8328	8371	1	5
8329	8371	1	5
8330	8371	1	5
8331	8371	1	5
8332	8371	1	5
8333	8371	1	5
8334	8371	1	5
8335	8371	1	5
8336	8371	1	5
8337	8371	1	5
8338	8371	1	5
8339	8371	1	5
8340	8371	1	4
8341	8371	1	4
8342	8371	1	4
8343	8371	1	4
8344	8371	1	4
8345	8371	1	4
8346	8371	1	4

Postcode	Terminal	Zone in	Zone out
8347	8371	1	4
8348	8371	1	4
8349	8371	1	4
8350	8371	1	4
8351	8371	1	4
8352	8371	1	5
8353	8371	1	4
8354	8371	1	4
8355	8371	1	4
8356	8371	1	4
8357	8371	1	5
8358	8371	1	4
8359	8371	1	4
8360	8371	1	5
8361	8371	1	4
8362	8371	1	4
8363	8371	1	4
8364	8371	1	4
8365	8371	1	4
8366	8371	1	4
8367	8371	1	4
8368	8371	1	4
8369	8371	1	4
8370	8371	0	4
8371	8371	0	3
8372	8371	0	4

Postcode	Terminal	Zone in	Zone out
8373	8371	1	4
8374	8371	1	4
8375	8371	0	3
8376	8371	0	3
8377	8371	0	3
8378	8371	1	4
8379	8371	1	4
8380	8371	1	4
8381	8371	1	4
8382	8371	1	5
8383	8371	1	4
8384	8371	1	4
8385	8371	1	4
8386	8371	1	4
8387	8371	1	5
8388	8371	1	4
8389	8371	1	4
8390	8371	1	5
8391	8371	1	5
8392	8371	1	5
8393	8371	1	5
8394	8371	1	5
8395	8371	1	5
8396	8371	1	5
8397	8371	1	5
8398	8371	1	5

Postcode	Terminal	Zone in	Zone out
8399	8371	1	5
8400	8403	0	4
8401	8403	0	3
8402	8403	0	3
8403	8403	0	3
8404	8403	0	4
8405	8403	0	3
8406	8403	0	5
8407	8403	0	5
8408	8403	0	5
8409	8403	1	5
8410	8510	1	5
8411	8510	1	5
8412	8510	1	5
8413	8403	1	5
8414	8403	1	5
8415	8403	0	5
8416	8403	0	5
8417	8403	0	3
8418	8403	0	3
8419	8403	0	3
8420	8403	1	5
8421	8403	1	5
8422	8403	1	5
8423	8403	1	5
8424	8403	1	5

Postcode	Terminal	Zone in	Zone out
8425	8403	1	5
8426	8403	1	5
8427	8403	1	5
8428	8403	1	5
8429	8403	1	5
8430	8403	1	4
8431	8403	1	4
8432	8403	1	4
8433	8403	1	4
8434	8403	1	4
8435	8403	1	4
8436	8403	1	4
8437	8403	1	4
8438	8403	1	5
8439	8403	1	4
8440	8403	1	4
8441	8403	1	4
8442	8403	1	4
8443	8403	1	4
8444	8403	1	4
8445	8403	1	4
8446	8403	1	4
8447	8403	1	5
8448	8403	1	4
8449	8403	1	4
8450	8403	1	4

Postcode	Terminal	Zone in	Zone out
8451	8403	1	4
8452	8403	1	4
8453	8403	1	4
8454	8403	1	4
8455	8403	1	4
8456	8403	1	4
8457	8403	1	4
8458	8403	1	4
8459	8403	1	4
8460	8403	1	5
8461	8403	1	5
8462	8403	1	5
8463	8403	1	5
8464	8403	1	5
8465	8403	1	5
8466	8403	1	5
8467	8403	1	5
8468	8403	1	4
8469	8403	1	4
8470	8403	1	4
8471	8403	1	4
8472	8403	1	4
8473	8403	1	5
8474	8403	1	5
8475	8403	1	5
8476	8403	1	5

Postcode	Terminal	Zone in	Zone out
8477	8403	1	5
8478	8403	1	4
8479	8403	1	4
8480	8403	1	4
8481	8403	1	4
8482	8403	1	4
8483	8403	1	4
8484	8403	1	5
8485	8403	1	5
8486	8403	1	4
8487	8403	1	4
8488	8403	1	5
8489	8403	1	5
8490	8403	1	4
8491	8403	1	4
8492	8403	1	4
8493	8403	1	4
8494	8403	1	4
8495	8403	1	4
8496	8403	1	4
8497	8403	1	4
8498	8403	1	4
8499	8403	1	4
8500	8510	0	3
8501	8510	0	3
8502	8510	0	3

Postcode	Terminal	Zone in	Zone out
8503	8510	0	3
8504	8510	0	3
8505	8510	0	3
8506	8510	0	3
8507	8510	0	3
8508	8510	0	3
8509	8510	0	3
8510	8510	0	3
8511	8510	0	3
8512	8510	0	3
8513	8510	0	3
8514	8510	0	3
8515	8510	0	3
8516	8510	0	3
8517	8510	0	4
8518	8510	0	3
8519	8510	0	3
8520	8510	0	5
8521	8510	0	3
8522	8510	1	4
8523	8510	1	5
8524	8510	1	4
8525	8510	1	4
8526	8510	1	4
8527	8510	1	4
8528	8510	1	4

Postcode	Terminal	Zone in	Zone out
8529	8510	1	4
8530	8510	0	4
8531	8510	0	3
8532	8510	0	3
8533	8510	1	5
8534	8510	1	5
8535	8510	1	5
8536	8510	1	4
8537	8510	1	4
8538	8510	1	4
8539	8510	1	5
8540	8510	1	5
8541	8510	1	4
8542	8510	1	4
8543	8510	1	5
8544	8510	1	5
8545	8510	1	4
8546	8510	1	4
8547	8510	1	4
8548	8510	1	4
8549	8510	1	4
8550	8510	1	4
8551	8510	1	4
8552	8510	1	4
8553	8510	1	4
8554	8510	1	4

Postcode	Terminal	Zone in	Zone out
8555	8510	1	4
8556	8510	1	4
8557	8510	1	4
8558	8510	1	4
8559	8510	1	4
8560	8510	1	4
8561	8510	1	4
8562	8510	1	4
8563	8510	1	4
8564	8510	1	4
8565	8510	1	4
8566	8510	1	4
8567	8510	1	4
8568	8510	1	4
8569	8510	1	4
8570	8510	1	5
8571	8510	1	5
8572	8510	1	5
8573	8510	1	5
8574	8510	1	5
8575	8510	1	5
8576	8510	1	5
8577	8510	1	5
8578	8510	1	5
8579	8510	1	5
8580	8510	1	5

Postcode	Terminal	Zone in	Zone out
8581	8510	1	5
8582	8510	1	5
8583	8510	1	5
8584	8510	1	5
8585	8510	1	5
8586	8510	1	5
8587	8510	1	5
8588	8510	1	5
8589	8510	1	5
8590	8510	1	5
8591	8510	1	5
8592	8510	1	5
8593	8510	1	5
8594	8510	1	5
8595	8510	1	5
8596	8510	1	5
8597	8510	1	5
8598	8510	1	5
8599	8510	1	5
8600	8600	0	3
8601	8600	0	3
8602	8600	0	3
8603	8600	0	3
8604	8600	0	3
8605	8600	0	3
8606	8600	0	3

Postcode	Terminal	Zone in	Zone out
8607	8600	0	3
8608	8600	0	3
8609	8600	0	3
8610	8600	0	4
8611	8600	0	3
8612	8600	0	3
8613	8600	0	4
8614	8600	0	4
8615	8600	1	5
8616	8600	0	4
8617	8600	1	5
8618	8600	0	5
8619	8600	0	3
8620	8600	0	3
8621	8600	0	3
8622	8600	0	4
8623	8600	0	3
8624	8600	0	3
8625	8600	0	3
8626	8600	0	3
8627	8600	0	3
8628	8600	0	3
8629	8600	0	3
8630	8600	1	5
8631	8600	1	4
8632	8600	0	3

Postcode	Terminal	Zone in	Zone out
8633	8600	0	3
8634	8600	0	3
8635	8600	0	3
8636	8600	0	3
8637	8600	0	3
8638	8600	1	4
8639	8600	1	4
8640	8600	1	4
8641	8600	1	4
8642	8600	1	5
8643	8600	1	5
8644	8600	1	4
8645	8600	1	4
8646	8600	1	5
8647	8600	1	5
8648	8600	1	4
8649	8600	1	4
8650	8600	1	4
8651	8600	1	4
8652	8600	1	4
8653	8600	1	4
8654	8600	1	4
8655	8600	1	4
8656	8600	1	4
8657	8600	1	3
8658	8600	1	5

Postcode	Terminal	Zone in	Zone out
8659	8600	1	5
8660	8600	1	4
8661	8600	1	3
8662	8600	1	4
8663	8600	1	4
8664	8600	1	5
8665	8600	1	4
8666	8600	1	4
8667	8600	1	4
8668	8600	1	4
8669	8600	1	4
8670	8600	1	5
8671	8600	1	5
8672	8600	1	5
8673	8600	1	5
8674	8600	1	5
8675	8600	1	5
8676	8600	1	5
8677	8600	1	5
8678	8600	1	5
8679	8600	1	5
8680	8600	1	5
8681	8600	1	5
8682	8600	1	5
8683	8600	1	5
8684	8600	1	5

Postcode	Terminal	Zone in	Zone out
8685	8600	1	5
8686	8600	1	5
8687	8600	1	5
8688	8600	1	5
8689	8600	1	5
8690	8600	1	5
8691	8600	1	5
8692	8600	1	5
8693	8600	1	5
8694	8600	1	5
8695	8600	1	5
8696	8600	1	5
8697	8600	1	5
8698	8600	1	5
8699	8600	1	5
8700	8600	1	5
8701	8600	1	5
8702	8600	1	5
8703	8600	1	5
8704	8600	1	5
8705	8600	1	5
8706	8600	1	5
8707	8600	1	5
8708	8600	1	5
8709	8600	1	5
8710	8600	1	5

Postcode	Terminal	Zone in	Zone out
8711	8600	1	5
8712	8600	1	5
8713	8600	1	5
8714	8600	1	5
8715	8600	1	5
8716	8600	1	5
8717	8600	1	5
8718	8600	1	5
8719	8600	1	5
8720	8600	1	5
8721	8600	1	5
8722	8600	1	5
8723	8600	1	5
8724	8600	1	5
8725	8600	1	5
8726	8600	1	5
8727	8600	1	5
8728	8600	1	5
8729	8600	1	5
8730	8600	1	5
8731	8600	1	5
8732	8600	1	5
8733	8600	1	5
8734	8600	1	5
8735	8600	1	5
8736	8600	1	5

Postcode	Terminal	Zone in	Zone out
8737	8600	1	5
8738	8600	1	5
8739	8600	1	5
8740	8600	1	5
8741	8600	1	5
8742	8600	1	5
8743	8600	1	5
8744	8600	1	5
8745	8600	1	5
8746	8600	1	5
8747	8600	1	5
8748	8600	1	5
8749	8600	1	5
8750	8600	1	5
8751	8600	1	5
8752	8600	1	5
8753	8600	1	5
8754	8600	1	5
8755	8600	1	5
8756	8600	1	5
8757	8600	1	5
8758	8600	1	5
8759	8600	1	5
8760	8600	1	5
8761	8600	1	5
8762	8600	1	5

Postcode	Terminal	Zone in	Zone out
8763	8600	1	5
8764	8600	1	5
8765	8600	1	5
8766	8600	1	5
8767	8600	1	5
8768	8600	1	5
8769	8600	1	5
8770	8600	1	5
8771	8600	1	5
8772	8600	1	5
8773	8600	1	5
8774	8600	1	5
8775	8600	1	5
8776	8600	1	5
8777	8600	1	5
8778	8600	1	5
8779	8600	1	5
8780	8600	1	5
8781	8600	1	5
8782	8600	1	5
8783	8600	1	5
8784	8600	1	5
8785	8600	1	5
8786	8600	1	5
8787	8600	1	5
8788	8600	1	5

Postcode	Terminal	Zone in	Zone out
8789	8600	1	5
8790	8600	1	5
8791	8600	1	5
8792	8600	1	5
8793	8600	1	5
8794	8600	1	5
8795	8600	1	5
8796	8600	1	5
8797	8600	1	5
8798	8600	1	5
8799	8600	1	5
8800	8800	0	4
8801	8800	0	3
8802	8800	0	3
8803	8800	0	4
8804	8800	0	5
8805	8800	0	3
8806	8800	0	3
8807	8800	0	3
8808	8800	0	3
8809	8800	0	3
8810	8800	0	3
8811	8800	0	3
8812	8800	1	5
8813	8800	1	5
8814	8800	1	5

Postcode	Terminal	Zone in	Zone out
8815	8800	1	5
8816	8800	1	5
8817	8800	1	5
8818	8800	1	5
8819	8800	1	5
8820	8800	1	5
8821	8800	1	5
8822	8800	1	5
8823	8800	1	5
8824	8800	1	5
8825	8800	1	5
8826	8800	1	5
8827	8800	1	5
8828	8800	1	5
8829	8800	1	5
8830	8800	1	5
8831	8800	1	5
8832	8800	1	5
8833	8800	1	5
8834	8800	1	5
8835	8800	1	5
8836	8800	1	5
8837	8800	1	5
8838	8800	1	5
8839	8800	1	5
8840	8800	1	5

Postcode	Terminal	Zone in	Zone out
8841	8800	1	5
8842	8800	1	5
8843	8800	1	5
8844	8800	1	5
8845	8800	1	5
8846	8800	1	5
8847	8800	1	5
8848	8800	1	5
8849	8800	1	5
8850	8800	1	5
8851	8800	1	5
8852	8800	1	5
8853	8800	1	5
8854	8800	1	5
8855	8800	1	5
8856	8800	1	5
8857	8800	1	5
8858	8800	1	5
8859	8800	1	5
8860	8800	1	5
8861	8800	1	5
8862	8800	1	5
8863	8800	1	5
8864	8800	1	5
8865	8800	1	5
8866	8800	1	4

Postcode	Terminal	Zone in	Zone out
8867	8800	1	4
8868	8800	1	4
8869	8800	1	4
8870	8800	1	5
8871	8800	1	5
8872	8800	1	5
8873	8800	1	5
8874	8800	1	5
8875	8800	1	5
8876	8800	1	5
8877	8800	1	5
8878	8800	1	5
8879	8800	1	5
8880	8800	1	5
8881	8800	1	5
8882	8800	1	5
8883	8800	1	5
8884	8800	1	5
8885	8800	1	5
8886	8800	1	5
8887	8800	1	5
8888	8800	1	5
8889	8800	1	5
8890	8800	1	5
8891	8800	1	5
8892	8600	1	5

Postcode	Terminal	Zone in	Zone out
8893	8800	1	5
8894	8800	1	5
8895	8800	1	5
8896	8800	1	5
8897	8800	1	5
8898	8800	1	5
8899	8800	1	5
8900	8910	0	3
8901	8910	0	3
8902	8910	0	3
8903	8910	0	3
8904	8910	0	4
8905	8910	0	3
8906	8910	0	4
8907	8910	0	3
8908	8910	0	5
8909	8910	0	4
8910	8910	0	3
8911	8910	0	3
8912	8910	0	3
8913	8910	0	3
8914	8910	0	3
8915	8910	0	3
8916	8910	0	3
8917	8910	0	3
8918	8910	0	3

Postcode	Terminal	Zone in	Zone out
8919	8910	0	3
8920	8910	1	4
8921	8910	1	4
8922	8910	1	4
8923	8910	1	4
8924	8910	1	4
8925	8910	1	4
8926	8910	1	4
8927	8910	1	4
8928	8910	1	4
8929	8910	1	4
8930	8910	1	4
8931	8910	1	4
8932	8910	1	4
8933	8910	1	4
8934	8910	1	4
8935	8910	1	4
8936	8910	1	4
8937	8910	1	4
8938	8910	1	4
8939	8910	1	4
8940	8910	1	4
8941	8910	1	4
8942	8910	1	4
8943	8910	1	4
8944	8910	1	4

Postcode	Terminal	Zone in	Zone out
8945	8910	1	4
8946	8910	1	4
8947	8910	1	4
8948	8910	1	4
8949	8910	1	4
8950	8910	1	4
8951	8910	1	4
8952	8910	1	4
8953	8910	1	4
8954	8910	1	4
8955	8910	1	4
8956	8910	1	4
8957	8910	1	4
8958	8910	1	4
8959	8910	1	4
8960	8910	1	5
8961	8910	1	4
8962	8910	1	4
8963	8910	1	4
8964	8910	1	4
8965	8910	1	4
8966	8910	1	4
8967	8910	1	4
8968	8910	1	4
8969	8910	1	4
8970	8910	1	4

Postcode	Terminal	Zone in	Zone out
8971	8910	1	4
8972	8910	1	4
8973	8910	1	4
8974	8910	1	4
8975	8910	1	4
8976	8910	1	5
8977	8910	1	4
8978	8910	1	4
8979	8910	1	4
8980	8910	1	5
8981	8910	1	5
8982	8910	1	5
8983	8910	1	5
8984	8910	1	5
8985	8910	1	5
8986	8910	1	5
8987	8910	1	5
8988	8910	1	5
8989	8910	1	5
8990	8910	1	5
8991	8910	1	5
8992	8910	1	5
8993	8910	1	5
8994	8910	1	5
8995	8910	1	5
8996	8910	1	5

Postcode	Terminal	Zone in	Zone out
8997	8910	1	5
8998	8910	1	5
8999	8910	1	5
9000	9000	0	3
9001	9000	0	3
9002	9000	0	3
9003	9000	0	3
9004	9000	0	3
9005	9000	0	3
9006	9000	0	3
9007	9000	0	3
9008	9000	0	3
9009	9000	0	3
9010	9000	0	3
9011	9000	0	3
9012	9000	0	3
9013	9000	0	3
9014	9000	0	3
9015	9000	0	3
9016	9000	0	3
9017	9000	0	3
9018	9000	0	3
9019	9000	0	3
9020	9000	0	4
9021	9000	0	4
9022	9000	1	4

Postcode	Terminal	Zone in	Zone out
9023	9000	1	5
9024	9000	0	3
9025	9000	0	3
9026	9000	1	5
9027	9000	1	5
9028	9000	1	5
9029	9000	0	3
9030	9000	1	5
9031	9000	1	5
9032	9000	1	5
9033	9000	1	5
9034	9000	1	5
9035	9000	1	5
9036	9000	1	5
9037	9000	0	3
9038	9000	0	3
9039	9000	0	3
9040	9000	1	5
9041	9000	1	4
9042	9000	1	5
9043	9000	1	5
9044	9000	1	5
9045	9000	1	5
9046	9000	1	5
9047	9000	1	5
9048	9000	1	5

Postcode	Terminal	Zone in	Zone out
9049	9000	1	4
9050	9000	1	5
9051	9000	1	5
9052	9000	1	5
9053	9000	1	5
9054	9000	1	5
9055	9000	1	5
9056	9000	1	5
9057	9000	1	5
9058	9000	1	5
9059	9000	1	5
9060	9000	1	5
9061	9000	1	5
9062	9000	1	5
9063	9000	1	5
9064	9000	1	5
9065	9000	1	5
9066	9000	1	5
9067	9000	1	5
9068	9000	1	5
9069	9000	1	5
9070	9000	1	5
9071	9000	1	5
9072	9000	1	5
9073	9000	1	5
9074	9000	1	5

Postcode	Terminal	Zone in	Zone out
9075	9000	1	5
9076	9000	1	5
9077	9000	1	5
9078	9000	1	5
9079	9000	1	5
9080	9000	1	5
9081	9000	1	5
9082	9000	1	5
9083	9000	1	5
9084	9000	1	5
9085	9000	1	5
9086	9000	1	5
9087	9000	1	5
9088	9000	1	5
9089	9000	1	5
9090	9000	1	5
9091	9000	1	5
9092	9000	1	5
9093	9000	1	5
9094	9000	1	5
9095	9000	1	5
9096	9000	1	5
9097	9000	1	5
9098	9000	1	5
9099	9000	1	5
9100	9000	1	4

Postcode	Terminal	Zone in	Zone out
9101	9000	1	4
9102	9000	1	4
9103	9000	1	5
9104	9000	1	4
9105	9000	1	4
9106	9000	1	5
9107	9000	1	5
9108	9000	1	5
9109	9000	1	5
9110	9000	1	5
9111	9000	1	5
9112	9000	1	5
9113	9000	1	5
9114	9000	1	5
9115	9000	1	5
9116	9000	1	5
9117	9000	1	5
9118	9000	1	5
9119	9000	1	5
9120	9000	1	5
9121	9000	1	5
9122	9000	1	5
9123	9000	1	5
9124	9000	1	5
9125	9000	1	5
9126	9000	1	5

Postcode	Terminal	Zone in	Zone out
9127	9000	1	5
9128	9000	1	5
9129	9000	1	5
9130	9000	1	5
9131	9000	1	5
9132	9000	1	5
9133	9000	1	5
9134	9000	1	5
9135	9000	1	5
9136	9000	1	5
9137	9000	1	5
9138	9000	1	5
9139	9000	1	5
9140	9000	1	5
9141	9000	1	5
9142	9000	1	5
9143	9000	1	5
9144	9000	1	5
9145	9000	1	5
9146	9000	1	5
9147	9000	1	5
9148	9000	1	5
9149	9000	1	5
9150	9000	1	5
9151	9000	1	5
9152	9000	1	5

Postcode	Terminal	Zone in	Zone out
9153	9000	1	5
9154	9000	1	5
9155	9000	1	5
9156	9000	1	5
9157	9000	1	5
9158	9000	1	5
9159	9000	1	5
9160	9000	1	5
9161	9510	1	5
9162	9510	1	5
9163	9510	1	5
9164	9510	1	5
9165	9510	1	5
9166	9510	1	5
9167	9510	1	5
9168	9510	1	5
9169	9510	1	5
9170	9000	1	5
9171	9000	1	5
9172	9000	1	5
9173	9000	1	5
9174	9000	1	5
9175	9000	1	5
9176	9000	1	5
9177	9000	1	5
9178	9000	1	5

Postcode	Terminal	Zone in	Zone out
9179	9000	1	5
9180	9000	1	5
9181	9000	1	5
9182	9000	1	5
9183	9000	1	5
9184	9000	1	5
9185	9000	1	5
9186	9000	1	5
9187	9510	1	5
9188	9510	1	5
9189	9000	1	5
9190	9000	1	5
9191	9000	1	5
9192	9000	1	5
9193	9000	1	5
9194	9000	1	5
9195	9000	1	5
9196	9000	1	5
9197	9000	1	5
9198	9000	1	5
9199	9000	1	5
9200	9000	1	5
9201	9000	1	5
9202	9000	1	5
9203	9000	1	5
9204	9000	1	5

Postcode	Terminal	Zone in	Zone out
9205	9000	1	5
9206	9000	1	5
9207	9000	1	5
9208	9000	1	5
9209	9000	1	5
9210	9000	1	5
9211	9000	1	5
9212	9000	1	5
9213	9000	1	5
9214	9000	1	5
9215	9000	1	5
9216	9000	1	5
9217	9000	1	5
9218	9000	1	5
9219	9000	1	5
9220	9000	1	5
9221	9000	1	5
9222	9000	1	5
9223	9000	1	5
9224	9000	1	5
9225	9000	1	5
9226	9000	1	5
9227	9000	1	5
9228	9000	1	5
9229	9000	1	5
9230	9000	1	5

Postcode	Terminal	Zone in	Zone out
9231	9000	1	5
9232	9000	1	5
9233	9000	1	5
9234	9000	1	5
9235	9000	1	5
9236	9000	1	5
9237	9000	1	5
9238	9000	1	5
9239	9000	1	5
9240	9000	0	3
9241	9000	0	3
9242	9000	0	3
9243	9000	0	3
9244	9000	0	3
9245	9000	0	3
9246	9000	0	3
9247	9000	0	3
9248	9000	0	3
9249	9000	0	3
9250	9000	0	3
9251	9000	0	3
9252	9000	0	3
9253	9000	0	3
9254	9000	0	3
9255	9000	0	3
9256	9000	0	3

Postcode	Terminal	Zone in	Zone out
9257	9000	0	3
9258	9000	0	3
9259	9000	0	3
9260	9000	0	3
9261	9000	0	3
9262	9000	0	3
9263	9000	0	3
9264	9000	0	3
9265	9000	0	3
9266	9000	0	3
9267	9000	0	3
9268	9000	0	3
9269	9000	0	3
9270	9000	0	3
9271	9000	0	3
9272	9000	0	3
9273	9000	0	3
9274	9000	0	3
9275	9000	0	3
9276	9000	0	3
9277	9000	0	3
9278	9000	0	3
9279	9000	0	3
9280	9000	0	3
9281	9000	0	3
9282	9000	0	3

Postcode	Terminal	Zone in	Zone out
9283	9000	0	3
9284	9000	0	3
9285	9000	0	3
9286	9000	0	3
9287	9000	0	3
9288	9000	0	3
9289	9000	0	3
9290	9000	0	3
9291	9000	0	3
9292	9000	0	3
9293	9000	0	3
9294	9000	0	3
9295	9000	0	3
9296	9000	0	3
9297	9000	0	3
9298	9000	0	3
9299	9000	0	3
9300	8510	1	5
9301	8510	1	5
9302	8510	1	5
9303	8510	1	5
9304	8510	1	5
9305	8510	1	5
9306	8510	1	5
9307	8510	1	5
9308	8510	1	5

Postcode	Terminal	Zone in	Zone out
9309	8510	1	5
9310	8510	1	5
9311	8510	1	5
9312	8510	1	5
9313	8510	1	5
9314	8510	1	5
9315	8510	1	5
9316	8510	1	5
9317	8510	1	5
9318	8510	1	5
9319	8510	1	5
9320	8510	1	5
9321	8510	1	5
9322	8510	1	5
9323	8510	1	5
9324	8510	1	5
9325	8510	1	5
9326	8510	1	5
9327	8510	1	5
9328	8510	1	5
9329	8510	1	5
9330	8510	1	5
9331	8510	1	5
9332	8510	1	5
9333	8510	1	5
9334	8510	1	5

Postcode	Terminal	Zone in	Zone out
9335	8510	1	5
9336	8510	1	5
9337	8510	1	5
9338	8510	1	5
9339	8510	1	5
9340	8510	1	5
9341	8510	1	5
9342	8510	1	5
9343	8510	1	5
9344	8510	1	5
9345	8510	1	5
9346	8510	1	5
9347	8510	1	5
9348	8510	1	5
9349	8510	1	5
9350	8510	1	5
9351	8510	1	5
9352	8510	1	5
9353	8510	1	5
9354	8510	1	5
9355	8510	1	5
9356	8510	1	5
9357	8510	1	5
9358	8510	1	5
9359	8510	1	5
9360	8510	1	5

Postcode	Terminal	Zone in	Zone out
9361	8510	1	5
9362	8510	1	5
9363	8510	1	5
9364	8510	1	5
9365	8510	1	5
9366	8510	1	5
9367	8510	1	5
9368	8510	1	5
9369	8510	1	5
9370	8510	1	5
9371	8510	1	5
9372	8510	1	5
9373	8510	1	5
9374	8510	1	5
9375	8510	1	5
9376	8510	1	5
9377	8510	1	5
9378	8510	1	5
9379	8510	1	5
9380	8510	1	5
9381	8510	1	5
9382	8510	1	5
9383	8510	1	5
9384	8510	1	5
9385	8510	1	5
9386	8510	1	5

Postcode	Terminal	Zone in	Zone out
9387	8510	1	5
9388	8510	1	5
9389	8510	1	5
9390	8510	1	5
9391	8510	1	5
9392	8510	1	5
9393	8510	1	5
9394	8510	1	5
9395	8510	1	5
9396	8510	1	5
9397	8510	1	5
9398	8510	1	5
9399	8510	1	5
9400	9400	0	3
9401	9400	0	3
9402	9400	0	5
9403	9400	0	3
9404	9400	0	3
9405	9400	0	3
9406	9400	0	3
9407	9400	0	3
9408	9400	0	3
9409	9400	0	3
9410	9400	0	3
9411	9400	0	3
9412	9400	0	3

Postcode	Terminal	Zone in	Zone out
9413	9400	0	3
9414	9400	0	3
9415	9400	0	4
9416	9400	0	3
9417	9400	0	3
9418	9400	1	4
9419	9400	1	4
9420	9400	1	5
9421	9400	1	5
9422	9400	1	5
9423	9400	1	5
9424	9400	1	5
9425	9400	1	5
9426	9400	1	5
9427	9400	1	5
9428	9400	1	5
9429	9400	1	5
9430	8510	1	5
9431	9400	1	5
9432	9400	1	5
9433	9400	1	5
9434	9400	1	5
9435	9400	1	5
9436	8510	1	5
9437	9400	1	5
9438	9400	1	5

Postcode	Terminal	Zone in	Zone out
9439	8510	1	5
9440	8510	1	5
9441	8510	1	5
9442	8510	1	5
9443	8510	1	5
9444	8510	1	5
9445	8510	1	5
9446	8510	1	5
9447	8510	1	5
9448	8510	1	5
9449	8510	1	5
9450	8510	1	5
9451	8510	1	5
9452	8510	1	5
9453	8510	1	5
9454	8510	1	5
9455	8510	1	5
9456	8510	1	5
9457	9400	1	5
9458	9400	1	5
9459	9400	1	5
9460	9400	1	5
9461	9400	1	5
9462	9400	1	5
9463	9400	1	5
9464	9400	1	5

Postcode	Terminal	Zone in	Zone out
9465	9400	1	5
9466	9400	1	5
9467	9400	1	5
9468	9400	1	5
9469	9400	1	5
9470	8510	1	5
9471	8510	1	5
9472	9400	1	5
9473	9400	1	5
9474	9400	1	5
9475	9400	1	5
9476	9400	1	5
9477	9400	1	5
9478	9400	0	3
9479	9400	0	3
9480	9400	0	3
9481	9400	0	3
9482	9400	0	3
9483	9400	0	3
9484	9400	0	3
9485	9400	0	3
9486	9400	0	3
9487	9400	0	3
9488	9400	0	3
9489	9400	0	3
9490	9400	0	3

Postcode	Terminal	Zone in	Zone out
9491	9400	0	3
9492	9400	0	3
9493	9400	0	3
9494	9400	0	3
9495	9400	0	3
9496	9400	0	3
9497	9400	0	3
9498	9400	0	3
9499	9400	0	3
9500	9510	0	3
9501	9510	0	3
9502	9510	0	3
9503	9510	0	3
9504	9510	0	3
9505	9510	0	3
9506	9510	0	3
9507	9510	0	3
9508	9510	0	3
9509	9510	0	3
9510	9510	0	3
9511	9510	0	3
9512	9510	0	3
9513	9510	0	3
9514	9510	0	3
9515	9510	0	3
9516	9510	0	4

Postcode	Terminal	Zone in	Zone out
9517	9510	0	5
9518	9510	0	5
9519	9510	1	5
9520	9510	1	5
9521	9510	1	5
9522	9510	1	5
9523	9510	1	5
9524	9510	1	5
9525	9510	1	5
9526	9510	1	5
9527	9510	1	5
9528	9510	1	5
9529	9510	1	5
9530	9510	1	5
9531	9510	1	5
9532	9510	1	5
9533	9510	1	5
9534	9510	1	5
9535	9510	1	5
9536	9510	1	5
9537	9510	1	5
9538	9510	1	5
9539	9510	1	5
9540	9510	1	5
9541	9510	1	5
9542	9510	1	5

Postcode	Terminal	Zone in	Zone out
9543	9510	1	5
9544	9510	1	5
9545	9510	1	5
9546	9510	1	5
9547	9510	1	5
9548	9510	1	5
9549	9510	1	5
9550	9510	1	5
9551	9510	1	5
9552	9510	1	5
9553	9510	1	5
9554	9510	1	5
9555	9510	1	5
9556	9510	1	5
9557	9510	1	5
9558	9510	1	5
9559	9510	1	5
9560	9510	1	5
9561	9510	1	5
9562	9510	1	5
9563	9510	1	5
9564	9510	1	5
9565	9510	1	5
9566	9510	1	5
9567	9510	1	5
9568	9510	1	5

Postcode	Terminal	Zone in	Zone out
9569	9510	1	5
9570	9510	1	5
9571	9510	1	5
9572	9510	1	5
9573	9510	1	5
9574	9510	1	5
9575	9510	1	5
9576	9510	1	5
9577	9510	1	5
9578	9510	1	5
9579	9510	1	5
9580	9510	1	5
9581	9510	1	5
9582	9510	1	5
9583	9510	1	5
9584	9510	1	5
9585	9510	1	5
9586	9510	1	5
9587	9510	1	5
9588	9510	1	5
9589	9510	1	5
9590	9510	1	5
9591	9510	1	5
9592	9510	1	5
9593	9510	1	5
9594	9510	1	5

Postcode	Terminal	Zone in	Zone out
9595	9510	1	5
9596	9510	1	5
9597	9510	1	5
9598	9510	1	5
9599	9510	1	5
9600	9510	0	4
9601	9510	1	5
9602	9510	1	5
9603	9510	1	5
9604	9510	1	5
9605	9510	1	5
9606	9510	1	5
9607	9510	1	5
9608	9510	1	5
9609	9510	1	5
9610	9510	0	4
9611	9510	0	3
9612	9510	1	5
9613	9510	1	5
9614	9510	1	5
9615	9510	0	3
9616	9510	0	3
9617	9510	0	3
9618	9510	0	3
9619	9510	0	3
9620	9510	1	5

Postcode	Terminal	Zone in	Zone out
9621	9510	1	4
9622	9510	1	4
9623	9510	1	4
9624	9510	1	5
9625	9510	1	5
9626	9510	1	5
9627	9510	1	5
9628	9510	1	5
9629	9510	1	5
9630	9510	1	5
9631	9510	1	5
9632	9510	1	5
9633	9510	1	5
9634	9510	1	5
9635	9510	1	5
9636	9510	1	5
9637	9510	1	5
9638	9510	1	5
9639	9510	1	5
9640	9510	1	5
9641	9510	1	5
9642	9510	1	5
9643	9510	1	5
9644	9510	1	5
9645	9510	1	5
9646	9510	1	5

Postcode	Terminal	Zone in	Zone out
9647	9510	1	5
9648	9510	1	5
9649	9510	1	5
9650	9510	1	5
9651	9510	1	5
9652	9510	1	5
9653	9510	1	5
9654	9510	1	5
9655	9510	1	5
9656	9510	1	5
9657	9510	1	5
9658	9510	1	5
9659	9510	1	5
9660	9510	1	5
9661	9510	1	5
9662	9510	1	5
9663	9510	1	5
9664	9510	1	5
9665	9510	1	5
9666	9510	1	5
9667	9510	1	5
9668	9510	1	5
9669	9510	1	5
9670	9510	1	5
9671	9510	1	5
9672	9510	1	5

Postcode	Terminal	Zone in	Zone out
9673	9510	1	5
9674	9510	1	5
9675	9510	1	5
9676	9510	1	5
9677	9510	1	5
9678	9510	1	5
9679	9510	1	5
9680	9510	1	5
9681	9510	1	5
9682	9510	1	5
9683	9510	1	5
9684	9510	1	5
9685	9510	1	5
9686	9510	1	5
9687	9510	1	5
9688	9510	1	5
9689	9510	1	5
9690	9510	1	5
9691	9510	1	5
9692	9510	1	5
9693	9510	1	5
9694	9510	1	5
9695	9510	1	5
9696	9510	1	5
9697	9510	1	5
9698	9510	1	5

Postcode	Terminal	Zone in	Zone out
9699	9510	1	5
9700	9510	1	5
9701	9510	1	5
9702	9510	1	5
9703	9510	1	5
9704	9510	1	5
9705	9510	1	5
9706	9510	1	5
9707	9510	1	5
9708	9510	1	5
9709	9510	1	5
9710	9510	1	5
9711	9510	1	5
9712	9510	1	5
9713	9510	1	5
9714	9510	1	5
9715	9510	1	5
9716	9510	1	5
9717	9510	1	5
9718	9510	1	5
9719	9510	1	5
9720	9510	1	5
9721	9510	1	5
9722	9510	1	5
9723	9510	1	5
9724	9510	1	5

Postcode	Terminal	Zone in	Zone out
9725	9510	1	5
9726	9510	1	5
9727	9510	1	5
9728	9510	1	5
9729	9510	1	5
9730	9510	1	5
9731	9510	1	5
9732	9510	1	5
9733	9510	1	5
9734	9510	1	5
9735	9510	1	5
9736	9510	1	5
9737	9510	1	5
9738	9510	1	5
9739	9510	1	5
9740	9846	1	5
9741	9846	1	5
9742	9510	1	5
9743	9510	1	5
9744	9510	1	5
9745	9510	1	5
9746	9510	1	5
9747	9510	1	5
9748	9510	1	5
9749	9510	1	5
9750	9510	1	5

Postcode	Terminal	Zone in	Zone out
9751	9510	1	5
9752	9510	1	5
9753	9510	1	5
9754	9510	1	5
9755	9510	1	5
9756	9510	1	5
9757	9510	1	5
9758	9510	1	5
9759	9510	1	5
9760	9510	1	5
9761	9510	1	5
9762	9510	1	5
9763	9510	1	5
9764	9510	1	5
9765	9510	1	5
9766	9510	1	5
9767	9510	1	5
9768	9510	1	5
9769	9510	1	5
9770	9846	1	5
9771	9846	1	5
9772	9846	1	5
9773	9846	1	5
9774	9846	1	5
9775	9846	1	5
9776	9846	1	5

Postcode	Terminal	Zone in	Zone out
9777	9846	1	5
9778	9846	1	5
9779	9846	1	5
9780	9846	1	5
9781	9846	1	5
9782	9846	1	5
9783	9846	1	5
9784	9846	1	5
9785	9846	1	5
9786	9846	1	5
9787	9846	1	5
9788	9846	1	5
9789	9846	1	5
9790	9846	1	5
9791	9846	1	5
9792	9846	1	5
9793	9846	1	5
9794	9846	1	5
9795	9846	1	5
9796	9846	1	5
9797	9846	1	5
9798	9846	1	5
9799	9846	1	5
9800	9846	1	5
9801	9846	1	5
9802	9846	1	5

Postcode	Terminal	Zone in	Zone out
9803	9846	1	5
9804	9846	1	5
9805	9846	1	5
9806	9846	1	5
9807	9846	1	5
9808	9846	1	5
9809	9846	1	5
9810	9846	1	5
9811	9846	1	5
9812	9846	1	5
9813	9846	1	5
9814	9846	1	5
9815	9846	1	5
9816	9846	1	5
9817	9846	1	5
9818	9846	1	5
9819	9846	1	5
9820	9846	1	5
9821	9846	1	5
9822	9846	1	5
9823	9846	1	5
9824	9846	1	5
9825	9846	1	5
9826	9846	1	5
9827	9846	1	5
9828	9846	1	5

Postcode	Terminal	Zone in	Zone out
9829	9846	1	5
9830	9846	1	5
9831	9846	1	5
9832	9846	1	5
9833	9846	1	5
9834	9846	1	5
9835	9846	1	5
9836	9846	1	5
9837	9846	1	5
9838	9846	1	5
9839	9846	1	5
9840	9846	1	5
9841	9846	1	5
9842	9846	1	5
9843	9846	1	5
9844	9846	0	3
9845	9846	0	5
9846	9846	0	3
9847	9846	0	3
9848	9846	0	3
9849	9846	0	3
9850	9846	0	3
9851	9846	0	3
9852	9846	0	3
9853	9846	0	3
9854	9846	0	3

Postcode	Terminal	Zone in	Zone out
9855	9846	0	3
9856	9846	0	3
9857	9846	0	3
9858	9846	0	3
9859	9846	0	3
9860	9846	0	3
9861	9846	0	3
9862	9846	0	3
9863	9846	0	3
9864	9846	0	3
9865	9846	0	3
9866	9846	0	3
9867	9846	0	3
9868	9846	0	3
9869	9846	0	3
9870	9846	0	3
9871	9846	0	3
9872	9846	0	3
9873	9846	0	3
9874	9846	0	3
9875	9846	0	3
9876	9846	0	3
9877	9846	0	3
9878	9846	0	3
9879	9846	0	3
9880	9846	0	3

Postcode	Terminal	Zone in	Zone out
9881	9846	0	3
9882	9846	0	3
9883	9846	0	3
9884	9846	0	3
9885	9846	0	3
9886	9846	0	3
9887	9846	0	3
9888	9846	0	3
9889	9846	0	3
9890	9846	0	3
9891	9846	0	3
9892	9846	0	3
9893	9846	0	3
9894	9846	0	3
9895	9846	0	3
9896	9846	0	3
9897	9846	0	3
9898	9846	0	3
9899	9846	0	3
9900	9846	0	4
9901	9846	0	3
9902	9846	0	3
9903	9846	0	3
9904	9846	0	3
9905	9846	0	3
9906	9846	0	3

Postcode	Terminal	Zone in	Zone out
9907	9846	0	3
9908	9846	0	3
9909	9846	0	3
9910	9846	0	4
9911	9846	0	3
9912	9846	0	4
9913	9846	0	3
9914	9846	0	3
9915	9846	0	3
9916	9846	0	3
9917	9846	0	3
9918	9846	0	3
9919	9846	0	3
9920	9846	1	5
9921	9846	1	5
9922	9846	1	5
9923	9846	1	5
9924	9846	1	5
9925	9846	1	5
9926	9846	1	5
9927	9846	1	5
9928	9846	1	5
9929	9846	1	5
9930	9846	1	5
9931	9846	1	5
9932	9846	1	5

Postcode	Terminal	Zone in	Zone out
9933	9846	1	5
9934	9846	1	5
9935	9846	1	5
9936	9846	1	5
9937	9846	1	5
9938	9846	1	5
9939	9846	1	5
9940	9846	1	5
9941	9846	1	5
9942	9846	1	5
9943	9846	1	5
9944	9846	1	5
9945	9846	1	5
9946	9846	1	5
9947	9846	1	5
9948	9846	1	5
9949	9846	1	5
9950	9846	1	5
9951	9846	1	5
9952	9846	1	5
9953	9846	1	5
9954	9846	1	5
9955	9846	1	5
9956	9846	1	5
9957	9846	1	5
9958	9846	1	5

Postcode	Terminal	Zone in	Zone out
9959	9846	1	5
9960	9846	1	5
9961	9846	1	5
9962	9846	1	5
9963	9846	1	5
9964	9846	1	5
9965	9846	1	5
9966	9846	1	5
9967	9846	1	5
9968	9846	1	5
9969	9846	1	5
9970	9846	1	5
9971	9846	1	5
9972	9846	1	5
9973	9846	1	5
9974	9846	1	5
9975	9846	1	5
9976	9846	1	5
9977	9846	1	5
9978	9846	1	5
9979	9846	1	5
9980	9846	1	5
9981	9846	1	5
9982	9846	1	5
9983	9846	1	5
9984	9846	1	5

Postcode	Terminal	Zone in	Zone out
9985	9846	1	5
9986	9846	1	5
9987	9846	1	5
9988	9846	1	5
9989	9846	1	5
9990	9846	1	5
9991	9846	1	5
9992	9846	1	5
9993	9846	1	5
9994	9846	1	5
9995	9846	1	5
9996	9846	1	5
9997	9846	1	5
9998	9846	1	5
9999	9846	1	5

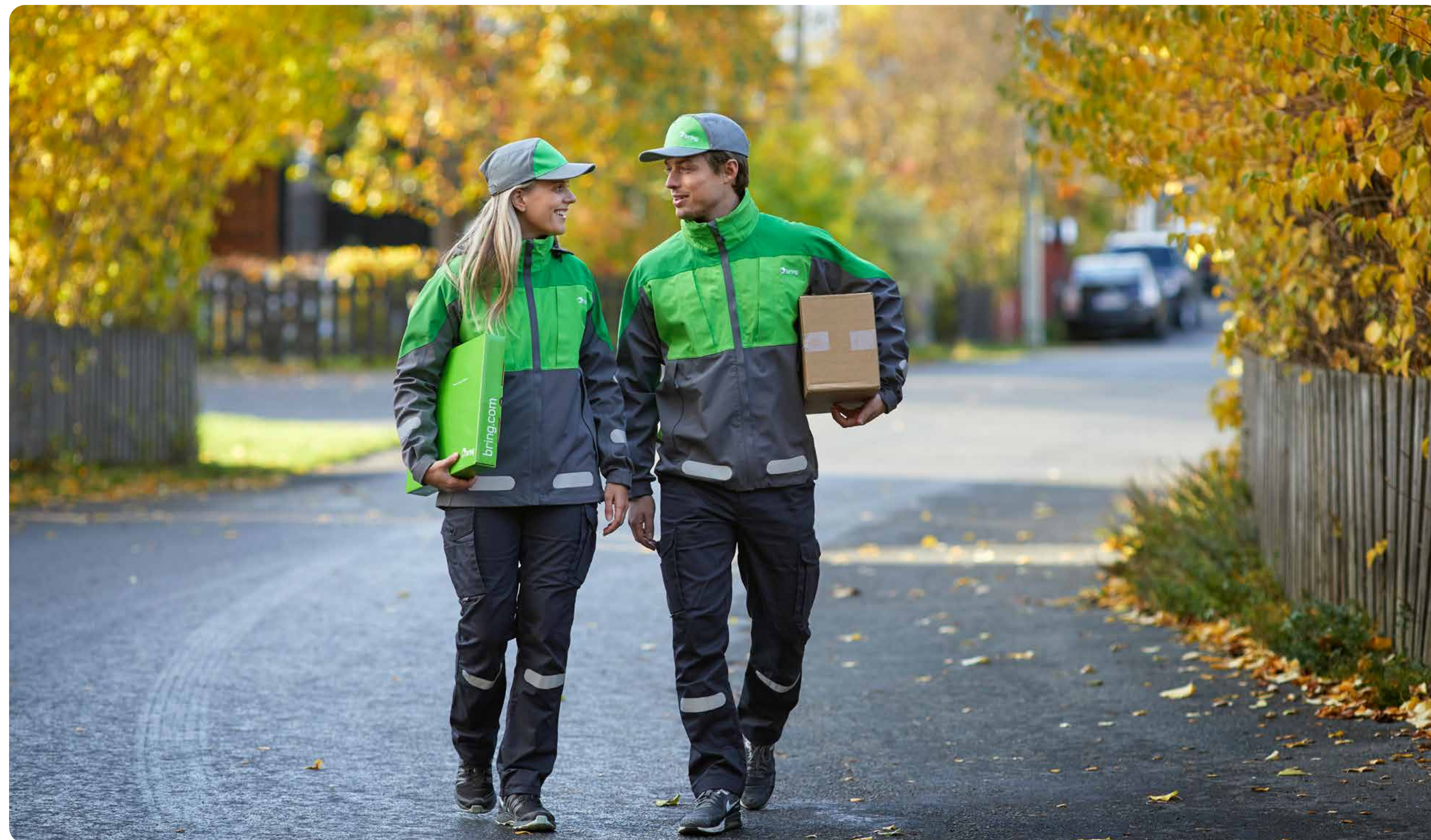

3.4.1 Pick-up parcel

Weight in kg (up to)	Zone 1	Zone 2	Zone 3	Zone 4	Zone 5	Zone 6	Zone 7	Zone 8
1	136	149	163	179	191	205	217	235
2	139	154	166	183	196	210	222	238
3	141	158	173	186	199	214	229	242
5	151	167	184	197	211	224	239	252
7	168	191	205	217	235	246	259	275
10	182	205	217	235	246	259	275	288
15	239	264	282	295	305	321	339	350
20	305	336	359	388	411	438	464	491
25	351	390	423	461	499	537	572	609
30	393	438	487	535	583	632	676	723
35	425	484	541	596	655	712	767	825
40	458	523	588	649	715	781	845	909
50	520	598	679	759	839	917	998	1078
60	581	675	770	866	960	1058	1154	1250
70	641	753	863	972	1086	1197	1307	1418
80	703	830	956	1084	1208	1336	1460	1587
90	765	906	1048	1187	1333	1472	1612	1758
100	826	985	1140	1299	1454	1610	1768	1925



Maximum actual weight: 35 kg Maximum length: 240 cm Maximum length plus circumference: 360 cm

Surcharge Pick-up parcel

For pick-up parcels posted at post offices/business centres/Post in Shops and for Return services delivered to post offices/business centres/Post in Shops the price is NOK 25 higher.

Letter notification NOK 23. Elective pick-up point NOK 0.

See also bring.no.

3.4.2 Home delivery parcel plus/Return Pick up parcel

Weight in kg (up to)	Zone 1	Zone 2	Zone 3	Zone 4	Zone 5	Zone 6	Zone 7	Zone 8
1	175	201	223	243	253	281	303	319
2	182	207	228	248	261	289	314	327
3	185	214	243	259	270	301	327	333
5	202	226	257	277	289	322	348	361
7	220	248	276	292	311	338	365	378
10	256	283	311	329	345	374	397	414
15	290	322	350	374	387	417	443	481
20	329	363	393	420	439	471	504	551
25	357	397	436	467	488	530	563	613
30	389	436	477	515	545	590	630	682
35	420	470	523	567	603	651	698	758
40	451	510	571	616	660	715	767	819
50	505	578	648	712	761	829	891	996
60	565	651	737	811	875	955	1026	1144
70	627	729	828	913	988	1079	1161	1274
80	685	802	913	1013	1100	1198	1291	1403
90	745	873	996	1109	1207	1319	1422	1528
100	803	944	1083	1205	1315	1436	1549	1651



Maximum actual weight: 35 kg Maximum length: 240 cm Maximum length plus circumference: 360 cm.
 Minimum price per parcel: NOK 105.

Surcharge Home delivery parcel plus
 Second delivery attempt NOK 65 per package.

3.4.3 Business parcel express/Return Express

Freight-chargeable weight up to and including (kg)	Zone 1	Zone 2	Zone 3	Zone 4	Zone 5	Zone 6	Zone 7	Zone 8	Freight-chargeable weight up to and including (kg)	Zone 1	Zone 2	Zone 3	Zone 4	Zone 5	Zone 6	Zone 7	Zone 8
1	454	480	515	549	713	991	1205	1205	19	833	933	969	1136	1664	2258	3248	3248
2	470	504	538	582	765	1055	1310	1310	20	857	960	995	1165	1719	2330	3369	3369
3	489	529	560	616	813	1122	1414	1414	21	876	985	1017	1200	1778	2402	3492	3492
4	511	553	587	645	861	1191	1520	1520	22	900	1012	1044	1231	1833	2476	3613	3613
5	532	577	609	680	908	1259	1627	1627	23	923	1035	1071	1264	1892	2549	3737	3737
6	548	603	634	711	956	1326	1733	1733	24	945	1063	1097	1297	1949	2620	3856	3856
7	568	625	660	744	1007	1394	1839	1839	25	970	1087	1123	1326	2004	2696	3976	3976
8	590	651	683	773	1055	1465	1941	1941	26	994	1114	1150	1360	2062	2768	4098	4098
9	608	677	707	809	1104	1533	2048	2048	27	1014	1140	1172	1391	2117	2842	4221	4221
10	626	699	734	840	1157	1602	2157	2157	28	1035	1165	1201	1425	2175	2913	4343	4343
11	646	725	761	874	1210	1674	2276	2276	29	1061	1191	1227	1458	2230	2988	4465	4465
12	672	750	787	907	1268	1745	2396	2396	30	1082	1216	1250	1491	2290	3061	4587	4587
13	695	773	812	941	1323	1821	2516	2516	31	1102	1243	1279	1522	2345	3133	4707	4707
14	719	803	837	973	1379	1894	2640	2640	32	1127	1271	1304	1556	2401	3206	4831	4831
15	742	831	865	1004	1438	1966	2761	2761	33	1150	1297	1332	1587	2458	3279	4949	4949
16	765	857	889	1035	1494	2040	2883	2883	34	1170	1322	1357	1623	2514	3350	5072	5072
17	788	879	914	1070	1552	2112	3006	3006	35	1195	1348	1384	1654	2572	3424	5195	5195
18	809	907	942	1101	1607	2183	3129	3129	Unit after 35 kg	22	24	26	34	53	72	109	109

The price excludes toll charges and fuel surcharges. Maximum actual weight: 35 kg. Maximum length: 240 cm. Maximum length plus circumference: 360 cm.

Surcharge Business parcel express:

Delivery on Saturday is NOK 283 per package to a recipient in the central area and NOK 751 to a recipient in the non-central area.

Optional pick-up point NOK 47.

3.4.4 Business parcel/Return Business parcel

Weight in kg (up to)	Zone 1	Zone 2	Zone 3	Zone 4	Zone 5	Zone 6	Zone 7	Zone 8	Weight in kg (up to)	Zone 1	Zone 2	Zone 3	Zone 4	Zone 5	Zone 6	Zone 7	Zone 8
1	205	235	256	275	295	315	333	350	110	961	1127	1289	1438	1578	1715	1844	1947
2	215	240	260	283	307	326	347	359	120	1022	1204	1377	1536	1693	1840	1977	2080
3	220	246	271	295	317	339	359	367	130	1084	1279	1464	1640	1807	1967	2112	2206
5	238	262	290	315	338	361	384	398	140	1144	1352	1551	1736	1916	2083	2243	2335
7	258	284	310	334	359	377	402	413	150	1204	1422	1632	1832	2022	2200	2370	2453
10	295	322	349	370	398	417	438	457	160	1259	1493	1717	1930	2126	2316	2493	2577
15	335	365	395	419	443	465	488	529	170	1318	1565	1797	2023	2231	2433	2619	2695
20	376	411	441	470	500	524	553	606	180	1372	1629	1880	2113	2335	2542	2736	2807
25	409	451	488	522	556	590	619	674	190	1424	1700	1958	2202	2434	2654	2857	2923
30	443	492	534	574	617	658	691	751	200	1480	1764	2035	2291	2528	2758	2970	3033
35	474	529	583	633	681	724	768	832	225	1621	1939	2240	2523	2786	3041	3279	3523
40	508	571	633	689	744	793	844	901	250	1770	2119	2449	2764	3057	3334	3594	3838
50	568	646	721	792	858	920	980	1095	275	1916	2294	2656	2996	3319	3620	3906	4136
60	638	729	818	902	981	1057	1128	1258	300	2056	2467	2859	3229	3574	3903	4206	4427
70	703	813	919	1014	1104	1195	1276	1399	350	2312	2780	3226	3645	4040	4412	4758	4973
80	771	894	1012	1124	1228	1326	1422	1541	400	2595	3048	3544	4006	4441	4851	5235	5502
90	833	971	1103	1230	1347	1458	1565	1679	500	3155	3592	4182	4724	5241	5727	6182	6562
100	898	1052	1196	1334	1464	1587	1706	1814	Unit per 100 kg	565	588	640	721	803	879	951	1165

The price excludes toll charges and fuel surcharges. Maximum actual weight: 35 kg. Maximum length: 240 cm. Maximum length plus circumference: 360 cm.

Surcharge for Business parcel:

The second delivery attempt is NOK 58 per package. Delivery to post office/Post in Shops NOK 57 per package.

The price for Business parcels posted at a post office/Post in Shops is NOK 25 higher.

See also bring.no.

3.4.5 Additional services for parcels

Surcharges	Business parcel	Business parcel express	Pick-up parcel	Home delivery parcel plus
Pick-up, simple assignment	410	410	410	410
Cash on Delivery			85	
Stop claim/delete cash on delivery	217	217	217	217
Proof of identity required	17	17	17	17
Personal delivery		23	23	23
Svalbard surcharge*	338	338	338	338
Work by agreement	1219	1219	1219	1219
Driver calls	30	30	30	30

* Since Svalbard and Spitsbergen are considered to be a third country in customs duty terms, correct documentation is required as commercial or pro forma invoices. For parcels with a net goods value exceeding NOK 5,000, customs duty of NOK 240 and NOK 30 per product line will be applied.

3.4.6 Surcharge for parcels

Surcharges	Business parcel	Business parcel express	Pick-up parcel	Home delivery parcel plus
NEW: Delayed EDI	64	64	64	64
Produce EDI	157	157	157	157
Handling surcharge	157	157	157	157
Manual invoice	338	338	338	338
Wrong customer number	1010	1010	1010	1010
Incorrect consignment number	64	64	64	64
Transport label/ barcode error	77	77	77	77
Incorrect address	250	250	250	250
Small pick- up *	250	250	250	250

* Applies only if the total turnover value for Pick up parcel, Home delivery parcel plus, and Business parcel is below NOK 450/day. Does not apply to Parcel in mailbox.



3.5.1 Partloads – freight in NOK per 1,000 kg

Zone	Minimum price	Price per tonne					
		3500-4999	5000-6999	7000-8999	9000-11999	12000-14999	15000-99999
0	5469	1500	1374	1330	1304	1277	1277
1	5469	1500	1374	1330	1304	1277	1277
2	6839	1874	1526	1480	1448	1418	1418
3	8382	2295	1920	1864	1824	1790	1790
4	10571	2898	2674	2592	2539	2489	2489
5	11396	3122	2874	2786	2734	2674	2674
6	12223	3347	3075	2983	2921	2859	2859
7	13310	3645	3347	3251	3183	3116	3116
8	15046	4125	3773	3659	3588	3506	3506
9	16235	4448	4095	3975	3893	3812	3812
10	17509	4798	4374	4241	4154	4068	4068
11	18416	5046	4619	4480	4388	4297	4297
12	19957	5468	5018	4872	4770	4669	4669
13	21519	5895	5395	5233	5124	5016	5016
14	23154	6345	5819	5646	5530	5412	5412
15	24535	6721	6170	5986	5863	5736	5736
16	26159	7168	6568	6368	6242	6110	6110
17	27709	7593	6996	6786	6647	6506	6506
18	29354	8043	7367	7148	7001	6851	6851
19	30995	8492	7793	7556	7401	7245	7245
20	32545	8917	8165	7925	7759	7596	7596



3.5.2 Price list for Business groupage

Minimum price NOK 539

Vekt kg	Zone 1	Zone 2	Zone 3	Zone 4	Zone 5	Zone 6	Zone 7	Zone 8	Zone 9	Zone 10	Zone 11	Zone 12	Zone 13	Zone 14	Zone 15	Zone 16	Zone 17	Zone 18	Zone 19	Zone 20
1	539	539	539	539	539	539	539	539	539	541	564	590	611	635	710	786	862	940	1012	1089
2	539	539	539	539	539	539	539	539	540	564	592	615	639	662	740	815	891	965	1041	1119
3	539	539	539	539	539	539	539	539	564	590	615	640	667	694	770	846	920	995	1072	1143
5	539	539	539	539	539	539	550	577	605	632	659	689	717	743	815	886	952	1024	1092	1163
7	539	539	539	539	539	561	592	618	649	676	705	729	760	787	857	921	991	1057	1125	1190
10	539	539	539	553	579	605	636	662	692	717	744	775	802	829	896	969	1039	1110	1177	1246
15	540	557	576	598	623	653	681	710	739	769	795	827	855	885	951	1023	1091	1162	1232	1300
20	553	581	611	640	675	705	736	769	798	830	861	892	924	956	1028	1098	1172	1243	1315	1387
25	565	614	659	708	743	783	820	857	892	929	967	1004	1041	1081	1163	1248	1332	1417	1502	1586
30	579	638	694	753	794	836	879	921	965	1006	1048	1090	1135	1175	1276	1379	1480	1580	1684	1785
35	598	668	743	821	869	920	969	1022	1071	1117	1168	1216	1267	1315	1428	1538	1647	1759	1870	1981
40	607	693	782	863	920	977	1031	1086	1141	1194	1248	1303	1359	1414	1542	1670	1796	1926	2054	2182
50	622	717	811	907	969	1031	1091	1157	1216	1273	1340	1400	1462	1523	1669	1812	1957	2098	2246	2388
60	636	740	846	947	1020	1086	1157	1222	1293	1357	1426	1494	1565	1633	1793	1952	2116	2276	2434	2598
70	651	766	878	994	1068	1141	1216	1292	1363	1438	1514	1586	1660	1736	1907	2079	2250	2422	2594	2765
80	667	787	911	1037	1117	1196	1276	1357	1438	1517	1596	1678	1756	1837	2023	2202	2386	2570	2751	2934
90	694	801	937	1073	1158	1251	1357	1424	1511	1623	1700	1812	1872	1942	2131	2327	2521	2715	2908	3105
100	723	809	950	1103	1197	1303	1433	1550	1618	1740	1818	1982	2038	2151	2260	2463	2664	2868	3070	3271
120	765	876	1035	1221	1347	1448	1616	1739	1865	2009	2153	2281	2422	2570	2714	2922	3067	3271	3479	3761
140	830	952	1160	1387	1529	1679	1824	1988	2153	2298	2464	2612	2776	2943	3127	3357	3543	3750	3995	4175
160	933	1096	1326	1574	1739	1903	2092	2257	2422	2612	2799	2961	3147	3357	3543	3814	4020	4268	4536	4722
180	995	1199	1471	1759	1926	2132	2342	2570	2776	2983	3211	3401	3625	3855	4101	4317	4612	4775	5115	5373
200	1037	1288	1555	1844	2053	2257	2486	2714	2943	3171	3401	3625	3829	4083	4350	4681	4931	5142	5434	5714
225	1080	1326	1616	1947	2116	2342	2586	2838	3043	3294	3543	3770	4020	4288	4496	4891	5139	5509	5861	6097
250	1138	1367	1679	2031	2217	2446	2690	2943	3190	3437	3691	3934	4162	4433	4703	5072	5366	5717	6110	6445

Vekt kg	Zone 1	Zone 2	Zone 3	Zone 4	Zone 5	Zone 6	Zone 7	Zone 8	Zone 9	Zone 10	Zone 11	Zone 12	Zone 13	Zone 14	Zone 15	Zone 16	Zone 17	Zone 18	Zone 19	Zone 20
275	1243	1491	1804	2176	2358	2631	2922	3171	3437	3691	3979	4249	4496	4784	5072	5509	5779	6170	6588	6958
300	1326	1595	1926	2342	2525	2838	3107	3401	3691	3979	4268	4536	4826	5158	5469	5882	6197	6630	7042	7457
350	1448	1739	2153	2570	2838	3127	3437	3750	4061	4389	4722	5034	5342	5698	6030	6527	6899	7354	7807	8309
400	1616	1947	2342	2838	3067	3420	3770	4123	4454	4826	5158	5534	5882	6278	6630	7168	7561	8080	8598	9156
500	1696	2053	2486	3006	3254	3647	4020	4371	4763	5116	5509	5861	6233	6630	7042	7584	7995	8556	9094	9718
600	1865	2257	2734	3294	3604	3995	4389	4808	5219	5637	6030	6425	6855	7291	7725	8350	8828	9382	10027	10669
700	2092	2507	3067	3691	4020	4454	4908	5366	5822	6294	6714	7168	7644	8163	8620	9300	9818	10503	11187	11911
800	2298	2752	3334	4020	4371	4868	5366	5861	6360	6855	7354	7833	8350	8909	9406	10171	10729	11475	12222	13030
900	2403	2943	3586	4288	4661	5179	5698	6233	6754	7272	7807	8309	8863	9406	9982	10751	11371	12140	12926	13737
1001	2472	3032	3749	4368	4769	5390	6027	6414	7052	7672	8077	8500	9330	9737	10375	11206	11824	12654	13273	14315
1100	2581	3144	3912	4559	4983	5626	6293	6695	7362	8008	8431	8878	9744	10164	10832	11699	12344	13212	13855	14945
1200	2817	3300	4269	4972	5436	6142	6863	7304	8029	8735	9199	9680	10627	11091	11814	12760	13468	14412	15115	16305
1300	3051	3576	4624	5388	5888	6649	7435	7914	8701	9462	9968	10488	11512	12014	12800	13824	14586	15612	16375	17663
1400	3288	3851	4981	5800	6340	7163	8010	8525	9371	10191	10728	11294	12400	12937	13787	14888	15712	16814	17636	19024
1500	3426	4016	5195	6049	6611	7317	8046	8609	9480	10216	10897	11640	12639	13353	14223	15376	16232	17228	18238	19684
1600	3566	4179	5409	6298	6883	7471	8082	8692	9588	10171	11065	11984	12877	13768	14660	15863	16751	17642	18839	20344
1700	3790	4440	5742	6692	7314	7935	8586	9239	10186	10810	11754	12733	13681	14629	15576	16852	17796	18747	20019	21615
1800	4016	4704	6083	7087	7745	8404	9094	9782	10785	11445	12447	13482	14485	15489	16493	17841	18848	19848	21193	22891
1900	4236	4965	6420	7477	8178	8870	9597	10326	11387	12079	13139	14232	15289	16349	17409	18832	19892	20950	22374	24162
2000	4459	5223	6556	7874	8278	8987	9720	10626	11566	12332	13448	14563	15713	16826	17944	19092	20205	21322	23201	24663
2100	4681	5489	6658	8267	8632	9437	10206	11159	12143	12950	14121	15289	16499	17666	18838	20045	21217	22384	24363	25899
2200	4905	5747	6977	8662	9046	9885	10692	11687	12725	13569	14792	16019	17287	18508	19739	20999	22225	23454	25523	27132
2300	5127	6009	7291	9054	9456	10332	11179	12220	13302	14184	15467	16748	18068	19352	20634	21955	23239	24518	26680	28366
2400	5352	6274	7606	9280	9611	10616	11495	12753	13878	14797	16137	17473	18854	20194	21533	22910	24247	25584	27842	29600
2500	5412	6427	7923	9451	9840	10756	11671	13063	14023	14980	16374	17769	19159	20599	21948	23387	25257	26175	28045	29917
2600	5599	6642	8648	10320	10738	11739	12743	14286	15333	16375	17883	19426	20933	22517	23980	25569	27615	28620	30621	32669

Vekt kg	Zone 1	Zone 2	Zone 3	Zone 4	Zone 5	Zone 6	Zone 7	Zone 8	Zone 9	Zone 10	Zone 11	Zone 12	Zone 13	Zone 14	Zone 15	Zone 16	Zone 17	Zone 18	Zone 19	Zone 20
2700	5815	6897	8980	10714	11149	12190	13231	14836	15923	17008	18565	20171	21735	23384	24901	26550	28676	29716	31798	33923
2800	6027	7151	9315	11113	11563	12645	13723	15386	16510	17636	19256	20920	22543	24249	25822	27535	29740	30819	32977	35183
2900	6244	7408	9644	11510	11975	13094	14216	15935	17101	18265	19942	21669	23345	25113	26746	28521	30802	31919	34155	36439
3000	6332	7511	9777	11669	12140	13273	14408	16155	17339	18519	20219	21964	23668	25462	27116	28910	31226	32355	34626	36939
3100	6542	7761	10104	12056	12544	13715	14888	16694	17914	19136	20892	22697	24456	26313	28019	29874	32266	33438	35780	38173
3200	6752	8013	10431	12446	12952	14161	15368	17233	18492	19751	21566	23427	25246	27161	28925	30837	33311	34518	36936	39404
3300	6965	8262	10758	12836	13357	14602	15850	17772	19072	20370	22241	24163	26033	28009	29827	31800	34351	35595	38089	40634
3400	7175	8512	11081	13225	13758	15044	16329	18311	19647	20988	22914	24894	26825	28856	30731	32769	35387	36673	39241	41865
3500	7386	8763	11407	13613	14165	15486	16807	18851	20226	21603	23589	25630	27613	29705	31636	33728	36430	37755	40400	43099
3600	7594	9014	11735	14000	14571	15928	17290	19386	20802	22220	24262	26361	28402	30554	32536	34693	37472	38830	41553	44330
3700	7806	9264	12061	14390	14974	16373	17770	19925	21383	22839	24935	27093	29190	31403	33441	35656	38510	39910	42706	45564
3800	8020	9513	12386	14778	15380	16814	18251	20466	21961	23456	25609	27825	29975	32252	34347	36618	39554	40986	43858	46795
3900	8230	9764	12710	15168	15779	17257	18731	21000	22536	24072	26284	28556	30765	33102	35250	37586	40591	42067	45014	48024
4000	8440	10016	13040	15559	16184	17696	19209	21540	23116	24690	26959	29290	31554	33949	36153	38549	41636	43147	46168	49256
4100	8651	10266	13363	15947	16595	18143	19692	22078	23693	25308	27633	30020	32346	34798	37056	39512	42673	44224	47322	50485
4200	8862	10514	13690	16334	16999	18585	20169	22621	24270	25925	28307	30753	33131	35646	37961	40474	43714	45302	48479	51718
4300	9071	10764	14017	16724	17399	19028	20650	23158	24851	26544	28979	31485	33921	36497	38865	41440	44755	46378	49632	52949
4400	9284	11015	14343	17115	17807	19471	21131	23694	25429	27161	29655	32219	34708	37343	39769	42402	45797	47459	50786	54178
4500	9493	11267	14664	17501	18209	19911	21612	24233	26004	27776	30327	32950	35501	38192	40674	43366	46837	48539	51940	55410
4600	9708	11517	14992	17892	18613	20353	22091	24769	26582	28396	31003	33682	36288	39041	41578	44330	47880	49616	53093	56643
4700	9919	11766	15318	18282	19023	20798	22572	25311	27162	29012	31676	34415	37081	39890	42482	45292	48920	50695	54248	57874
4800	10128	12017	15645	18668	19425	21238	23055	25848	27737	29628	32349	35146	37869	40738	43385	46258	49961	51773	55402	59105
4900	10339	12269	15972	19058	19828	21681	23535	26388	28314	30244	33024	35877	38655	41587	44288	47222	51003	52853	56558	60338
5000	10550	12515	16299	19445	20235	22126	24013	26927	28897	30862	33696	36610	39445	42439	45190	48185	52043	53934	57713	61569
Unit interval after 5000	227	270	350	419	437	476	515	579	619	662	726	787	849	911	970	1037	1120	1160	1241	1324

3.5.3 Business pallet

Zone	1 pallet	2 pallet	3 pallet	4 pallet	5 pallet	6 pallet	7 pallet	8 pallet	9 pallet	10 pallet	11 pallet	12 pallet
1	1096	782	723	688	662	653	634	615	611	607	604	601
2	1323	937	846	807	782	767	740	719	715	712	710	706
3	1589	1132	1095	1040	957	926	900	871	867	863	860	857
4	1928	1365	1276	1213	1189	1131	1096	1064	1059	1055	1046	1041
5	2083	1484	1393	1325	1241	1171	1137	1102	1095	1090	1085	1082
6	2323	1653	1574	1438	1356	1293	1255	1218	1212	1208	1199	1193
7	2558	1824	1761	1556	1466	1400	1359	1316	1311	1307	1297	1292
8	2800	1990	1874	1674	1603	1552	1505	1462	1454	1445	1439	1433
9	3027	2159	2061	1845	1746	1690	1640	1589	1580	1572	1563	1559
10	3275	2328	2242	1958	1864	1801	1748	1696	1689	1679	1670	1663
11	3502	2498	2357	2130	2031	1966	1903	1849	1839	1828	1817	1813
12	3756	2658	2484	2306	2199	2128	2064	2002	1988	1978	1966	1962
13	3994	2835	2727	2478	2373	2297	2228	2160	2149	2137	2125	2119
14	4262	3023	2760	2599	2539	2459	2383	2312	2299	2286	2273	2267
15	4500	3193	2943	2765	2708	2622	2542	2465	2454	2439	2428	2418
16	4867	3452	3178	2989	2883	2788	2704	2625	2611	2599	2583	2574
17	5135	3643	3353	3160	3049	2953	2862	2776	2760	2748	2732	2721
18	5487	3895	3588	3328	3219	3113	3022	2930	2916	2901	2886	2871
19	5839	4149	3764	3555	3502	3390	3288	3190	3173	3157	3141	3124
20	6217	4422	4061	3840	3722	3603	3496	3390	3372	3353	3335	3322

Prices per pallet

3.5.4 Additional services for goods

	Price
Notification	323
Rental of equipment (mobile crane, etc.)	Per hour
Driver calls	30
Labelling	153
Freight paid by recipient	358
Freight paid by third party	326
Manual EDI	157
Returned pallet and packaging	By agreement
Special delivery terms (Desktop Delivery)	By agreement
Special goods	25% addition of net customer freight
Dangerous goods	25% addition of net customer freight
Temperature-controlled goods	25% addition of net customer freight

Surcharge for goods

	Price
Notification	323
Second delivery	730
Incorrect address	77
Small collection	496
Credit fee	207
Error/missing EDI	157
Warehousing costs (warehouse rental in excess of 2 business days per day or part thereof)	NOK 75 per 100 kg, min. NOK 150
Incorrect weight/dimensions	55
Return/Redirection	572 per consignment
Wrong customer number	1010 per hour
Additional work/work by agreement	1219

Incomplete packaging

Volume in dm3:	0-30	31-200	201-500	501-999999
Price	142	285	427	569



Terminals

Place	Street address	Postcode	Place	Telephone
Alta	Betongveien 4	9509	Alta	04045
Bergen (parcels)	Kanalvegen 52 B	5068	Bergen	04045
Bergen (goods)	Nøstegaten 28	5010	Bergen	04045
Drammen	Terminalen 4	3414	Lier	04045
Fauske	Terminalveien 1	8208	Fauske	04045
Fredrikstad	Evjebekkveien 3	1661	Rolvsøy	04045
Førde	Moøyane 8	6819	Førde	04045
Hamar	Smiuhagan 10	2323	Ingeberg	04045
Harstad	Stangnesterterminalen 6	9409	Harstad	04045
Haugesund	Stølsmyr 10	5542	Karmsund	04045
Kongsvinger	Industriveien 15	2212	Kongsvinger	04045
Kristiansand	Snelldalen 3	4770	Høvåg	04045
Leknes	Lufthavnveien 8	8370	Leknes	04045

Place	Street address	Postcode	Place	Telephone
Mo i Rana	Nordregate 13-17	8622	Mo i Rana	04045
Molde	Gammelseterlia 22	6422	Molde	04045
Narvik	Medbymoene 3	8530	Bjerkvik	04045
Oslo	Alfasetveien 24	0668	Oslo	04045
Otta	Skansen 33	2670	Otta	04045
Sortland	Verkstedveien 7	8402	Sortland	04045
Stavanger	Vagleveien 35	4323	Sandnes	04045
Stokke	Borgeskogen 57 G	3160	Stokke	04045
Tana	Grenveien 5	9845	Tana	04045
Tromsø	Stakkevollvegen 317	9019	Tromsø	04045
Trondheim	Torgardstrøa 18	7093	Tiller	04045
Ålesund	Digerneset Næringspark	6260	Skodje	04045



Contact us

bring.no/en/customer-service/contact-us

Opening hours:

Monday – Friday: 08:00-16:00



Posten Bring AS, Postboks 1500 Sentrum, NO-0001 Oslo.

Telephone: (+47) 23 14 90 00, bring.no

Org. no. 984661185

MM-002-01-2025

Subject to reservation for any printing errors and price changes